

» Kontron User's Guide «

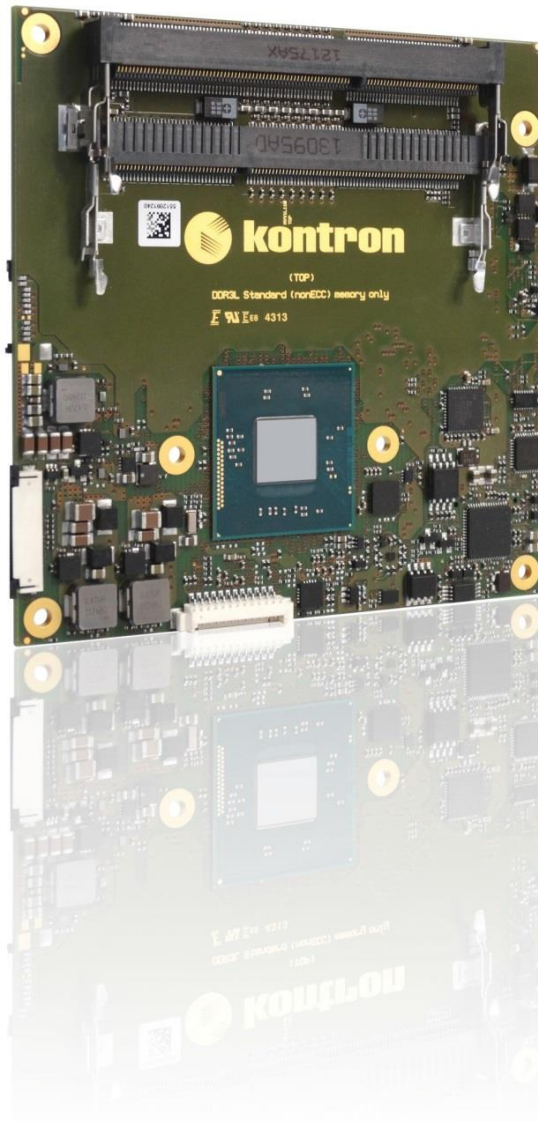

COMe-cBT6 User Guide

Doc. Rev. 2.3

This page has been intentionally left blank

Disclaimer

Kontron would like to point out that the information contained in this user guide may be subject to alteration, particularly as a result of the constant upgrading of Kontron products. This document does not entail any guarantee on the part of Kontron with respect to technical processes described in the user guide or any product characteristics set out in the user guide. Kontron assumes no responsibility or liability for the use of the described product(s), conveys no license or title under any patent, copyright or mask work rights to these products and makes no representations or warranties that these products are free from patent, copyright or mask work right infringement unless otherwise specified. Applications that are described in this user guide are for illustration purposes only. Kontron makes no representation or warranty that such application will be suitable for the specified use without further testing or modification. Kontron expressly informs the user that this user guide only contains a general description of processes and instructions which may not be applicable in every individual case. In cases of doubt, please contact Kontron.

This user guide is protected by copyright. All rights are reserved by Kontron. No part of this document may be reproduced, transmitted, transcribed, stored in a retrieval system, or translated into any language or computer language, in any form or by any means (electronic, mechanical, photocopying, recording, or otherwise), without the express written permission of Kontron. Kontron points out that the information contained in this user guide is constantly being updated in line with the technical alterations and improvements made by Kontron to the products and thus this user guide only reflects the technical status of the products by Kontron at the time of publishing.

Brand and product names are trademarks or registered trademarks of their respective owners.

©2019 by Kontron S&T AG

Kontron S&T AG
Lise-Meitner-Str. 3-5
86156 Augsburg
Germany
www.kontron.com

Intended Use

THIS DEVICE AND ASSOCIATED SOFTWARE ARE NOT DESIGNED, MANUFACTURED OR INTENDED FOR USE OR RESALE FOR THE OPERATION OF NUCLEAR FACILITIES, THE NAVIGATION, CONTROL OR COMMUNICATION SYSTEMS FOR AIRCRAFT OR OTHER TRANSPORTATION, AIR TRAFFIC CONTROL, LIFE SUPPORT OR LIFE SUSTAINING APPLICATIONS, WEAPONS SYSTEMS, OR ANY OTHER APPLICATION IN A HAZARDOUS ENVIRONMENT, OR REQUIRING FAIL-SAFE PERFORMANCE, OR IN WHICH THE FAILURE OF PRODUCTS COULD LEAD DIRECTLY TO DEATH, PERSONAL INJURY, OR SEVERE PHYSICAL OR ENVIRONMENTAL DAMAGE (COLLECTIVELY, "HIGH RISK APPLICATIONS").

You understand and agree that your use of Kontron devices as a component in High Risk Applications is entirely at your risk. To minimize the risks associated with your products and applications, you should provide adequate design and operating safeguards. You are solely responsible for compliance with all legal, regulatory, safety, and security related requirements concerning your products. You are responsible to ensure that your systems (and any Kontron hardware or software components incorporated in your systems) meet all applicable requirements. Unless otherwise stated in the product documentation, the Kontron device is not provided with error-tolerance capabilities and cannot therefore be deemed as being engineered, manufactured or setup to be compliant for implementation or for resale as device in High Risk Applications. All application and safety related information in this document (including application descriptions, suggested safety measures, suggested Kontron products, and other materials) is provided for reference only.

Revision History

Version	Brief Description of Change	Date of Issue
110	Initial version	-
2.0	Updated memory accessories	2019-Sept-17
2.1	Updated Carrier Accessories	2020-Jul-23
2.2	Updated Block Diagram, UL listings, eMMC information, CPU specification and Storage Onboard SSD information.	2020-Sept-17
2.3	Updated block Diagram, Ethernet chip Intel®i210ATreplacing i211AT in Yr2022 and AES-NI is no longer optional.	2022-Apr-22
2.4	Added MTBF-value	2025-Jan-23

Terms and Conditions

Kontron warrants products in accordance with defined regional warranty periods. For more information about warranty compliance and conformity, and the warranty period in your region, visit <http://www.kontron.com/terms-and-conditions>.

Kontron sells products worldwide and declares regional General Terms & Conditions of Sale, and Purchase Order Terms & Conditions. Visit <http://www.kontron.com/terms-and-conditions>.

For contact information, refer to the corporate offices contact information on the last page of this user guide or visit our website [CONTACT US](#).

Customer Support

Find Kontron contacts by visiting: <http://www.kontron.com/support>.

Customer Service

As a trusted technology innovator and global solutions provider, Kontron extends its embedded market strengths into a services portfolio allowing companies to break the barriers of traditional product lifecycles. Proven product expertise coupled with collaborative and highly-experienced support enables Kontron to provide exceptional peace of mind to build and maintain successful products.

For more details on Kontron's service offerings such as: enhanced repair services, extended warranty, Kontron training academy, and more visit <http://www.kontron.com/support-and-services/services>.

Customer Comments

If you have any difficulties using this user guide, discover an error, or just want to provide some feedback, contact [Kontron support](#). Detail any errors you find. We will correct the errors or problems as soon as possible and post the revised user guide on our website.

» Table of Contents «

Disclaimer	3
Intended Use	4
Revision History	5
Terms and Conditions	5
Customer Support	5
Customer Service	5
Customer Comments.....	5
1. User Information	8
1.1. About This Document.....	8
1.2. Copyright Notice.....	8
1.3. Trademarks	8
2. Introduction.....	9
2.1. Product Description.....	9
2.2. Naming clarification	9
2.3. Understanding COM Express® Functionality	9
2.4. COM Express® Documentation	10
2.5. COM Express® Benefits	10
3. Product Specification.....	11
3.1. Modules Definition	11
3.2. Functional Specification	12
3.3. Block Diagram.....	16
3.4. Accessories	17
3.5. Electrical Specification.....	18
3.5.1. Supply Voltage	18
3.5.2. Power Supply Rise Time	18
3.5.3. Supply Voltage Ripple.....	18
3.5.4. Power Consumption.....	18
3.5.5. ATX Mode	19
3.5.6. Single Supply Mode.....	19
3.6. Power Control	20
3.6.1. Power Supply	20
3.6.2. Power Button (PWRBTN#)	20
3.6.3. Power Good (PWR_OK).....	20
3.6.4. Reset Button (SYS_RESET#).....	20
3.6.5. SM-Bus Alert (SMB_ALERT#)	20

3.7. Environmental Specification	20
3.7.1. Temperature Specification	20
3.7.2. Humidity	20
3.8. Standards and Certifications	21
3.9. MTBF.....	23
3.10. Mechanical Specification	24
3.11. Module Dimensions	25
3.12. Onboard Fan Connector	26
3.13. Thermal Management, Heatspreader and Cooling Solutions	27
4. Features and Interfaces	28
4.1. Onboard eMMC Flash.....	28
4.2. S5 Eco Mode	29
4.3. LPC 30	
4.4. Serial Peripheral Interface (SPI).....	31
4.5. SPI boot.....	31
4.6. M.A.R.S.	33
4.7. UART.....	34
4.8. Fast I2C	35
4.9. Dual Staged Watchdog Timer	36
4.10. Speedstep Technology.....	37
4.11. C-States	40
4.12. Graphics Features.....	41
4.13. ACPI Suspend Modes and Resume Events	42
4.14. USB	43
5. System Resources	44
5.1. Interrupt Request (IRQ) Lines	44
5.2. Memory Area.....	44
5.3. I/O Address Map	45
5.4. Peripheral Component Interconnect (PCI) Devices.....	46
5.5. LPC addresses	46
5.6. I2C Bus.....	46
5.7. System Management (SM) Bus	47
6. Pinout List.....	48
6.1. General Signal Description	48
6.2. Connector X1A Row A	49
6.3. Connector X1A Row B	51
6.4. Connector X1B Row C	53
6.5. Connector X1B Row D.....	55
7. BIOS Operation	57

7.1. Determining the BIOS Version	57
7.2. BIOS Update	57
7.3. POST Codes	58
7.4. Setup Guide	58
7.5. BIOS Setup	59
7.5.1. Main	59
7.5.2. Advanced	64
7.5.3. Security	87
7.5.4. Boot	88
7.5.5. Exit	89
About Kontron	90

1. User Information

1.1. About This Document

This document provides information about products from Kontron and/or its subsidiaries. No warranty of suitability, purpose, or fitness is implied. While every attempt has been made to ensure that the information in this document is accurate, the information contained within is supplied "as-is" and is subject to change without notice.

For the circuits, descriptions and tables indicated, Kontron assumes no responsibility as far as patents or other rights of third parties are concerned.

1.2. Copyright Notice

Copyright © 2003-2014 Kontron

All rights reserved. No part of this document may be reproduced, transmitted, transcribed, stored in a retrieval system, or translated into any language or computer language, in any form or by any means (electronic, mechanical, photocopying, recording, or otherwise), without the express written permission of Kontron.

DIMM-PC®, PISA®, ETX®, ETXexpress®, microETXexpress®, X-board®, DIMM-IO® and DIMM-BUS® are trademarks or registered trademarks of Kontron.

1.3. Trademarks

The following lists the trademarks of components used in this board.

- » IBM, XT, AT, PS/2 and Personal System/2 are trademarks of International Business Machines Corp.
- » Microsoft is a registered trademark of Microsoft Corp.
- » Intel is a registered trademark of Intel Corp.
- » All other products and trademarks mentioned in this manual are trademarks of their respective owner

2. Introduction

2.1. Product Description

The standard design of the COM Express® compact modules – Kontron COMe-cBT6 – supports the entire portfolio of the Intel® Atom™ E3800 processors (COMe-cBTi6) and Intel® Celeron® processors N2800/N2900 and J1900 (COMe-cBTc6), whereby the E3800 variants are designed for the extended temperature range of -40°C to +85°C. The memory of up to 2x 8GB has been laid out as dual-channel DDR3L SODIMM. With eMMC Flash and 2x SATA, ample storage options for OS and application code are available. Substantial USB support is also offered with 1x USB 3.0 and up to 8x USB 2.0.

2.2. Naming clarification

COM Express® defines a Computer-On-Module, or COM, with all components necessary for a bootable host computer, packaged as a super component.

- » COMe-bXX# modules are Kontron's COM Express® modules in basic form factor (125mm x 95mm)
- » COMe-cXX# modules are Kontron's COM Express® modules in compact form factor (95mm x 95mm)
- » COMe-mXX# modules are Kontron's COM Express® modules in mini form factor (55mm x 84mm)

The product names for Kontron COM Express® Computer-on-Modules consist of a short form of the industry standard (**COMe-**), the form factor (**b**=basic, **c**=compact, **m**=mini), the capital letters for the CPU and Chipset Codenames (**XX**) and the pin-out type (**#**) followed by the CPU Name.

2.3. Understanding COM Express® Functionality

All Kontron COM Express® basic and compact modules contain two 220pin connectors; each of it has two rows called Row A & B on primary connector and Row C & D on secondary connector. COM Express® Computer-on-modules feature the following maximum amount of interfaces according to the PICMG module Pin-out type:

Feature	Pin-Out Type 1	Pin-Out Type 10	Pin-Out Type 2	Pin-Out Type 6
HD Audio	1x	1x	1x	1x
Gbit Ethernet	1x	1x	1x	1x
Serial ATA	4x	4x	4x	4x
Parallel ATA	-	-	1x	-
PCI	-	-	1x	-
PCI Express x1	6x	6x	6x	8x
PCI Express x16 (PEG)	-	-	1x	1x
USB Client	1x	1x	-	-
USB 2.0	8x	8x	8x	8x
USB 3.0	-	2x	-	4x
VGA	1x	-	1x	1x
LVDS	Dual Channel	Single Channel	Dual Channel	Dual Channel
DP++ (SDVO/DP/HDMI/DVI)	1x optional	1x	3x shared with PEG	3x
LPC	1x	1x	1x	1x
External SMB	1x	1x	1x	1x
External I2C	1x	1x	1x	1x
GPIO	8x	8x	8x	8x
SDIO shared w/GPIO	1x optional	1x optional	-	1x optional
UART (2-wire COM)	-	2x	-	2x
FAN PWM out	-	1x	-	1x

2.4. COM Express® Documentation

This product manual serves as one of three principal references for a COM Express® design. It documents the specifications and features of COMe-cBT6. Additional references are available at your Kontron Support or at PICMG®:

- » The COM Express® Specification defines the COM Express® module form factor, pin-out, and signals. This document is available at the PICMG® website by filling out the order form.
- » The COM Express® Design Guide by PICMG® serves as a general guide for baseboard design, with a focus on maximum flexibility to accommodate a wide range of COM Express® modules.



Some of the information contained within this product manual applies only to certain product revisions (CE: xxx). If certain information applies to specific product revisions (CE: xxx) it will be stated. Please check the product revision of your module to see if this information is applicable.

2.5. COM Express® Benefits

COM Express® modules are very compact, highly integrated computers. All Kontron COM Express® modules feature a standardized form factor and a standardized connector layout which carry a specified set of signals. Each COM is based on the COM Express® specification. This standardization allows designers to create a single-system baseboard that can accept present and future COM Express® modules.

The baseboard designer can optimize exactly how each of these functions implements physically. Designers can place connectors precisely where needed for the application on a baseboard designed to optimally fit a system's packaging.

A single baseboard design can use a range of COM Express® modules with different sizes and pin-outs. This flexibility can differentiate products at various price/performance points, or when designing future proof systems that have a built-in upgrade path. The modularity of a COM Express® solution also ensures against obsolescence when computer technology evolves. A properly designed COM Express® baseboard can work with several successive generations of COM Express® modules.

A COM Express® baseboard design has many advantages of a customized computer-board design and, additionally, delivers better obsolescence protection, heavily reduced engineering effort, and faster time to market

3. Product Specification

3.1. Modules Definition

The COM Express® compact sized Computer-on-Module COMe-cBT6 (CVV6) follows pin-out Type 6 and is compatible to PICMG specification COM.0 Rev 2.1. The COMe-cBT6, based on Intel's Bay Trail platform, is available in different variants to cover the demand of different performance, price and power:

Industrial temperature grade modules (E2: -40°C to +85°C operating)

Part Number	Product Name	Processor	Memory	eMMC	TPM	Ethernet	USB 2.0
36015-0016-19-4	COMe-cBTi6 E3845 16GB	Intel® Atom E3845	2x SODIMM	16GB MLC	YES	Intel® i210IT	8x
36015-0000-19-4	COMe-cBTi6 E3845	Intel® Atom E3845	2x SODIMM	-	-	Intel® i210IT	8x
36015-0000-17-2	COMe-cBTi6 E3827	Intel® Atom E3827	2x SODIMM	-	-	Intel® i210IT	8x
36015-0000-15-2	COMe-cBTi6 E3826	Intel® Atom E3826	2x SODIMM	-	-	Intel® i210IT	8x
36015-0000-13-2	COMe-cBTi6 E3825	Intel® Atom E3825	1x SODIMM	-	-	Intel® i210IT	8x
36015-0000-15-1	COMe-cBTi6 E3815	Intel® Atom E3815	1x SODIMM	-	-	Intel® i210IT	8x

Commercial temperature grade modules (0°C to +60°C operating)

Part Number	Product Name	Processor	Memory	eMMC	TPM	Ethernet	USB 2.0
36017-0000-20-4	COMe-cBTc6 J1900	Intel® Celeron J1900	2x SODIMM	-	-	Intel® i210AT	4x
36017-0000-18-4	COMe-cBTc6 N2930	Intel® Celeron N2930	2x SODIMM	-	-	Intel® i210AT	4x
36017-0000-16-2	COMe-cBTc6 N2807	Intel® Celeron N2807	1x SODIMM	-	-	Intel® i210AT	4x
36017-0000-15-1	COMe-cBTc6 E3815	Intel® Atom E3815	1x SODIMM	-	-	Intel® i210AT	4x

Onboard Flash configurations, available on E3800 variants only (36015-00FF-xx-x)

- » FF = 00: without eMMC Flash
- » FF = 20: 2GB onboard eMMC Flash
- » FF = 40: 4GB onboard eMMC Flash
- » FF = 80: 8GB onboard eMMC Flash
- » FF = 16: 16GB onboard eMMC Flash
- » FF = 32: 32GB onboard eMMC Flash
- » FF = 64: 64GB onboard eMMC Flash

Optional hardware features for E3800 Series CPU

- » TPM
- » eMMC Flash
- » eDP on COMe

Optional hardware features for Celeron Series CPU

- » TPM
- » eDP on COMe
- » USB Hub for USB #4-7 support on COMe

Optional BIOS/Software features:

- » TXE Firmware with Encryption support (AES, PAVP ...)



Optional hardware and BIOS features are available project based only for variants not listed above. Please contact your local sales for customized articles.

3.2. Functional Specification

Processor

The 32nm Intel® Atom™ E3800 / Celeron® (BayTrail-I/M/D) CPU family supports:

- » Intel® 64
- » Enhanced Intel SpeedStep® Technology
- » Thermal Monitoring Technologies
- » Execute Disable Bit
- » Virtualization Technology VT-x
- » 2 Display Pipes for dual independent displays

CPU specifications

Intel®	Atom™	Atom™	Atom™	Atom™	Atom™	Atom™	Celeron®	Celeron®	Celeron®
-	E3845	E3827	E3826	E3825	E3815	E3805	J1900	N2930	N2807
# of Cores	4	2	2	2	1	2	4	4	2
# of Threads	4	2	2	2	1	2	4	4	2
CPU Nominal frequency	1.91GHz	1.75GHz	1.46GHz	1.33GHz	1.46GHz	1.33GHz	2.00GHz	1.83GHz	1.58GHz
CPU Burst frequency	-	-	-	-	-	-	2.42GHz	2.16GHz	2.16GHz
LFM/LPM Frequency	533MHz	533MHz	533MHz	533MHz	533MHz	533MHz	1333MHz	500MHz	533MHz
Tjunction	110°C	110°C	110°C	110°C	110°C	110°C	105°C	105°C	105°C
Thermal Design Power (TDP)	10W	8W	7W	6W	5W	3W	10W	7.5W	4.3W
SDP	-	-	-	-	-	-	-	4.5W	2.5W
C-States	C1/C1E/C6	C1/C1E/C6	C1/C1E/C6	C1/C1E/C6	C1/C1E/C6	C1/C1E/C6	C1/C1E/C6	C1/C1E/C6/C7	C1/C1E/C6/C7
Smart Cache	2x1MB	2x512kB	2x512kB	2x512kB	512kB	512kB	2x1MB	2x1MB	2x512kB
Memory Type	DDR3L-1333	DDR3L-1333	DDR3L-1066	DDR3L-1066	DDR3L-1066	DDR3L-1066	DDR3L-1333	DDR3L-1333	DDR3L-1333
Max Memory Size	2x8GB	2x8GB	2x8GB	1x8GB	1x8GB	1x8GB	2x8GB	2x8GB	1x8GB
ECC Memory(optional)	Yes	Yes	Yes	Yes	Yes	Yes	No	No	No
Graphics Model	Intel HD®	Intel HD®	Intel HD®	Intel HD®	Intel HD®	-	Intel HD®	Intel HD®	Intel HD®
GFX Base Frequency	542MHz	542MHz	533MHz	533MHz	400MHz	-	688MHz	313MHz	313MHz
GFX Max Dynamic Frequ.	792MHz	792MHz	667MHz	-	-	-	854MHz	854MHz	750MHz
GFX Technology	GT1 4EU	GT1 4EU	GT1 4EU	GT1 4EU	GT1 4EU	-	GT1 4EU	GT1 4EU	GT1 4EU
SDIO	Yes	Yes	Yes	Yes	Yes	Yes	No	No	No
eMMC	Yes	Yes	Yes	Yes	Yes	Yes	No	No	No
AES-NI (optional)	Yes	Yes	Yes	Yes	Yes	Yes	No	No	No

Memory

Sockets	2x DDR3L SO-DIMM
Memory Type	DDR3L-1066/1333
Maximum Size	2x8GB
Technology	Dual Channel

Graphics Core

The integrated Intel® HD Graphics (Gen 7) supports:

Graphics Core Render Clock	Intel® HD Graphics (Gen 7) 311-542MHz Clock 667-854MHz Turbo
Execution Units / Pixel Pipelines	4
Max Graphics Memory	2048MB
GFX Memory Bandwidth (GB/s)	up to 21.3
GFX Memory Technology	DVMT
API (DirectX/OpenGL)	11/ 3.0 + OCL 1.1
Shader Model	3.0
Hardware accelerated Video	H.264 / MPEG1,2,4 / VC1 / WMV9 / Blu-ray
Independent/Simultaneous Displays	2
Display Port	DP 1.1a / eDP 1.3
HDCP support	HDCP / PAVP 2 (optional)

Monitor output

CRT max Resolution	2560x1600
TV out:	-

LVDS

LVDS Bits/Pixel	1x18/24, 2x18/24 with DP2LVDS
LVDS Bits/Pixel with dithering	-
LVDS max Resolution:	1920x1200
PWM Backlight Control:	YES
Supported Panel Data:	EDID/DID

Display Interfaces

Discrete Graphics	-
Digital Display Interface DDI1	DP++
Digital Display Interface DDI2	DP++ muxed with LVDS
Digital Display Interface DDI3	-
Maximum Resolution on DDI	2560x1600@60Hz

Storage

onboard SSD	2-64GB eMMC
IDE Interface	-
Serial-ATA	2x SATA 3Gb/s
SATA AHCI	AHCI with NCQ, HotPlug, Staggered Spinup,
SATA RAID	-

Connectivity

USB	up to 8x USB 2.0
USB 3.0	1x USB 3.0
USB Client	-
PCI	-
PCI External Masters	-
PCI Express	3x PCIe x1 Gen2
Max PCI Express	4x PCIe x1 without LAN
PCI Express x2/x4 configuration	YES
Ethernet	10/100/1000 Mbit
Ethernet controller	Intel® i210IT / i210AT

Feature OS Support Matrix

	Windows 8		Windows 7		WEC		Tizen	Fedora/Yocto		Android	
	E3800	Celeron	E3800	Celeron	E3800	Celeron	E3800	E3800	Celeron	E3800	Celeron
eMMC Storage	X	X	-	-	X	-	X	X	-	-	-
eMMC Boot	X	X	-	-	X	-	X	X	-	X	X
SD Storage	X	X	X	-	X	-	X	X	-	X	X
SD Boot	-	-	X	-	X	-	X	X	-	X	X
MIPI-CSI	-	-	-	-	-	-	-	X	-	-	-

PCI Express Configuration

By default, the COMe-cBT6 supports x1 PCIexpress lane configuration only (Configuration 0). Following x2/x4 configurations are available via Management Engine Softstrap Options with a customized Flash Descriptor.

PCIe	Port #0	Port #1	Port #2	Port #3
Default	x1	x1	x1	LAN
Configuration 1		x2	x1	x1
Configuration 2	x1	x1	x1	x1
Configuration 3		x2	x1	x1
Configuration 4		x2		x2
Configuration 5			x4	



Configuration 1 - 5 are available with customized BIOS versions only

Ethernet

The Intel® i210IT / i210AT ethernet supports:

- » Jumbo Frames
- » Time Sync Protocol Indicator
- » WOL (Wake On LAN)
- » PXE (Preboot eXecution Environment)

Misc Interfaces and Features

Supported BIOS Size/Type	8MB SPI
Audio	HD Audio
Onboard Hardware Monitor	Nuvoton NCT7802Y
Trusted Platform Module	Atmel AT97SC3204 optional
Miscellaneous	2x UART / PWM FAN

Kontron Features

External I2C Bus	Fast I2C, MultiMaster capable
M.A.R.S. support	YES
Embedded API	KEAPI3
Custom BIOS Settings / Flash Backup	YES
Watchdog support	Dual Staged

Additional features

- » All solid capacitors (POSCAP). No tantalum capacitors used.
- » Optimized RTC Battery monitoring to secure highest longevity
- » Real fast I2C with transfer rates up to 40kB/s.
- » Discharge logic on all onboard voltages for highest reliability

Power Features

Singly Supply Support	YES
Supply Voltage	4.75 - 20V
ACPI	ACPI 3.0
S-States	S0, S3, S4, S5
S5 Eco Mode	YES
Misc Power Management	DPST 4.0, iFFS

Power Consumption and Performance

Full Load Power Consumption	3.5 - 13.5W
Kontron Performance Index	9323 - 27747
Kontron Performance/Watt	1944 - 2986



Detailed Power Consumption measurements in all states and benchmarks for CPU, Graphics and Memory performance are available in Application Note [KEMAP054](#) at [EMD Customer Section](#).

3.3. Block Diagram

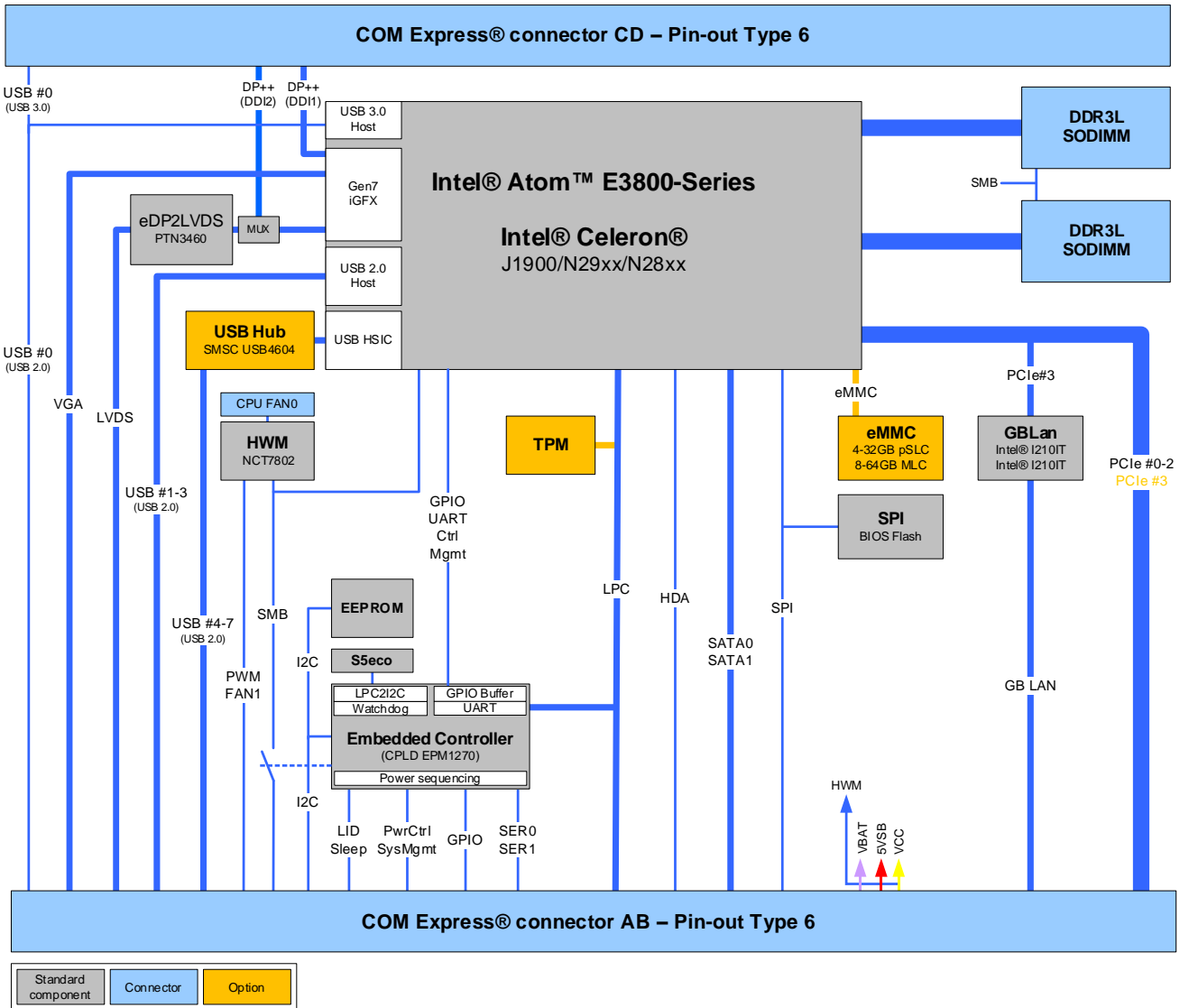

3.4. Accessories

Product specific accessories

Product Number	Heatspreader and Cooling Solutions	Comment
36015-0000-99-0	HSP COMe-cBT6 thread	For all CPUs and temperature grades
36015-0000-99-1	HSP COMe-cBT6 through	For all CPUs and temperature grades

General accessories

Part Number	COMe pin-out Type 6 compatible accessories	Project Code	Comment
38116-0000-00-5	COM Express® Eval Carrier2 Type 6	ADT6	ATX Carrier with 5mm COMe connector
96006-0000-00-2	COMe POST T6	NFCB	POST Code / Debug Card
38019-0000-00-0	ADA-COMe-Height-dual	EERC	Height Adapter
Part Number	Mounting	Comment	
38017-0000-00-5	COMe Mount KIT 5mm 1set	Mounting Kit for 1 module including screws for 5mm connectors	
38017-0100-00-5	COMe Mount KIT 5mm 100sets	Mounting Kit for 100 modules including screws for 5mm connectors	
38017-0000-00-0	COMe Mount KIT 8mm 1set	Mounting Kit for 1 module including screws for 8mm connectors	
38017-0100-00-0	COMe Mount Kit 8mm 100sets	Mounting Kit for 100 modules including screws for 8mm connectors	
Part Number	Cooling Solutions	Comment	
36099-0000-99-0	COMe Active Uni Cooler	for CPUs up to 20W TDP, to be mounted on HSP	
36099-0000-99-1	COMe Passive Uni Cooler	for CPUs up to 10W TDP, to be mounted on HSP	
Part Number	Cables	Comment	
96079-0000-00-0	KAB-HSP 200mm	Cable adapter to connect FAN to module (COMe basic/compact)	
96079-0000-00-2	KAB-HSP 40mm	Cable adapter to connect FAN to module (COMe basic/compact)	

Compatible Memory

Part Number	DDR3L SODIMM, commercial temperature grade
97015-2048-13-1	DDR3L-1333 SODIMM 2GB
97015-4096-13-1	DDR3L-1333 SODIMM 4GB
97015-8192-13-1	DDR3L-1333 SODIMM 8GB
Part Number	DDR3L SODIMM, industrial temperature grade
97015-2048-13-3	DDR3L-1333 SODIMM 2GB E2
97015-4096-13-3	DDR3L-1333 SODIMM 4GB E2
97015-8192-13-3	DDR3L-1333 SODIMM 8GB E2

3.5. Electrical Specification

3.5.1. Supply Voltage

Following supply voltage is specified at the COM Express® connector:

VCC:	4.75 - 20V
Standby:	5V DC +/- 5%
RTC:	2.5V - 3.47V



- 5V Standby voltage is not mandatory for operation.
- Extended Temperature (E1) variants are validated for 12V supply only

3.5.2. Power Supply Rise Time

- » The input voltages shall rise from $\leq 10\%$ of nominal to within the regulation ranges within 0.1ms to 20ms.
- » There must be a smooth and continuous ramp of each DC input voltage from 10% to 90% of its final set-point following the ATX specification

3.5.3. Supply Voltage Ripple

- » Maximum 100 mV peak to peak 0 – 20 MHz

3.5.4. Power Consumption

The maximum Power Consumption of the different COMe-cBT6 variants is 3.5 - 13.5W (100% CPU load on all cores; 90°C CPU temperature). Further information with detailed measurements are available in Application Note KEMAP054 available on [EMD Customer Section](#). Information there is available after registration.

3.5.5. ATX Mode

By connecting an ATX power supply with VCC and 5VSB, PWR_OK is set to low level and VCC is off. Press the Power Button to enable the ATX PSU setting PWR_OK to high level and powering on VCC. The ATX PSU is controlled by the PS_ON# signal which is generated by SUS_S3# via inversion. VCC can be 4.75 - 20V in ATX Mode. On Computer-on-Modules supporting a wide range input down to 4.75V the input voltage shall always be higher than 5V Standby (VCC > 5VSB).

State	PWRBTN#	PWR_OK	V5_StdBy	PS_ON#	VCC
G3	x	x	0V	x	0V
S5	high	low	5V	high	0V
S5 → S0	PWRBTN Event	low → high	5V	high → low	0 V → VCC
S0	high	high	5V	low	VCC

3.5.6. Single Supply Mode

In single supply mode (or automatic power on after power loss) without 5V Standby the module will start automatically when VCC power is connected and Power Good input is open or at high level (internal PU to 3.3V). PS_ON# is not used in this mode and VCC can be 4.75 - 20V.

To power on the module from S5 state press the power button or reconnect VCC. Suspend/Standby States are not supported in Single Supply Mode.

State	PWRBTN#	PWR_OK	V5_StdBy	VCC
G3	x	x	x	0
G3 → S0	high	open / high	x	connecting VCC
S5	high	open / high	x	VCC
S5 → S0	PWRBTN Event	open / high	x	reconnecting VCC



Signals marked with “x” are not important for the specific power state. There is no difference if connected or open.

All ground pins have to be tied to the ground plane of the carrier board.

3.6. Power Control

3.6.1. Power Supply

The COMe-cBT6 supports a power input from 4.75 - 20V. The supply voltage is applied through the VCC pins (VCC) of the module connector.

3.6.2. Power Button (PWRBTN#)

The power button (Pin B12) is available through the module connector described in the pinout list. To start the module via Power Button the PWRBTN# signal must be at least 50ms ($50\text{ms} \leq t < 4\text{s}$, typical 400ms) at low level (Power Button Event).

Pressing the power button for at least 4seconds will turn off power to the module (Power Button Override).

3.6.3. Power Good (PWR_OK)

The COMe-cBT6 provides an external input for a power-good signal (Pin B24). The implementation of this subsystem complies with the COM Express® Specification. PWR_OK is internally pulled up to 3.3V and must be high level to power on the module.

3.6.4. Reset Button (SYS_RESET#)

The reset button (Pin B49) is available through the module connector described in the pinout list. The module will stay in reset as long as SYS_RESET# is grounded. If available, the BIOS setting for "Reset Behavior" must be set to "Power Cycle".



Modules with Intel® Chipset and active Management Engine do not allow to hold the module in Reset out of S0 for a long time. At about 10s holding the reset button the ME will reboot the module automatically

3.6.5. SM-Bus Alert (SMB_ALERT#)

With an external battery manager present and SMB_ALERT# (Pin B15) connected the module always powers on even if BIOS switch "After Power Fail" is set to "Stay Off".

3.7. Environmental Specification

3.7.1. Temperature Specification

Kontron defines following temperature grades for Computer-on-Modules in general. Please see chapter 'Product Specification' for available temperature grades for the COMe-cBT6

Temperature Specification	Operating	Non-operating	Validated Input Voltage
Commercial grade	0°C to +60°C	-30°C to +85°C	VCC: 4.75 - 20V
Extended Temperature (E1)	-25°C to +75°C	-30°C to +85°C	VCC: 12V
Industrial grade by Screening (XT)	-40°C to +85°C	-40°C to +85°C	VCC: 12V
Industrial grade by Design (E2)	-40°C to +85°C	-40°C to +85°C	VCC: 4.75 - 20V

Operating with Kontron heatspreader plate assembly

The operating temperature defines two requirements:

- » the maximum ambient temperature with ambient being the air surrounding the module.
- » the maximum measurable temperature on any spot on the heatspreader's surface

Test specification:

Temperature Grade	Validation requirements
Commercial grade	at 60°C HSP temperature the CPU @ 100% load needs to run at nominal frequency
Extended Temperature (E1)	at 75°C HSP temperature the CPU @ 75% load is allowed to start speedstepping for thermal protection
Industrial grade by Screening (XT)	at 85°C HSP temperature the CPU @ 50% load is allowed to start throttling for thermal protection
Industrial grade by Design (E2)	at 85°C HSP temperature the CPU @ 50% load is allowed to start throttling for thermal protection

Operating without Kontron heatspreader plate assembly

The operating temperature is the maximum measurable temperature on any spot on the module's surface.

3.7.2. Humidity

- » 93% relative Humidity at 40°C, non-condensing (according to IEC 60068-2-78)

3.8. Standards and Certifications

RoHS II

The **COMe-cBT6** is compliant to the directive 2011/65/EU on the Restriction of the use of certain Hazardous Substances (RoHS II) in electrical and electronic equipment



UL 60950-1/CSA 60950-1 Component Recognition

Recognized by Underwriters Laboratories Inc. Representative samples of this component have been evaluated by UL and meet applicable UL requirements.

UL Listings:

- » AZOT2.E147705
- » AZOT8.E147705



WEEE Directive

WEEE Directive 2002/96/EC is not applicable for Computer-on-Modules.

Conformal Coating

Conformal Coating is available for Kontron Computer-on-Modules and for validated SO-DIMM memory modules. Please contact your local sales or support for further details.

Shock & Vibration

The **COM Express® compact** form factor Computer-on-Modules successfully passed shock and vibration tests according to

- » IEC/EN 60068-2-6 (Non operating Vibration, sinusoidal, 10Hz-4000Hz, +/-0.15mm, 2g)
- » IEC/EN 60068-2-27 (Non operating Shock Test, half-sinusoidal, 11ms, 15g)

EMC

Validated in Kontron reference housing for EMC the **COMe-cBT6** follows the requirements for electromagnetic compatibility standards

- » EN55022

3.9. MTBF

The following MTBF (Mean Time Before Failure) values were calculated using a combination of manufacturer's test data, if the data was available, and the Telcordia (Bellcore) issue 2 calculation for the remaining parts.

The calculation method used is "Telcordia Issue 2 Method 1 Case 3" in a ground benign, controlled environment (GB,GC). This particular method takes into account varying temperature and stress data and the system is assumed to have not been burned in. Other environmental stresses (extreme altitude, vibration, salt water exposure, etc) lower MTBF values.

MTBF (hours):

271,210@ 40C for 36015-0016-19-4 COMe-cBTi6 E3845 16GB

404,964@ 40C for 36017-0000-16-2 COMe-cBTc6 N2807

System MTBF (hours)



Fans usually shipped with Kontron products have 50,000-hour typical operating life. The above estimates assume no fan, but a passive heat sinking arrangement. Estimated RTC battery life (as opposed to battery failures) is not accounted for in the above figures and need to be considered separately. Battery life depends on both temperature and operating conditions. When the Kontron unit has external power; the only battery drain is from leakage paths.

3.10. Mechanical Specification

Dimension

» 95.0 mm x 95.0 mm (3.75" x 3.75")

» Height approx. 12mm (0.4")



CAD drawings are available at [EMD CustomerSection](#)

Height

The COM Express® specification defines a module height of 13mm from bottom to heatspreader top:

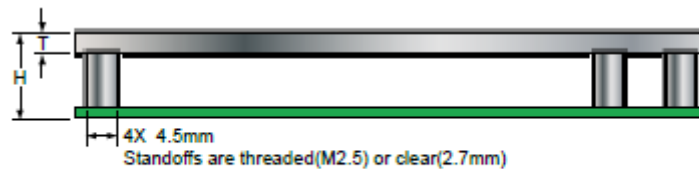

Thickness 'T' is implementation specific and may be 3mm.
Height 'H' (which includes PCB thickness) shall be 13.00mm

Cooling solutions provided from Kontron for compact sized Computer-on-Modules are 27mm in height from module bottom to Heatsink top. Universal Cooling solutions to be mounted on the HSP (36099-0000-00-x) are 14.3mm in height for an overall height of 27.3mm from module bottom to Heatsink top.

3.11. Module Dimensions

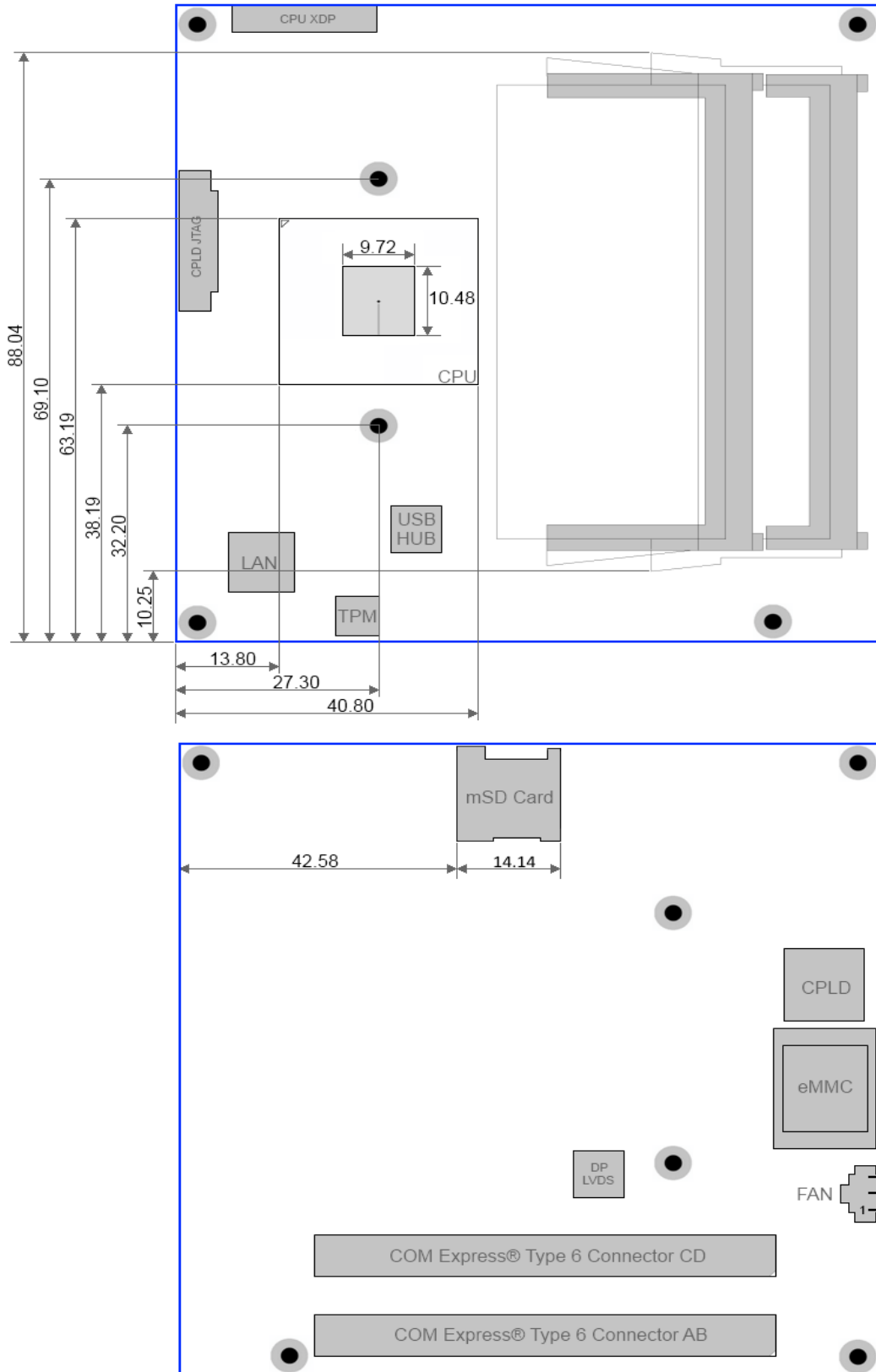

All

3.12. Onboard Fan Connector

Specification

- » Part number (Molex) J3: 53261-0371
- » Mates with: 51021-0300
- » Crimp terminals: 50079-8100

Pin assignment

- » Pin1: Tacho, Pin2: VCC, Pin3: GND

Electrical characteristic

Module Input Voltage	4.75 - 13V	>13
FAN Output Voltage	4.75 - 13V	13V
Max. FAN Output Current	350mA	150mA

3.13. Thermal Management, Heatspreader and Cooling Solutions

A heatspreader plate assembly is available from Kontron for the COMe-cBT6. The heatspreader plate on top of this assembly is NOT a heat sink. It works as a COM Express®-standard thermal interface to use with a heat sink or external cooling devices.

External cooling must be provided to maintain the heatspreader plate at proper operating temperatures. Under worst-case conditions, the cooling mechanism must maintain an ambient air and heatspreader plate temperature on any spot of the heatspreader's surface according to the module specifications:

- » 60°C for commercial grade modules
- » 75°C for extended temperature grade modules (E1)
- » 85°C for industrial temperature grade modules (E2/XT)

The aluminum slugs and thermal pads or the heat-pipe on the underside of the heatspreader assembly implement thermal interfaces between the heatspreader plate and the major heat-generating components on the COMe-cBT6. About 80 percent of the power dissipated within the module is conducted to the heatspreader plate and can be removed by the cooling solution.

You can use many thermal-management solutions with the heatspreader plates, including active and passive approaches. The optimum cooling solution varies, depending on the COM Express® application and environmental conditions. Active or passive cooling solutions provided from Kontron for the COMe-cBT6 are usually designed to cover the power and thermal dissipation for a commercial grade temperature range used in a housing with proper air flow.

Documentation and CAD drawings of COMe-cBT6 heatspreader and cooling solutions are provided at <http://emdcustomersection.kontron.com>.

4. Features and Interfaces

4.1. Onboard eMMC Flash

The COMe-cBT6 features a NAND Flash drive with capacities of 2-64GB eMMC.

The Flash drive supports

- » Compliant to JEDEC/eMMC standard version 4.4, 4.41, 4.5 & 5.0
- » 1 bit, 4 bits or 8 bits data bus width support
- » Data transfer rate up to 52Mbyte/s using 8 parallel data lines at 52MHz
- » Single data rate up to 200Mbyte/s @ HS200 mode with 200MHz Host clock
- » Dual data rate up to 104Mbyte/s @ 52MHz
- » Error free memory access (ECC and enhanced data management)
- » TRIM support
- » Multi-Level-Cell (MLC) technology
- » Single-Level-Cell (SLC) technology
- » Industrial temperature grade -45 to +85°C



Note: the onboard eMMC Flash requires pre-configuration via EFI Shell before OS installation (e.g. diskpart utility)

4.2. S5 Eco Mode

Kontron's new high-efficient power-off state S5 Eco enables lowest power-consumption in soft-off state – less than 1 mA compared to the regular S5 state this means a reduction by at least factor 200!

In the "normal" S5 mode the board is supplied by 5V_Stb and needs usually up to 300mA just to stay off. This mode allows to be switched on by power button, RTC event and WakeOnLan, even when it is not necessary. The new S5 Eco mode reduces the current enormous.

The S5 Eco Mode can be enabled in BIOS Setup, when the BIOS supports this feature.

Following prerequisites and consequences occur when S5 Eco Mode is enabled

- » The power button must be pressed at least for 200ms to switch on.
- » Wake via Power button only.
- » "Power On After Power Fail"/"State after G3": only "stay off" is possible

4.3. LPC

The Low Pin Count (LPC) Interface signals are connected to the LPC Bus bridge located in the CPU or chipset. The LPC low speed interface can be used for peripheral circuits such as an external Super I/O Controller, which typically combines legacy-device support into a single IC. The implementation of this subsystem complies with the COM Express® Specification. Implementation information is provided in the COM Express® Design Guide maintained by PICMG. Please refer to the official PICMG documentation for additional information.

The LPC bus does not support DMA (Direct Memory Access) and a clock buffer is required when more than one device is used on LPC. This leads to limitations for ISA bus and SIO (standard I/O 's like Floppy or LPT interfaces) implementations.

All Kontron COM Express® Computer-on-Modules imply BIOS support for following external baseboard LPC Super I/O controller features for the **Winbond/Nuvoton 5V 83627HF/G and 3.3V 83627DHG-P**:

83627HF/G	Phoenix BIOS	AMI CORE8	AMI / Phoenix EFI
PS/2	YES	YES	YES
COM1/COM2	YES	YES	YES
LPT	YES	YES	YES
HWM	YES	YES	NO
Floppy	NO	NO	NO
GPIO	NO	NO	NO
83627DHG-P	Phoenix BIOS	AMI CORE8	AMI / Phoenix EFI
PS/2	YES	YES	YES
COM1/COM2	YES	YES	YES
LPT	YES	YES	YES
HWM	NO	NO	NO
Floppy	NO	NO	NO
GPIO	NO	NO	NO

Features marked as not supported do not exclude OS support (e.g. HWM can be accessed via SMB). For any other LPC Super I/O additional BIOS implementations are necessary. Please contact your local sales or support for further details.

4.4. Serial Peripheral Interface (SPI)

The Serial Peripheral Interface Bus or SPI bus is a synchronous serial data link standard named by Motorola that operates in full duplex mode. Devices communicate in master/slave mode where the master device initiates the data frame. Multiple slave devices are allowed with individual slave select (chip select) lines. Sometimes SPI is called a “four wire” serial bus, contrasting with three, two, and one wire serial buses.



The SPI interface can only be used with a SPI flash device to boot from external BIOS on the baseboard.

4.5. SPI boot

The COMe-cBT6 supports boot from an external SPI Flash. It can be configured by pin A34 (BIOS_DIS#0) and pin B88 (BIOS_DIS1#) in following configuration:

BIOS_DIS0#	BIOS_DIS1#	Function
open	open	Boot on-module BIOS
GND	open	Boot baseboard LPC FWH
open	GND	Baseboard SPI = Boot Device 1, on-module SPI = Boot Device 2
GND	GND	Baseboard SPI = Boot Device 2, on-module SPI = Boot Device 1



By default only SPI Boot Device 1 is used in configuration 3 & 4. Both SPI Boot Devices are used by splitting the BIOS with modified descriptor table in customized versions only

Recommended SPI boot flash types for 8-SOIC package

Size	Manufacturer	Part Number	Device ID
16Mbit	Atmel	AT26DF161	0x1F4600
16Mbit	Atmel	AT26DF161A	0x1F4601
16Mbit	Atmel	AT25DF161	0x1F4602
16Mbit	Atmel	AT25DQ161	0x1F8600
16Mbit	Macronix	MX25L1605A(D)(36E)(06E)	0xC22015
16Mbit	Macronix	MX25L1635D	0xC22415
16Mbit	SST/Microchip	SST25VF016B	0xBF2541
16Mbit	Winbond	W25X16BV	0xEF3015
16Mbit	Winbond	W25Q16BV(CV)	0xEF4015
Size	Manufacturer	Part Number	Device ID
32Mbit	Atmel	AT25/26DF321	0x1F4700
32Mbit	Atmel	AT25DF321A	0x1F4701
32Mbit	Macronix	MX25L3205A(D)(06E)	0xC22016
32Mbit	Macronix	MX25L3225D(35D)(36D)	0xC25E16
32Mbit	SST/Microchip	SST25VF032B	0xBF254A
32Mbit	Winbond	W25X32BV	0xEF3016
32Mbit	Winbond	W25Q32BV,	0xEF4016
Size	Manufacturer	Part Number	Device ID
64Mbit	Atmel	AT25DF641(A)	0x1F4800
64Mbit	Atmel	AT25DQ641	0x1F8800
64Mbit	Macronix	MX25L6405D(45E)(36E)(06E)(73E)	0xC22017
64Mbit	Macronix	MX25L6455E	0xC22617
64Mbit	Macronix	MX25U6435F	0xC22537
64Mbit	SST/Microchip	SST25VF064C	0xBF254B
64Mbit	Winbond	W25X64BV	0xEF3017
64Mbit	Winbond	W25Q64BV(CV)(FV)	0xEF4017
64Mbit	Winbond	W25Q64DW	0XEF6017
64Mbit	Winbond	W25Q64FW	0XEF6017

Using an external SPI flash

To program an external SPI flash follow these steps:

- » Connect a SPI flash with correct size (similar to BIOS ROM file size) to the module SPI interface
- » Open pin A34 and B88 to boot from the module BIOS
- » Boot the module to DOS/EFI-Shell with access to the BIOS image and Firmware Update Utility provided on EMD Customer Section
- » Connect pin B88 (BIOS_DIS1#) to ground to enable the external SPI flash
- » Execute Flash.bat/Flash.efi to program the complete BIOS image to the external SPI flash
- » reboot

Your module will now boot from the external SPI flash when BIOS_DIS1# is grounded.

External SPI flash on Modules with Intel® ME

If booting from the external (baseboard mounted) SPI flash then exchanging the COM Express® module for another one of the same type will cause the Intel® Management Engine to fail during next start. This is by design of the ME because it bounds itself to the very module it has been flashed to. In the case of an external SPI flash this is the module present at flash time.

To avoid this issue please make sure to conduct a complete flash of the external SPI flash device after changing the COMexpress module for another one. If disconnecting and reconnecting the same module again this step is not necessary.

4.6. M.A.R.S.

The Smart Battery implementation for Kontron Computer-on-Modules called **Mobile Application for Rechargeable Systems** is a BIOS extension for external Smart Battery Manager or Charger. It includes support for SMBus charger/selector (e.g. Linear Technology LTC1760 Dual Smart Battery System Manager) and provides ACPI compatibility to report battery information to the Operating System.

Reserved SM-Bus addresses for Smart Battery Solutions on the carrier:

8-bit Address	7-bit Address	Device
12h	0x09	SMART_CHARGER
14h	0x0A	SMART_SELECTOR
16h	0x0B	SMART_BATTERY

4.7. UART

The COMe-cBT6 supports up to two Serial RX/TX only Ports defined in COM Express® specification on Pins A98/A99 for UART0 and Pins A101/A102 for UART1. The implementation of the UART is compatible to 16450 and is supported by default from most operating systems. Resources are subordinated to other UARTS e.g. from external LPC Super I/O.

UART features:

- » 450 to 115.2k Baud (except 56000)
- » 5, 6, 7 or 8bit characters
- » 1 or 2 Stop bit generation
- » Even, odd or no-parity generation/detection
- » Complete status reporting capabilities
- » Line break generation and detection
- » Full prioritized interrupt system control
- » No FIFO
- » One additional shift register for transmit and one for receive
- » No Flow Control
- » No FCR register due to unavailability of FIFO
- » MCR and MSR registers only implemented in loopback mode for compatibility with existing drivers and APIs
- » Initialized per default to COM3 3F8h/IRQ4 and COM4 2F8/IRQ3 without external SIO
- » Initialized per default to COM3 3E8h/IRQ5 and COM4 2E8/IRQ10 with external SIO present

The UART clock is generated by the 33MHz LPC clock which results in an accuracy of 0.5% on all UART timings



- Due to the protection circuitry required according COM Express® specification the transfer speed can only be guaranteed for 9600 Baud. Please contact your local sales or support for customized versions without protection circuitry

- Legacy console redirection via onboard serial ports may be restricted in terms of serial input stream. Since they're only emulating a 16450 device (w/o FIFO) an input stream generated by a program may lose characters. Inputs from a keyboard via terminal program will be safe.

4.8. Fast I2C

The COMe-cBT6 supports a CPLD implemented LPC to I2C bridge using the WISHBONE I2C Master Core provided from opencores.org. The I2C Interface supports transfer rates up to 40kB/s and can be configured in Setup

Specification for external I2C:

- » Speed up to 400kHz
- » Compatible to Philips I2C bus standard
- » Multi-Master capable
- » Clock stretching support and wait state generation
- » Interrupt or bit-polling driven byte-by-byte data-transfers
- » Arbitration lost interrupt with automatic transfer cancellation
- » Start/Stop signal generation/detection
- » Bus busy detection
- » 7bit and 10bit addressing

4.9. Dual Staged Watchdog Timer

4.9.1.1. Basics

A watchdog timer (or computer operating properly (COP) timer) is a computer hardware or software timer that triggers a system reset or other corrective action if the main program, due to some fault condition, such as a hang, neglects to regularly service the watchdog (writing a “service pulse” to it, also referred to as “kicking the dog”, “petting the dog”, “feeding the watchdog” or “triggering the watchdog”). The intention is to bring the system back from the nonresponsive state into normal operation.

The COMe-cBT6 offers a watchdog which works with two stages that can be programmed independently and used one by one.

4.9.1.2. Time-out events

Reset	A reset will restart the module and starts POST and operating system new.
NMI	A non-maskable interrupt (NMI) is a computer processor interrupt that cannot be ignored by standard interrupt masking techniques in the system. It is typically used to signal attention for non-recoverable hardware errors.
SCI	A system control interrupt (SCI) is a OS-visible interrupt to be handled by the OS using AML code
Delay	Might be necessary when an operating system must be started and the time for the first trigger pulse must extended. (Only available in the first stage)
WDT Signal only	This setting triggers the WDT Pin on baseboard connector (COM Express® Pin B27) only
Cascade:	Does nothing, but enables the 2nd stage after the entered time-out.

4.9.1.3. WDT Signal

B27 on COM Express® Connector offers a signal that can be asserted when a watchdog timer has not been triggered within time. It can be configured to any of the 2 stages. Deassertion of the signal is automatically done after reset. If deassertion during runtime is necessary please ask your Kontron technical support for further help.

4.10. Speedstep Technology

The Intel® processors offer the Intel® Enhanced SpeedStep™ technology that automatically switches between maximum performance mode and battery-optimized mode, depending on the needs of the application being run. It enables you to adapt high performance computing on your applications. When powered by a battery or running in idle mode, the processor drops to lower frequencies (by changing the CPU ratios) and voltage, conserving battery life while maintaining a high level of performance. The frequency is set back automatically to the high frequency, allowing you to customize performance.

In order to use the Intel® Enhanced SpeedStep™ technology the operating system must support SpeedStep™ technology.

By deactivating the SpeedStep feature in the BIOS, manual control/modification of CPU performance is possible. Setup the CPU Performance State in the BIOS Setup or use 3rd party software to control CPU Performance States.

4.11. C-States

New generation platforms include power saving features like SuperLFM, EIST (P-States) or C-States in O/S idle mode.

Activated C-States are able to dramatically decrease power consumption in idle mode by reducing the Core Voltage or switching of parts of the CPU Core, the Core Clocks or the CPU Cache.

Following C-States are defined:

C-State	Description	Function
C0	Operating	CPU fully turned on
C1	Halt State	Stops CPU main internal clocks via software
C1E	Enhanced Halt	Similar to C1, additionally reduces CPU voltage
C2	Stop Grant	Stops CPU internal and external clocks via hardware
C2E	Extended Stop Grant	Similar to C2, additionally reduces CPU voltage
C3	Deep Sleep	Stops all CPU internal and external clocks
C3E	Extended Stop Grant	Similar to C3, additionally reduces CPU voltage
C4	Deeper Sleep	Reduces CPU voltage
C4E	Enhanced Deeper Sleep	Reduces CPU voltage even more and turns off the memory cache
C6	Deep Power Down	Reduces the CPU internal voltage to any value, including 0V
C7	Deep Power Down	Similar to C6, additionally LLC (LastLevelCache) is switched off

C-States are usually enabled by default for low power consumption, but active C-States may influence performance sensitive applications or real-time systems.

- » Active C6-State may influence data transfer on external Serial Ports
- » Active C7-State may cause lower CPU and Graphics performance

It's recommended to disable C-States / Enhanced C-States in BIOS Setup if any problems occur.

4.12. Graphics Features

The integrated Intel® HD Graphics (Gen 7) graphics supports following OS dependent featureset:

O/S	Win8 / WES8	Win7 / WES7	WEC7	Linux (F18/Yocto1.6)	Linux (Tizen IVI 32b)	Android 4.2/4.4
DisplayPort	DP 1.1a up to 2560×1600					not supported
HDMI (via external LS)	HDMI 1.4a up to 1920×1200					
VGA (COMe-compact only)	up to 2560×1600					not supported
eDP	eDP 1.3 up to 2560×1600 or LVDS up to 1920×1080 via eDP-LVDS Bridge					
Dual Independent Display	Yes					
2D HW acceleration	DirectDraw			X Server	Wayland Compositor	OpenGL Renderer
3D HW acceleration	OGL4.0, DX11.1/10/9		OGLES 2.0	OGL3.2/OGLES2.0		OGLES 1.1/2.0 in 4.2 OGLES 1.1/2.0/3.0 in 4.4 KitKat
HW Media Acceleration	DXVA 2		DirectShow	VAAPI	OGL3.2/OGLES2.0	OpenMax
HW Video Decode	H.264,MPEG2,VC1,VP8		H.264,MPEG2,VC1	H.264,MPEG2,VC1,VP8	H.264,MPEG2,VC1,VP8	H.264,H.263,VC1,WMV9,VP8,MPEG4 in 4.2 H.264, VC1 in 4.4
HW Video Encode	H.264,MPEG2		not supported	H.264,MPEG2	H.264,MPEG2	H.264
Blu-Ray	v2.0					not supported
Media players	Windows Media Player PowerDVD		CEPlayer	GStreamer - VAAPI		Gallery, Widevine
Content Protection*	PAVP	HDCP	not supported			Widevine L1

* Supported with active TXE Engine only (available with custom BIOS only)

4.13. ACPI Suspend Modes and Resume Events

The COMe-cBT6 supports the S-states S0, S3, S4, S5. S5eco Support: YES

The following events resume the system from S3:

- » USB Keyboard (1)
- » USB Mouse (1)
- » Power Button
- » WakeOnLan (2)

The following events resume the system from S4:

- » Power Button
- » WakeOnLan (2)

The following events resume the system from S5:

- » Power Button
- » WakeOnLan (2)

The following events resume the system from S5Eco:

- » Power Button



- (1) OS must support wake up via USB devices and baseboard must power the USB Port with StBy-Voltage
- (2) Depending on the Used Ethernet MAC/Phy WakeOnLan must be enabled in BIOS setup and driver options

4.14. USB

The COMe-cBT6 supports up to 8x USB 2.0/1x USB 3.0 with following internal EHCI/xHCI configuration:

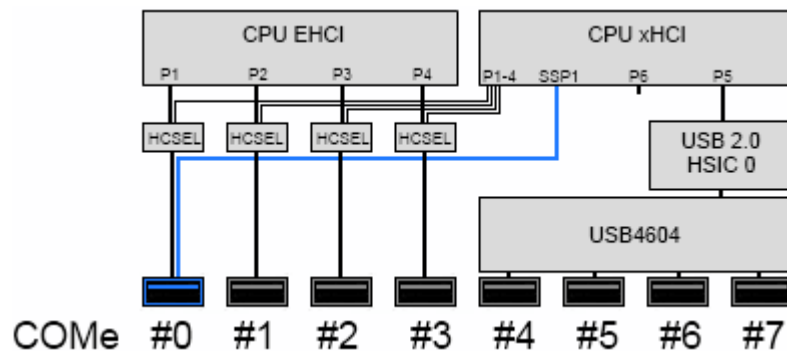

Note: The USB Ports provided by the HSIC USB Hub requires xHCI enabled in Setup and full USB 3.0 OS Support

5. System Resources

5.1. Interrupt Request (IRQ) Lines

IRQ #	Used For
0	Timer0
1	Keyboard
2	Redirected secondary PIC
3	Onboard - COM2
4	Onboard - COM1
5	SIO COM3 or 4
6	SIO COM3 or 4
7	SIO LPT or COM3/4
8	RTC
9	Free for PCI devices
10	Free for PCI devices
11	Free for PCI devices
12	PS/2 mouse or free for PCI devices
13	FPU
14	not used
15	not used

5.2. Memory Area

Address range (hex)	Size	Usage
00000000-0009FFFF	640 KB	DOS- (Real mode-) memory
000A0000-000BFFFF	128 KB	Display memory
000C0000-000CBFFF	48 KB	VGA BIOS
000CC000-000DFFFF	80 KB	Option ROM or XMS
000E0000-000EFFFF	64 KB	System BIOS extended space
000F0000-000FFFFF	64 KB	System BIOS base segment
0x20000000-00100000-7FFFFFFF	2 GB - 1 MB	System memory (Low DRAM)
0x20000000-0x20001000	4KB	Minimum mapping for chipset LPE device
80000000-FFF00000	2 GB - 1 MB	PCI memory, other extensions (Low MMIO)
FEC00000-FEC00040	64 Bytes	IOxAPIC
FED00000-FED003FF	1 KB	HPET (Timer)
FED1C000-FED1CFFF	4KB	Chipset internal register space
FED40000-FED4B000	44 KB	TPM hard coded memory
FFFF0000-FFFFFFFF	64 KB	Mapping space for BIOS ROM/Boot vector
100000000-17FFFFFFF	2 GB	System memory (High DRAM)
180000000-F00000000	58 GB	High MMIO

5.3. I/O Address Map

The I/O-port addresses of the are functionally identical to a standard PC/AT. All addresses not mentioned in this table should be available. We recommend that you do not use I/O addresses below 0100h with additional hardware for compatibility reasons, even if available.

I/O Address	Usage
0000-000F	DMA-Controller Master (8237)
0020-0021 024-025 028-029 02C-02D 030-031 034-035 038-039 03C-03D	Interrupt-Controller Master (8259)
002E-002F	External SuperI/O
040-043 050-053	Programmable Interrupt Timer (8253)
04E-04F	TPM
060, 064	KBD Interface-Controller (8042)
061, 063, 065, 067	NMI Controller
070-071	RTC CMOS / NMI mask
072-073	RTC Extended CMOS
080-083	Debug port
0A0-0A1 0A4-0A5 0A8-0A9 0AC-0AD 0B0-0B1 0B4-0B5 0B8-0B9 0BC-0BD	Interrupt-Controller Slave (8259)
0B2-0B3	APM control
279	ISA PnP
295-296	External Hardware monitor, optionally used by external SuperIO if present
2E8-2EF	Serial port COM4 (SIO COM2)
2F8-2FF	Serial port COM2 (onboard COM2)
370-377	Floppy disk controller, optionally used by external SuperIO if present (370h to 371h)
378-37F	Parallel port LPT 1, optionally used by external SuperIO if present
3C0-3CF	VGA/EGA
3E8-3EF	Serial port COM3 (SIO COM1)
3F8-3FF	Serial Port COM1 (onboard COM1)
400-4FF	Chipset internal register I/O area
4D0-4D1	Interrupt-Controller (Slave)
500-5FF	Chipset internal register I/O area
A80-A81	Kontron CPLD control port
CF8	PCI configuration address
CF9	Reset control
CFC-CFF	PCI configuration data

5.4. Peripheral Component Interconnect (PCI) Devices

All devices follow the Peripheral Component Interconnect 2.3 (PCI 2.3) respectively the PCI Express Base 1.0a specification. The BIOS and OS control memory and I/O resources. Please see the PCI 2.3 specification for details.

Device	Bus/Device/Function	VID/DID default	Comment
Transaction Router (former host bridge)	0/0/0	8086h/0F00h	-
Graphics & display	0/2/0	8086h/0F31h	-
Camera image signal processor	0/3/0	8086h/0F38h	Not used
eMMC	0/16/0	8086h/0F14h	-
SDIO	0/17/0	8086h/0F15h	Not used
SD	0/18/0	8086h/0F16h	-
SATA	0/19/0	8086h/0F23h	-
xHCI	0/20/0	8086h/8C31h	-
Low-power Audio	0/21/0	8086h/0F28h	-
I2S port 0	0/21/1	-	-
I2S port 1	0/21/2	-	-
I2S port 2	0/21/3	-	-
USB3.0 device	0/22/0	8086h	-
SIO I2C DMA Configuration	0/24/0	8086h/0F40h	-
I2C1 Configuration	0/24/1	8086h/0F41h	-
I2C2 Configuration	0/24/2	8086h/0F42h	-
I2C3 Configuration	0/24/3	8086h/0F43h	-
I2C4 Configuration	0/24/4	8086h/0F44h	-
I2C5 Configuration	0/24/5	8086h/0F45h	-
I2C6 Configuration	0/24/6	8086h/0F46h	-
I2C7 Configuration	0/24/7	8086h/0F47h	-
Trusted Execution engine	0/26/0	8086h/0F18h	-
HD Audio	0/27/0	8086h/0F04h	-
PCIExpress Root port 0	0/28/0	8086h	-
PCIExpress Root port 1	0/28/1	-	-
PCIExpress Root port 2	0/28/2	-	-
PCIExpress Root port 3	0/28/3	-	-
EHCI	0/29/0	8086h/0F34h	-
SerialIO HSUART / PWM / SPI DMA	0/30/0	8086h/0F06h	-
PWM Port 1	0/30/1	8086h	-
PWM Port 2	0/30/2	8086h	-
HSUART1	0/30/3	8086h/0F0Ah	-
HSUART2	0/30/4	8086h/0F0Ch	-
SPI	0/30/5	8086h/0F0Eh	-
PCU LPC	0/31/0	8086h/0F1Ch	-

5.5. LPC addresses

I/O address	Device
2Eh/2Fh	external SuperI/O Winbond/Nuvoton 83627
4Eh/4Fh	TPM
0A80h/0A81h	CPLD

5.6. I2C Bus

8-bit Address	7-bit Address	Device	Bus
58h	0x2C	S5eco resistor	internal
5Ah	0x2D	USB HSIC Hub	internal
COh	0x60	DP2LVDS bridge	internal
A0h	0x50	LVDS EEPROM	internal
A0h	0x50	Module / JIDA EEPROM	external
AEh	0x57	Carrier EEPROM	external

5.7. System Management (SM) Bus

8-bit Address	7-bit Address	Device	Bus
10h	0x08	HSIC	internal
30h	0x18	DDR3L 0 Thermal sensor option	internal
32h	0x19	DDR3L 1 Thermal sensor option	internal
5Ah	0x2D	onboard HWMonitor	internal
A0h	0x50	DDR3L SPD 0	internal
A2h	0x51	DDR3L SPD 1	internal
C8h	0x64	Ethernet	internal
12h	0x09	SMART_CHARGER	external
14h	0x0A	SMART_SELECTOR	external
16h	0x0B	SMART_BATTERY	external
58h	0x2C	SIO HWMonitor	external



Do not use any reserved addresses mentioned above for other devices

6. Pinout List

6.1. General Signal Description

Type	Description
I/O-3,3	Bi-directional 3,3 V I/O-Signal
I/O-5T	Bi-dir. 3,3V I/O (5V Tolerance)
I/O-5	Bi-directional 5V I/O-Signal
I-3,3	3,3V Input
I/OD	Bi-directional Input/Output Open Drain
I-5T	3,3V Input (5V Tolerance)
OA	Output Analog
OD	Output Open Drain
O-1,8	1,8V Output
O-3,3	3,3V Output
O-5	5V Output
DP-I/O	Differential Pair Input/Output
DP-I	Differential Pair Input
DP-O	Differential Pair Output
PU	Pull-Up Resistor
PD	Pull-Down Resistor
PWR	Power Connection



To protect external power lines of peripheral devices, make sure that: the wires have the right diameter to withstand the maximum available current the enclosure of the peripheral device fulfills the fire-protection requirements of IEC/EN60950

6.2. Connector X1A Row A

Pin	Signal	Description	Type	Termination	Comment
A1	GND	Power Ground	PWR GND	-	-
A2	GBEO_MDI3-	Ethernet Media Dependent Interface 3 -	DP-I/O	-	-
A3	GBEO_MDI3+	Ethernet Media Dependent Interface 3 +	DP-I/O	-	-
A4	GBEO_LINK100#	Ethernet Speed LED	OD	-	-
A5	GBEO_LINK1000#	Ethernet Speed LED	OD	-	-
A6	GBEO_MDI2-	Ethernet Media Dependent Interface 2 -	DP-I/O	-	-
A7	GBEO_MDI2+	Ethernet Media Dependent Interface 2 +	DP-I/O	-	-
A8	GBEO_LINK#	LAN Link LED	OD	-	-
A9	GBEO_MDI1-	Ethernet Media Dependent Interface 1 -	DP-I/O	-	-
A10	GBEO_MDI1+	Ethernet Media Dependent Interface 1 +	DP-I/O	-	-
A11	GND	Power Ground	PWR GND	-	-
A12	GBEO_MDI0-	Ethernet Media Dependent Interface 0 -	DP-I/O	-	-
A13	GBEO_MDI0+	Ethernet Media Dependent Interface 0 +	DP-I/O	-	-
A14	GBEO_CTREF	Center Tab Reference Voltage	0	-	100nF capacitor to GND
A15	SUS_S3#	Suspend To RAM (or deeper) Indicator	0-3.3	PD 10k	-
A16	SATA0_TX+	SATA Transmit Pair 0 +	DP-0	-	-
A17	SATA0_TX-	SATA Transmit Pair 0 -	DP-0	-	-
A18	SUS_S4#	Suspend To Disk (or deeper) Indicator	0-3.3	-	-
A19	SATA0_RX+	SATA Receive Pair 0 +	DP-I	-	-
A20	SATA0_RX-	SATA Receive Pair 0 -	DP-I	-	-
A21	GND	Power Ground	PWR GND	-	-
A22	SATA2_TX+	USB 3.0 Receive Pair 0 -	DP-I	-	-
A23	SATA2_TX-	USB 3.0 Receive Pair 0 +	DP-I	-	-
A24	SUS_S5#	Soft Off Indicator	0-3.3	-	-
A25	SATA2_RX+	USB 3.0 Receive Pair 1 -	DP-I	-	-
A26	SATA2_RX-	USB 3.0 Receive Pair 1 +	DP-I	-	-
A27	BATLOW#	Battery Low	I-3.3	PU 10k 3.3V (S5)	assertion will prevent wake from S3-S5 state
A28	ATA_ACT#	Serial ATA activity LED	OD-3.3	PU 10k 3.3V (S0)	can sink 15mA
A29	HDA_SYNC	HD Audio Sync	0-3.3	PD 20k in CPU	-
A30	HDA_RST#	HD Audio Reset	0-3.3	PD 20k in CPU	-
A31	GND	Power Ground	PWR GND	-	-
A32	HDA_CLK	HD Audio Bit Clock Output	0-3.3	PD 20k in CPU	-
A33	HDA_SDOUT	HD Audio Serial Data Out	0-3.3	PD 20k in CPU	-
A34	BIOS_DIS0#	BIOS Selection Strap 0	I-3.3	PU 10k 3.3V (S0)	-
A35	THRMTRIP#	Thermal Trip	0-3.3	PU 10k 3.3V (S0)	do not use as this signal does not differ between regular and over-temperature shutdown
A36	USB6-	USB 2.0 Data Pair Port 6 -	DP-I/O	PD/PU in CPU	PD 15k0hm +/-5% on Downstream Facing Port; PU 1.5k0hm +/-5% on Upstream Facing Port
A37	USB6+	USB 2.0 Data Pair Port 6 +	DP-I/O	PD/PU in CPU	PD 15k0hm +/-5% on Downstream Facing Port; PU 1.5k0hm +/-5% on Upstream Facing Port
A38	USB_6_7_OC#	USB Overcurrent Indicator Port 6/7	I-3.3	PU 10k 3.3V (S5)	-
A39	USB4-	USB 2.0 Data Pair Port 4 -	DP-I/O	PD/PU in CPU	PD 15k0hm +/-5% on Downstream Facing Port; PU 1.5k0hm +/-5% on Upstream Facing Port
A40	USB4+	USB 2.0 Data Pair Port 4 +	DP-I/O	PD/PU in CPU	PD 15k0hm +/-5% on Downstream Facing Port; PU 1.5k0hm +/-5% on Upstream Facing Port
A41	GND	Power Ground	PWR GND	-	-
A42	USB2-	USB 2.0 Data Pair Port 2 -	DP-I/O	PD/PU in CPU	PD 15k0hm +/-5% on Downstream Facing Port; PU 1.5k0hm +/-5% on Upstream Facing Port
A43	USB2+	USB 2.0 Data Pair Port 2 +	DP-I/O	PD/PU in CPU	PD 15k0hm +/-5% on Downstream Facing Port; PU 1.5k0hm +/-5% on Upstream Facing Port
A44	USB_2_3_OC#	USB Overcurrent Indicator Port 2/3	I-3.3	PU 15k in CPLD (S5)	resistor value can range from 5k0hm to 25k0hm
A45	USB0-	USB 2.0 Data Pair Port 0 -	DP-I/O	PD/PU in CPU	PD 15k0hm +/-5% on Downstream Facing Port; PU 1.5k0hm +/-5% on Upstream Facing Port
A46	USB0+	USB 2.0 Data Pair Port 0 +	DP-I/O	PD/PU in CPU	PD 15k0hm +/-5% on Downstream Facing Port; PU 1.5k0hm +/-5% on Upstream Facing Port
A47	VCC_RTC	Real-Time Clock Circuit Power Input	PWR 3V	-	voltage range 2.8-3.47V
A48	EXCDO_PERST#	Express Card Reset Port 0	0-3.3	-	-
A49	EXCDO_CPPE#	Express Card Capable Card Request Port 0	I-3.3	PU 10k 3.3V (S0)	-
A50	LPC_SERIRQ	Serial Interrupt Request	I/OD-3.3	PU 20k in CPU	-
A51	GND	Power Ground	PWR GND	-	-
A52	PCIE_TX5+	Not Connected	nc	-	-
A53	PCIE_TX5-	Not Connected	nc	-	-
A54	GPIO	General Purpose Input 0	I-3.3	PU 100k 3.3V (S0)	-
A55	PCIE_TX4+	Not Connected	nc	-	-
A56	PCIE_TX4-	Not Connected	nc	-	-
A57	GND	Power Ground	PWR GND	-	-

A58	PCIE_TX3+	PCI Express Lane 3 Transmit +	DP-0	-	only available on no-LAN var.
A59	PCIE_TX3-	PCI Express Lane 3 Transmit -	DP-0	-	only available on no-LAN var.
A60	GND	Power Ground	PWR GND	-	-
A61	PCIE_TX2+	PCI Express Lane 2 Transmit +	DP-0	-	-
A62	PCIE_TX2-	PCI Express Lane 2 Transmit -	DP-0	-	-
A63	GPI1	General Purpose Input 1	I-3.3	PU 100k 3.3V (S0)	-
A64	PCIE_TX1+	PCI Express Lane 1 Transmit +	DP-0	-	-
A65	PCIE_TX1-	PCI Express Lane 1 Transmit -	DP-0	-	-
A66	GND	Power Ground	PWR GND	-	-
A67	GPI2	General Purpose Input 2	I-3.3	PU 100k 3.3V (S0)	-
A68	PCIE_TX0+	PCI Express Lane 0 Transmit +	DP-0	-	-
A69	PCIE_TX0-	PCI Express Lane 0 Transmit -	DP-0	-	-
A70	GND	Power Ground	PWR GND	-	-
A71	LVDS_A0+	LVDS Channel A DAT0+	DP-0	-	-
A72	LVDS_A0-	LVDS Channel A DAT0-	DP-0	-	-
A73	LVDS_A1+	LVDS Channel A DAT1+	DP-0	-	-
A74	LVDS_A1-	LVDS Channel A DAT1-	DP-0	-	-
A75	LVDS_A2+	LVDS Channel A DAT2+	DP-0	-	-
A76	LVDS_A2-	LVDS Channel A DAT2-	DP-0	-	-
A77	LVDS_VDD_EN	LVDS Panel Power Control	O-3.3	PD 100k	-
A78	LVDS_A3+	LVDS Channel A DAT3+	DP-0	-	-
A79	LVDS_A3-	LVDS Channel A DAT3-	DP-0	-	-
A80	GND	Power Ground	PWR GND	-	-
A81	LVDS_A_CK+	LVDS Channel A Clock+	DP-0	-	20-80MHz
A82	LVDS_A_CK-	LVDS Channel A Clock-	DP-0	-	20-80MHz
A83	LVDS_I2C_CK	LVDS I2C Clock (DDC)	IO-3.3	PU 2k21 3.3V (S0)	-
A84	LVDS_I2C_DAT	LVDS I2C Data (DDC)	IO-3.3	PU 2k21 3.3V (S0)	-
A85	GPI3	General Purpose Input 3	I/O-3.3	PU 100k 3.3V (S0)	-
A86	RSVD	Reserved for future use	nc	-	-
A87	RSVD	Reserved for future use	nc	-	-
A88	PCIE0_CK_REF+	Reference PCI Express Clock +	DP-0	-	100MHz
A89	PCIE0_CK_REF-	Reference PCI Express Clock -	DP-0	-	100MHz
A90	GND	Power Ground	PWR GND	-	-
A91	SPI_POWER	3.3V Power Output Pin for external SPI flash	O-3.3	-	100mA (max.)
A92	SPI_MISO	SPI Master IN Slave OUT	I-3.3	PD 20k in CPU (SPI)	All SPI signals are tri-stated with 20k ohm CPU internal weak pull-up until reset is deasserted
A93	GPO0	General Purpose Output 0	O-3.3	PD 100k	-
A94	SPI_CLK	SPI Clock	O-3.3	PD 20k in CPU (SPI)	All SPI signals are tri-stated with 20k ohm CPU internal weak pull-up until reset is deasserted
A95	SPI_MOSI	SPI Master Out Slave In	O-3.3	PD 20k in CPU (SPI)	All SPI signals are tri-stated with 20k ohm CPU internal weak pull-up until reset is deasserted
A96	TPM_PP	TPM Physical Presence	nc	-	TPM_PP not supported by used TPM
A97	TYPE10#	Indicates TYPE10# to carrier board	nc	-	-
A98	SERO_TX	Serial Port 0 TXD	O-3.3	-	20V protection circuit implemented on module, PD on carrier board needed for proper operation
A99	SERO_RX	Serial Port 0 RXD	I-5T	PU 47k 3.3V (S0)	20V protection circuit implemented on module
A100	GND	Power Ground	PWR GND	-	-
A101	SER1_TX	Serial Port 1 TXD	O-3.3	-	20V protection circuit implemented on module, PD on carrier board needed for proper operation
A102	SER1_RX	Serial Port 1 RXD	I-5T	PU 47k 3.3V (S0)	20V protection circuit implemented on module
A103	LID#	LID Switch Input	I-3.3	PU 47k 3.3V (S5)	20V protection circuit implemented on module
A104	VCC_12V	Main Input Voltage (8.5-20V)	PWR 8.5-20V	-	-
A105	VCC_12V	Main Input Voltage (8.5-20V)	PWR 8.5-20V	-	-
A106	VCC_12V	Main Input Voltage (8.5-20V)	PWR 8.5-20V	-	-
A107	VCC_12V	Main Input Voltage (8.5-20V)	PWR 8.5-20V	-	-
A108	VCC_12V	Main Input Voltage (8.5-20V)	PWR 8.5-20V	-	-
A109	VCC_12V	Main Input Voltage (8.5-20V)	PWR 8.5-20V	-	-
A110	GND	Power Ground	PWR GND	-	-

6.3. Connector X1A Row B

Pin	Signal	Description	Type	Termination	Comment
B1	GND	Power Ground	PWR GND	-	-
B2	GBEO_ACT#	Ethernet Activity LED	OD	-	-
B3	LPC_FRAME#	LPC Frame Indicator	0-3.3	PU 20k in CPU (S0)	-
B4	LPC_ADO	LPC Multiplexed Command, Address & Data 0	I/O-3.3	PU 20k in CPU (S0)	-
B5	LPC_AD1	LPC Multiplexed Command, Address & Data 1	I/O-3.3	PU 20k in CPU (S0)	-
B6	LPC_AD2	LPC Multiplexed Command, Address & Data 2	I/O-3.3	PU 20k in CPU (S0)	-
B7	LPC_AD3	LPC Multiplexed Command, Address & Data 3	I/O-3.3	PU 20k in CPU (S0)	-
B8	LPC_DRQ0#	LPC Serial DMA/Master Request 0	I-3.3	PU 15k in CPLD (S5)	resistor value can range from 5k0hm to 25k0hm
B9	LPC_DRQ1#	LPC Serial DMA/Master Request 1	I-3.3	PU 15k in CPLD (S5)	resistor value can range from 5k0hm to 25k0hm
B10	LPC_CLK	33MHz LPC clock	0-3.3	PD 20k in CPU	33MHz at E38xx CPUs and 25MHz at other CPUs
B11	GND	Power Ground	PWR GND	-	-
B12	PWRBTN#	Power Button	I-3.3	PU 10k 3.3V (S5eco)	-
B13	SMB_CLK	SMBUS Clock	0-3.3	PU 2k9 3.3V (S5)	-
B14	SMB_DAT	SMBUS Data	I/O-3.3	PU 2k9 3.3V (S5)	-
B15	SMB_ALERT#	SMBUS Alert	I/O-3.3	PU 10k 3.3V (S5)	-
B16	SATA1_TX+	SATA 1 Transmit Pair +	DP-0	-	-
B17	SATA1_TX-	SATA 1 Transmit Pair -	DP-0	-	-
B18	SUS_STAT#	Suspend Status	0-3.3	-	-
B19	SATA1_RX+	SATA 1 Receive Pair +	DP-I	-	-
B20	SATA1_RX-	SATA 1 Receive Pair -	DP-I	-	-
B21	GND	Power Ground	PWR GND	-	-
B22	SATA3_TX+	Not Connected	nc	-	-
B23	SATA3_TX-	Not Connected	nc	-	-
B24	PWR_OK	Power OK	I-5T	PU 61k 3.3V	pullup voltage is S0 in ATX mode/ S5 in single supply mode / 5V tolerant
B25	SATA3_RX+	Not Connected	nc	-	-
B26	SATA3_RX-	Not Connected	nc	-	-
B27	WDT	Watch Dog Time-Out event	0-3.3	-	-
B28	HDA_SDIN2	Not Connected	nc	-	not supported
B29	HDA_SDIN1	Audio Codec Serial Data in 1	I-3.3	PD 20k in CPU	-
B30	HDA_SDINO	Audio Codec Serial Data in 0	I-3.3	PD 20k in CPU	-
B31	GND	Power Ground	PWR GND	-	-
B32	SPKR	Speaker	0-3.3	PU 20k in CPU (S0)	-
B33	I2C_CLK	I2C Clock	0-3.3	PU 2k21 3.3V (S5)	-
B34	I2C_DAT	I2C Data	I/O-3.3	PU 2k21 3.3V (S5)	-
B35	THRM#	Over Temperature Input	I-3.3	PU 10k 3.3V (S0)	no function implemented
B36	USB7-	USB 2.0 Data Pair Port 7 -	DP-I/O	PD/PU in CPU	PD 15k0hm +/-5% on Downstream Facing Port; PU 1.5k0hm +/-5% on Upstream Facing Port
B37	USB7+	USB 2.0 Data Pair Port 7 +	DP-I/O	PD/PU in CPU	PD 15k0hm +/-5% on Downstream Facing Port; PU 1.5k0hm +/-5% on Upstream Facing Port
B38	USB_4_5_OC#	USB Overcurrent Indicator Port 4/5	I-3.3	PU 10k 3.3V (S5)	-
B39	USB5-	USB 2.0 Data Pair Port 5 -	DP-I/O	PD/PU in CPU	PD 15k0hm +/-5% on Downstream Facing Port; PU 1.5k0hm +/-5% on Upstream Facing Port
B40	USB5+	USB 2.0 Data Pair Port 5 +	DP-I/O	PD/PU in CPU	PD 15k0hm +/-5% on Downstream Facing Port; PU 1.5k0hm +/-5% on Upstream Facing Port
B41	GND	Power Ground	PWR GND	-	-
B42	USB3-	USB 2.0 Data Pair Port 3 -	DP-I/O	PD/PU in CPU	PD 15k0hm +/-5% on Downstream Facing Port; PU 1.5k0hm +/-5% on Upstream Facing Port
B43	USB3+	USB 2.0 Data Pair Port 3 +	DP-I/O	PD/PU in CPU	PD 15k0hm +/-5% on Downstream Facing Port; PU 1.5k0hm +/-5% on Upstream Facing Port
B44	USB_0_1_OC#	USB Overcurrent Indicator Port 0/1	I-3.3	PU 15k in CPLD (S5)	resistor value can range from 5k0hm to 25k0hm
B45	USB1-	USB 2.0 Data Pair Port 1 -	DP-I/O	PD/PU in CPU	PD 15k0hm +/-5% on Downstream Facing Port; PU 1.5k0hm +/-5% on Upstream Facing Port
B46	USB1+	USB 2.0 Data Pair Port 1 +	DP-I/O	PD/PU in CPU	PD 15k0hm +/-5% on Downstream Facing Port; PU 1.5k0hm +/-5% on Upstream Facing Port
B47	EXCD1_PERST#	Express Card Reset Port 1	0-3.3	-	-
B48	EXCD1_CPPE#	Express Card Capable Card Request Port 1	I-3.3	PU 10k 3.3V (S0)	-
B49	SYS_RESET#	Reset Button Input	I-3.3	PU 10k 3.3V (S5)	-
B50	CB_RESET#	Carrier Board Reset	0-3.3	-	-
B51	GND	Power Ground	PWR GND	-	-
B52	PCIE_RX5+	Not Connected	nc	-	-
B53	PCIE_RX5-	Not Connected	nc	-	-
B54	GPO1	General Purpose Output 1	0-3.3	PD 100k	-
B55	PCIE_RX4+	Not Connected	nc	-	-
B56	PCIE_RX4-	Not Connected	nc	-	-
B57	GPO2	General Purpose Output 2	0-3.3	PD 100k	-

B58	PCIE_RX3+	PCI Express Lane 3 Receive +	DP-I	-	only available on no-LAN var.
B59	PCIE_RX3-	PCI Express Lane 3 Receive -	DP-I	-	only available on no-LAN var.
B60	GND	Power Ground	PWR GND	-	-
B61	PCIE_RX2+	PCI Express Lane 2 Receive +	DP-I	-	-
B62	PCIE_RX2-	PCI Express Lane 2 Receive -	DP-I	-	-
B63	GPO3	General Purpose Output 3	O-3.3	PD 100k	-
B64	PCIE_RX1+	PCI Express Lane 1 Receive +	DP-I	-	-
B65	PCIE_RX1-	PCI Express Lane 1 Receive -	DP-I	-	-
B66	WAKE0#	PCI Express Wake Event	I-3.3	PU 10k 3.3V (S5)	-
B67	WAKE1#	General Purpose Wake Event	I-3.3	PU 10k 3.3V (S5)	-
B68	PCIE_RX0+	PCI Express Lane 0 Receive +	DP-I	-	-
B69	PCIE_RX0-	PCI Express Lane 0 Receive -	DP-I	-	-
B70	GND	Power Ground	PWR GND	-	-
B71	LVDS_B0+	LVDS Channel B DAT0+	DP-0	-	-
B72	LVDS_B0-	LVDS Channel B DAT0-	DP-0	-	-
B73	LVDS_B1+	LVDS Channel B DAT1+	DP-0	-	-
B74	LVDS_B1-	LVDS Channel B DAT1-	DP-0	-	-
B75	LVDS_B2+	LVDS Channel B DAT2+	DP-0	-	-
B76	LVDS_B2-	LVDS Channel B DAT2-	DP-0	-	-
B77	LVDS_B3+	LVDS Channel B DAT3+	DP-0	-	-
B78	LVDS_B3-	LVDS Channel B DAT3-	DP-0	-	-
B79	LVDS_BKLT_EN	Panel Backlight On	O-3.3	PD 100k	-
B80	GND	Power Ground	PWR GND	-	-
B81	LVDS_B_CK+	LVDS Channel B Clock+	DP-0	-	-
B82	LVDS_B_CK-	LVDS Channel B Clock-	DP-0	-	-
B83	LVDS_BKLT_CTRL	Backlight Brightness Control	O-3.3	-	-
B84	VCC_5V_SBY	5V Standby	PWR 5V (S5)	-	optional (not necessary in single supply mode)
B85	VCC_5V_SBY	5V Standby	PWR 5V (S5)	-	optional (not necessary in single supply mode)
B86	VCC_5V_SBY	5V Standby	PWR 5V (S5)	-	optional (not necessary in single supply mode)
B87	VCC_5V_SBY	5V Standby	PWR 5V (S5)	-	optional (not necessary in single supply mode)
B88	BIOS_DIS1#	BIOS Selection Strap 1	I-3.3	PU 10k 3.3V (SPI)	PU might be powered during suspend
B89	CRT_RED	CRT_RED / Analog Video RGB-RED	OA	PD 150R	-
B90	GND	Power Ground	PWR GND	-	-
B91	CRT_GREEN	CRT_GREEN / Analog Video RGB-GREEN	OA	PD 150R	-
B92	CRT_BLUE	CRT_BLUE / Analog Video RGB-BLUE	OA	PD 150R	-
B93	CRT_HSYNC	CRT_HSYNC / Analog Video H-Sync	O-3.3	-	-
B94	CRT_VSYNC	CRT_VSYNC / Analog Video V-Sync	O-3.3	-	-
B95	CRT_DDC_CLK	CRT_DDC_CLK / Display Data Channel Clock	I/O-5	PU 2k21 5.0V_S0	-
B96	CRT_DDC_DATA	CRT_DDC_DATA / Display Data Channel Data	I/O-5	PU 2k21 5.0V_S0	-
B97	SPI_CS#	SPI Chip Select	O-3.3	-	-
B98	RSVD	Reserved for future use	nc	-	-
B99	RSVD	Reserved for future use	nc	-	-
B100	GND	Power Ground	PWR GND	-	-
B101	FAN_PWMOUT	Fan PWM Output	O-3.3	-	20V protection circuit implemented on module, PD on carrier board needed for proper operation
B102	FAN_TACHIN	Fan Tach Input	I-3.3	PU 47k 3.3V (S0)	20V protection circuit implemented on module
B103	SLEEP#	Sleep Button Input	I-3.3	PU 47k 3.3V (S5)	20V protection circuit implemented on module
B104	VCC_12V	Main Input Voltage (8.5-20V)	PWR 8.5-20V	-	-
B105	VCC_12V	Main Input Voltage (8.5-20V)	PWR 8.5-20V	-	-
B106	VCC_12V	Main Input Voltage (8.5-20V)	PWR 8.5-20V	-	-
B107	VCC_12V	Main Input Voltage (8.5-20V)	PWR 8.5-20V	-	-
B108	VCC_12V	Main Input Voltage (8.5-20V)	PWR 8.5-20V	-	-
B109	VCC_12V	Main Input Voltage (8.5-20V)	PWR 8.5-20V	-	-
B110	GND	Power Ground	PWR GND	-	-

6.4. Connector X1B Row C

Pin	Signal	Description	Type	Termination	Comment
C1	GND	Power Ground	PWR GND	-	-
C2	GND	Power Ground	PWR GND	-	-
C3	USB_SSRX0-	USB Super Speed Receive - (0)	DP-I	-	-
C4	USB_SSRX0+	USB Super Speed Receive + (0)	DP-I	-	-
C5	GND	Power Ground	PWR GND	-	-
C6	USB_SSRX1-	Not Connected	nc	-	-
C7	USB_SSRX1+	Not Connected	nc	-	-
C8	GND	Power Ground	PWR GND	-	-
C9	USB_SSRX2-	Not Connected	nc	-	-
C10	USB_SSRX2+	Not Connected	nc	-	-
C11	GND	Power Ground	PWR GND	-	-
C12	USB_SSRX3-	Not Connected	nc	-	-
C13	USB_SSRX3+	Not Connected	nc	-	-
C14	GND	Power Ground	PWR GND	-	-
C15	DDI1_PAIR6+	Not Connected	nc	-	-
C16	DDI1_PAIR6-	Not Connected	nc	-	-
C17	RSVD	Reserved for future use	nc	-	-
C18	RSVD	Reserved for future use	nc	-	-
C19	PCIE_RX6+	Not Connected	nc	-	-
C20	PCIE_RX6-	Not Connected	nc	-	-
C21	GND	Power Ground	PWR GND	-	-
C22	PCIE_RX7+	Not Connected	nc	-	-
C23	PCIE_RX7-	Not Connected	nc	-	-
C24	DDI1_HPD	DDI1 Hotplug Detect	I-3.3	PD 100k	-
C25	DDI1_PAIR4+	Not Connected	nc	-	-
C26	DDI1_PAIR4-	Not Connected	nc	-	-
C27	RSVD	Reserved for future use	nc	-	-
C28	RSVD	Reserved for future use	nc	-	-
C29	DDI1_PAIR5+	Not Connected	nc	-	-
C30	DDI1_PAIR5-	Not Connected	nc	-	-
C31	GND	Power Ground	PWR GND	-	-
C32	DDI2_CTRLCLK_AUX+	DDI2 CTRLCLK/AUX+	I/O-3.3	PD 100k	-
C33	DDI2_CTRLDATA_AUX-	DDI2 CTRLDATA/AUX-	I/O-3.3	PU 100k 3.3V (S0)	-
C34	DDI2_DDC_AUX_SEL	DDI2 DDC/AUX select	I-3.3	PD 1M	-
C35	RSVD	Reserved for future use	nc	-	-
C36	DDI3_CTRLCLK_AUX+	Not Connected	nc	-	-
C37	DDI3_CTRLDATA_AUX-	Not Connected	nc	-	-
C38	DDI3_DDC_AUX_SEL	Not Connected	nc	-	-
C39	DDI3_PAIR0+	Not Connected	nc	-	-
C40	DDI3_PAIR0-	Not Connected	nc	-	-
C41	GND	Power Ground	PWR GND	-	-
C42	DDI3_PAIR1+	Not Connected	nc	-	-
C43	DDI3_PAIR1-	Not Connected	nc	-	-
C44	DDI3_HPD	Not Connected	nc	-	-
C45	RSVD	Reserved for future use	nc	-	-
C46	DDI3_PAIR2+	Not Connected	nc	-	-
C47	DDI3_PAIR2-	Not Connected	nc	-	-
C48	RSVD	Reserved for future use	nc	-	-
C49	DDI3_PAIR3+	Not Connected	nc	-	-
C50	DDI3_PAIR3-	Not Connected	nc	-	-
C51	GND	Power Ground	PWR GND	-	-
C52	PEG_RX0+	Not Connected	nc	-	-
C53	PEG_RX0-	Not Connected	nc	-	-
C54	TYPE0#	n.c. for type 6 module	nc	-	-
C55	PEG_RX1+	Not Connected	nc	-	-
C56	PEG_RX1-	Not Connected	nc	-	-
C57	TYPE1#	n.c. for type 6 module	nc	-	-
C58	PEG_RX2+	Not Connected	nc	-	-
C59	PEG_RX2-	Not Connected	nc	-	-
C60	GND	Power Ground	PWR GND	-	-
C61	PEG_RX3+	Not Connected	nc	-	-
C62	PEG_RX3-	Not Connected	nc	-	-
C63	RSVD	Reserved for future use	nc	-	-
C64	RSVD	Reserved for future use	nc	-	-

C65	PEG_RX4+	Not Connected	nc	-	-
C66	PEG_RX4-	Not Connected	nc	-	-
C67	RSVD	Reserved for future use	nc	-	-
C68	PEG_RX5+	Not Connected	nc	-	-
C69	PEG_RX5-	Not Connected	nc	-	-
C70	GND	Power Ground	PWR GND	-	-
C71	PEG_RX6+	Not Connected	nc	-	-
C72	PEG_RX6-	Not Connected	nc	-	-
C73	GND	Power Ground	PWR GND	-	-
C74	PEG_RX7+	Not Connected	nc	-	-
C75	PEG_RX7-	Not Connected	nc	-	-
C76	GND	Power Ground	PWR GND	-	-
C77	RSVD	Reserved for future use	nc	-	-
C78	PEG_RX8+	Not Connected	nc	-	-
C79	PEG_RX8-	Not Connected	nc	-	-
C80	GND	Power Ground	PWR GND	-	-
C81	PEG_RX9+	Not Connected	nc	-	-
C82	PEG_RX9-	Not Connected	nc	-	-
C83	RSVD	Reserved for future use	nc	-	-
C84	GND	Power Ground	PWR GND	-	-
C85	PEG_RX10+	Not Connected	nc	-	-
C86	PEG_RX10-	Not Connected	nc	-	-
C87	GND	Power Ground	PWR GND	-	-
C88	PEG_RX11+	Not Connected	nc	-	-
C89	PEG_RX11-	Not Connected	nc	-	-
C90	GND	Power Ground	PWR GND	-	-
C91	PEG_RX12+	Not Connected	nc	-	-
C92	PEG_RX12-	Not Connected	nc	-	-
C93	GND	Power Ground	PWR GND	-	-
C94	PEG_RX13+	Not Connected	nc	-	-
C95	PEG_RX13-	Not Connected	nc	-	-
C96	GND	Power Ground	PWR GND	-	-
C97	RSVD	Reserved for future use	nc	-	-
C98	PEG_RX14+	Not Connected	nc	-	-
C99	PEG_RX14-	Not Connected	nc	-	-
C100	GND	Power Ground	PWR GND	-	-
C101	PEG_RX15+	Not Connected	nc	-	-
C102	PEG_RX15-	Not Connected	nc	-	-
C103	GND	Power Ground	PWR GND	-	-
C104	VCC_12V	Main Input Voltage (8.5-20V)	PWR 8.5-20V	-	-
C105	VCC_12V	Main Input Voltage (8.5-20V)	PWR 8.5-20V	-	-
C106	VCC_12V	Main Input Voltage (8.5-20V)	PWR 8.5-20V	-	-
C107	VCC_12V	Main Input Voltage (8.5-20V)	PWR 8.5-20V	-	-
C108	VCC_12V	Main Input Voltage (8.5-20V)	PWR 8.5-20V	-	-
C109	VCC_12V	Main Input Voltage (8.5-20V)	PWR 8.5-20V	-	-
C110	GND	Power Ground	PWR GND	-	-

6.5. Connector X1B Row D

Pin	Signal	Description	Type	Termination	Comment
D1	GND	Power Ground	PWR GND	-	-
D2	GND	Power Ground	PWR GND	-	-
D3	USB_SSTX0-	USB Super Speed Transmit - (0)	DP-0	-	-
D4	USB_SSTX0+	USB Super Speed Transmit + (0)	DP-0	-	-
D5	GND	Power Ground	PWR GND	-	-
D6	USB_SSTX1-	Not Connected	nc	-	-
D7	USB_SSTX1+	Not Connected	nc	-	-
D8	GND	Power Ground	PWR GND	-	-
D9	USB_SSTX2-	Not Connected	nc	-	-
D10	USB_SSTX2+	Not Connected	nc	-	-
D11	GND	Power Ground	PWR GND	-	-
D12	USB_SSTX3-	Not Connected	nc	-	-
D13	USB_SSTX3+	Not Connected	nc	-	-
D14	GND	Power Ground	PWR GND	-	-
D15	DDI1_CTRLCLK_AUX+	DDI1 CTRLCLK/AUX+	I/O-3.3	PD 100k	-
D16	DDI1_CTRLDATA_AUX-	DDI1 CTRLDATA/AUX-	I/O-3.3	PU 100k 3.3V (S0)	-
D17	RSVD	Reserved for future use	nc	-	-
D18	RSVD	Reserved for future use	nc	-	-
D19	PCIE_TX6+	Not Connected	nc	-	-
D20	PCIE_TX6-	Not Connected	nc	-	-
D21	GND	Power Ground	PWR GND	-	-
D22	PCIE_TX7+	Not Connected	nc	-	-
D23	PCIE_TX7-	Not Connected	nc	-	-
D24	RSVD	Reserved for future use	nc	-	-
D25	RSVD	Reserved for future use	nc	-	-
D26	DDI1_PAIR0+	DDI1 Pair 0 +	DP-0	-	-
D27	DDI1_PAIR0-	DDI1 Pair 0 -	DP-0	-	-
D28	RSVD	Reserved for future use	nc	-	-
D29	DDI1_PAIR1+	DDI1 Pair 1 +	DP-0	-	-
D30	DDI1_PAIR1-	DDI1 Pair 1 -	DP-0	-	-
D31	GND	Power Ground	PWR GND	-	-
D32	DDI1_PAIR2+	DDI1 Pair 2 +	DP-0	-	-
D33	DDI1_PAIR2-	DDI1 Pair 2 -	DP-0	-	-
D34	DDI1_DDC_AUX_SEL	DDI1 DDC/AUX select	I-3,3	PD 1M	-
D35	RSVD	Reserved for future use	nc	-	-
D36	DDI1_PAIR3+	DDI1 Pair 3 +	DP-0	-	-
D37	DDI1_PAIR3-	DDI1 Pair 3 -	DP-0	-	-
D38	RSVD	Reserved for future use	nc	-	-
D39	DDI2_PAIR0+	DDI2 Pair 0 +	DP-0	-	-
D40	DDI2_PAIR0-	DDI2 Pair 0 -	DP-0	-	-
D41	GND	Power Ground	PWR GND	-	-
D42	DDI2_PAIR1+	DDI2 Pair 1 +	DP-0	-	-
D43	DDI2_PAIR1-	DDI2 Pair 1 -	DP-0	-	-
D44	DDI2_HPD	DDI2 Hotplug Detect	I-3,3	PD 100k	-
D45	RSVD	Reserved for future use	nc	-	-
D46	DDI2_PAIR2+	DDI2 Pair 2 +	DP-0	-	-
D47	DDI2_PAIR2-	DDI2 Pair 2 -	DP-0	-	-
D48	RSVD	Reserved for future use	nc	-	-
D49	DDI2_PAIR3+	DDI2 Pair 3 +	DP-0	-	-
D50	DDI2_PAIR3-	DDI2 Pair 3 -	DP-0	-	-
D51	GND	Power Ground	PWR GND	-	-
D52	PEG_TX0+	Not Connected	nc	-	-
D53	PEG_TX0-	Not Connected	nc	-	-
D54	PEG_LANE_RV#	Not Connected	nc	-	-
D55	PEG_TX1+	Not Connected	nc	-	-
D56	PEG_TX1-	Not Connected	nc	-	-
D57	TYPE2#	GND for type 6 module	PWR	-	-
D58	PEG_TX2+	Not Connected	nc	-	-
D59	PEG_TX2-	Not Connected	nc	-	-
D60	GND	Power Ground	PWR GND	-	-
D61	PEG_TX3+	Not Connected	nc	-	-
D62	PEG_TX3-	Not Connected	nc	-	-
D63	RSVD	Reserved for future use	nc	-	-
D64	RSVD	Reserved for future use	nc	-	-

D65	PEG_TX4+	Not Connected	nc	-	-
D66	PEG_TX4-	Not Connected	nc	-	-
D67	GND	Power Ground	PWR GND	-	-
D68	PEG_TX5+	Not Connected	nc	-	-
D69	PEG_TX5-	Not Connected	nc	-	-
D70	GND	Power Ground	PWR GND	-	-
D71	PEG_TX6+	Not Connected	nc	-	-
D72	PEG_TX6-	Not Connected	nc	-	-
D73	GND	Power Ground	PWR GND	-	-
D74	PEG_TX7+	Not Connected	nc	-	-
D75	PEG_TX7-	Not Connected	nc	-	-
D76	GND	Power Ground	PWR GND	-	-
D77	RSVD	Reserved for future use	nc	-	-
D78	PEG_TX8+	Not Connected	nc	-	-
D79	PEG_TX8-	Not Connected	nc	-	-
D80	GND	Power Ground	PWR GND	-	-
D81	PEG_TX9+	Not Connected	nc	-	-
D82	PEG_TX9-	Not Connected	nc	-	-
D83	RSVD	Reserved for future use	nc	-	-
D84	GND	Power Ground	PWR GND	-	-
D85	PEG_TX10+	Not Connected	nc	-	-
D86	PEG_TX10-	Not Connected	nc	-	-
D87	GND	Power Ground	PWR GND	-	-
D88	PEG_TX11+	Not Connected	nc	-	-
D89	PEG_TX11-	Not Connected	nc	-	-
D90	GND	Power Ground	PWR GND	-	-
D91	PEG_TX12+	Not Connected	nc	-	-
D92	PEG_TX12-	Not Connected	nc	-	-
D93	GND	Power Ground	PWR GND	-	-
D94	PEG_TX13+	Not Connected	nc	-	-
D95	PEG_TX13-	Not Connected	nc	-	-
D96	GND	Power Ground	PWR GND	-	-
D97	RSVD	Reserved for future use	nc	-	-
D98	PEG_TX14+	Not Connected	nc	-	-
D99	PEG_TX14-	Not Connected	nc	-	-
D100	GND	Power Ground	PWR GND	-	-
D101	PEG_TX15+	Not Connected	nc	-	-
D102	PEG_TX15-	Not Connected	nc	-	-
D103	GND	Power Ground	PWR GND	-	-
D104	VCC_12V	Main Input Voltage (8.5-20V)	PWR 8.5-20V	-	-
D105	VCC_12V	Main Input Voltage (8.5-20V)	PWR 8.5-20V	-	-
D106	VCC_12V	Main Input Voltage (8.5-20V)	PWR 8.5-20V	-	-
D107	VCC_12V	Main Input Voltage (8.5-20V)	PWR 8.5-20V	-	-
D108	VCC_12V	Main Input Voltage (8.5-20V)	PWR 8.5-20V	-	-
D109	VCC_12V	Main Input Voltage (8.5-20V)	PWR 8.5-20V	-	-
D110	GND	Power Ground	PWR GND	-	-



The termination resistors in these tables are already mounted on the module. Refer to the design guide for information about additional termination resistors.

7. BIOS Operation

The BIOS (Basic Input and Output System) or UEFI (Unified Extensible Firmware Interface) records hardware parameters of the system in the CMOS on the Computer-on-Module. It's major functions include execution of the POST(Power-On-Self-Test) during system start-up, saving system parameters and loading the operating system. The BIOS includes a BIOS Setup program that allows to modify system configuration settings. The module is equipped with Phoenix SecureCore, which is located in an onboard SPI serial flash memory.

7.1. Determining the BIOS Version

To determine the BIOS version currently used on the Computer-on-Modules please check System Information Page inside Setup

7.2. BIOS Update

Kontron provides continuous BIOS updates for Computer-on-Modules. The updates are provided for download on <http://emdcustomersection.kontron.com> with detailed change descriptions within the according Product Change Notification (PCN). Please register for EMD Customer Section to get access to BIOS downloads and PCN service.

Modules with BIOS Region/Setup only inside the flash can be updated with AFU utilities (usually 1-3MB BIOS binary file size) directly. Modules with Intel® Management Engine, Ethernet, Flash Descriptor and other options additionally to the BIOS Region (usually 4-16MB BIOS binary file size) requires a different update process with Intel Flash Utility FPT and a wrapper to backup and restore configurations and the MAC address. Therefore it is strongly recommended to use the batch file inside the BIOS download package available on EMD Customer Section.

- » Boot the module to DOS/EFI Shell with access to the BIOS image and Firmware Update Utility provided on EMD Customer Section
- » Execute Flash.bat in DOS or Flash.nsh in EFI Shell



Any modification of the update process may damage your module!

7.3. POST Codes

Important POST codes during boot-up

8B	Booted to DOS
68	Booted to Setup / EFI Shell
00	Booted to Windows

7.4. Setup Guide

The Setup Utility changes system behavior by modifying the Firmware configuration. The setup program uses a number of menus to make changes and turn features on or off.

Functional keystrokes in POST:

[F2]	Enter Setup
[F5]	Boot Menu
[ESC] + [2]	Enter Setup via Remote Keyboard in Console Redirection Mode (depending on console Settings F2 may not be supported)

Functional keystrokes in Setup:

[F1]	Help
[F9]	Load default settings
[F10]	Save and Exit

Menu Bar

The menu bar at the top of the window lists different menus. Use the left/right arrow keys to make a selection.

Legend Bar

Use the keys listed in the legend bar on the bottom to make your selections or exit the current menu. The table below describes the legend keys and their alternates.

Key	Function
← or → Arrow key	Select a menu.
↑ or ↓ Arrow key	Select fields in current menu.
<Home> or <End>	Move cursor to top or bottom of current window.
<PgUp> or <PgDn>	Move cursor to next or previous page.
+/- or F5/F6	Change Option
<Enter>	Execute command or select submenu.

Selecting an Item

Use the ↑ or ↓ key to move the cursor to the field you want. Then use the + and – keys to select a value for that field. The Save Value commands in the Exit menu save the values displayed in all the menus.

Displaying Submenus

Use the ← or → key to move the cursor to the submenu you want. Then press <Enter>. A pointer (▶) marks all submenus.

Item Specific Help Window

The Help window on the right side of each menu displays the Help text for the selected item. It updates as you move the cursor to each field.

General Help Window

Pressing <F1> on a menu brings up the General Help window that describes the legend keys and their alternates. Press <Esc> to exit the General Help window.

7.5. BIOS Setup

7.5.1. Main

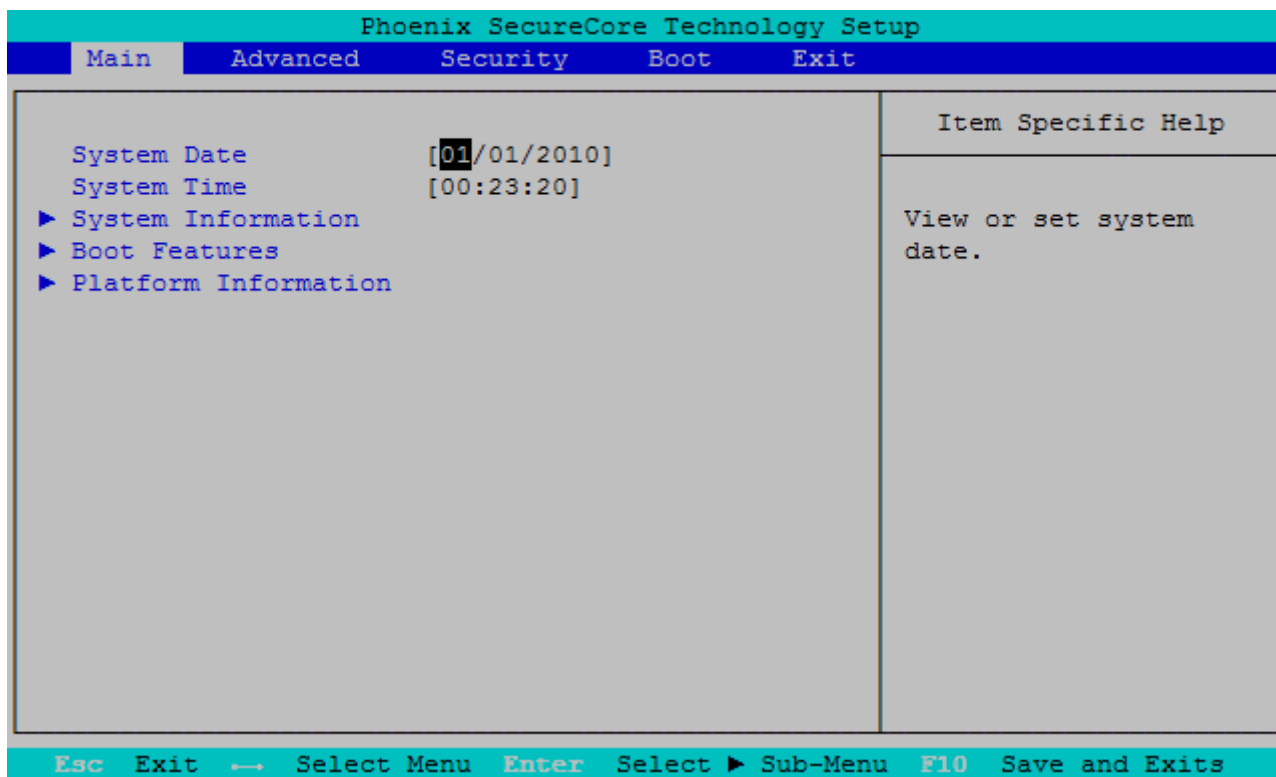

Feature	Options	Description
System Date	[mm/dd/yyyy]	Set the Date. Use 'Tab' to switch between Date elements
System Time	[hh:mm:ss]	Set the Time. Use 'Tab' to switch between Time elements

System Information

Phoenix SecureCore Technology Setup	
Main	
System Information	
BIOS Version	CVV6R112 X64
Build Time	12/01/2014
Processor Type	Intel(R) Atom(TM) CPU E3845 @ 1.91GHz
Processor Speed	1.925 GHz
System Memory Speed	1333 MHz
L2 Cache RAM	2048 KB
Total Memory	8192 MB
[1]	4096 MB (DDR3- 1333) @ DIMM0
[2]	4096 MB (DDR3- 1333) @ DIMM1

Esc Exit → Select Menu Enter Select ► Sub-Menu F10 Save and Exits

Boot Features

Phoenix SecureCore Technology Setup		
Main		
Boot Features		Item Specific Help
NumLock:	[On]	Selects Power-on state for NumLock.
Timeout	[1]	
CSM Support	[Yes]	
Quick Boot	[Disabled]	
Dark Boot	[Disabled]	
Diagnostic Splash Screen	[Disabled]	
Diagnostic Summary Screen	[Disabled]	
BIOS Level USB	[Enabled]	
Console Redirection	[Disabled]	
Allow Hotkey in S4 resume	[Enabled]	
UEFI Boot	[Enabled]	
Legacy Boot	[Enabled]	
Boot in Legacy Video Mode	[Disabled]	
Load OPROM	[On Demand]	
Boot Priority	[UEFI First]	

Esc Exit → Select Menu Enter Select ► Sub-Menu F10 Save and Exits

Feature	Options	Description
NumLock	On Off	Selects Power-on state for NumLock
Timeout	1	Number of seconds that P.O.S.T will wait for the user input before booting
CSM Support	Yes No	Enables or Disables the UEFI CSM (Compatibility Support Module) to support legacy PC boot process. Both legacy and UEFI boots are feasible
Quick Boot	Disabled Enabled	Enable or Disable Quick Boot
Dark Boot	Disabled Enabled	Enable or Disable Dark Boot
Diagnostic Splash Screen	Disabled Enabled	Enable or Disable the Diagnostic Splash Screen
Diagnostic Summary Screen	Disabled Enabled	Display the Diagnostic Summary Screen during boot
BIOS Level USB	Enabled Disabled	Enable/Disable all BIOS support for USB in order to reduce boot time. Note that this will prevent using a USB keyboard in setup or a USB biometric scanner such as a fingerprint reader to control access to setup, but does not prevent the operating system from supporting such hardware
USB Legacy	Enabled Disabled	Enable/Disable USB BIOS SMM support for mouse, keyboard, mass storage, etc, in legacy operating systems such as DOS
Console Redirection	Disabled Enabled	Enable/Disable Universal Console Redirection
- Console Port	All Onboard COM1 Onboard COM2 SIO COM1 SIO COM2	Select Port for console redirection. Note: the respective port has to be enabled in setup!
- Terminal Type	ANSI VT100 VT100+ UTF8	Set terminal type of UCR
- Baudrate	9600 19200 38400 57600 115200	Set terminal type of UCR
- Flow Control	None	Set flow control method for UCR. None = No flow

	RTS/CTS XON/XOFF	control, RTS/CTS = Hardware flow control, XON/XOFF = Software flow control
- Continue C.R. after POST	Enabled Disabled	Enables Console Redirection after OS has loaded
Allow Hotkey in S4 resume	Enabled Disabled	Enable hotkey detection when system resuming from Hibernate state
UEFI Boot	Enabled Disabled	Enable the UEFI boot
Legacy Boot	Enabled \ Disabled	Enable the Legacy boot
Boot in Legacy Video Mode	Disabled Enabled	Enable to force the display adapter to switch the video mode to Text Mode 3 at the end of BIOS POST for non-UEFI boot mode (Legacy Boot). Some legacy software, such as DUET, requires that the BIOS explicitly enter text video mode prior to boot
Load OPROM	On Demand All	Load all OPROMs or on demand according to the boot device
Boot Priority	UEFI First Legacy First	Select priority of boot option between UEFI and Legacy

Platform Information

Phoenix SecureCore Technology Setup	
Main	
Platform Information	Item Specific Help
Module Information	
Product Name	COMe-cBTi6
Revision	1.0.0
Serial #	LHDOH0023
MAC Address	00:E0:4B:3F:11:3C
CPLD Rev	P101.0002 Release
Boot Counter	63

Esc Exit → Select Menu Enter Select ► Sub-Menu F10 Save and Exits

7.5.2. Advanced

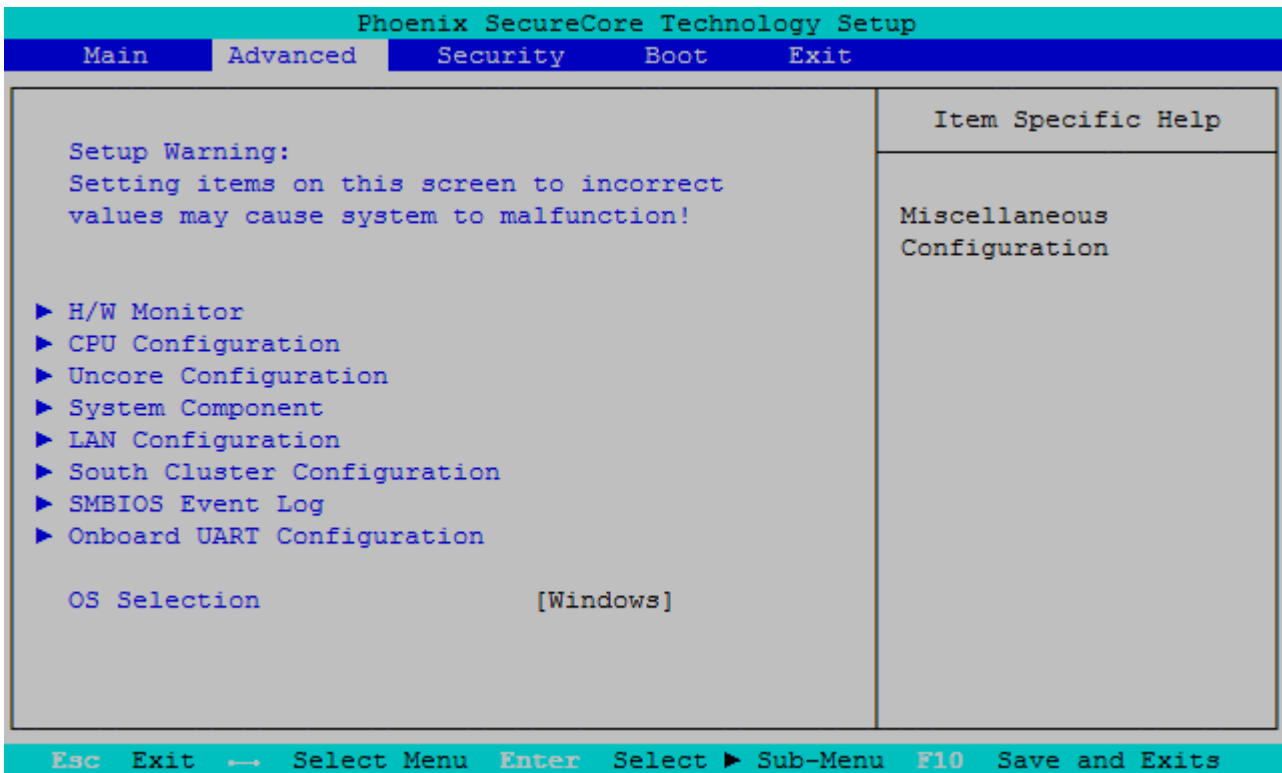

Feature	Options	Description
OS Selection	Windows Linux Android	Select the Operating System family to be booted

Miscellaneous

Phoenix SecureCore Technology Setup	
Advanced	
Miscellaneous	Item Specific Help
Miscellaneous Configuration	Watchdog Configuration.
▶ Watchdog	
I2C Speed [100]	
S5 Eco [Disabled]	
Smart Battery Configuration [Disabled]	
Reset Button Behavior [Chipset Reset]	
Esc Exit → Select Menu Enter Select ▶ Sub-Menu F10 Save and Exits	

Feature	Options	Description
I2C Speed	100	Select I2C Bus Speed in kHz from 1kHz to 400kHz
S5 Eco	Disabled Enabled	Enable/Disable Kontron S5 Eco mode. Reduces supply current in Soft Off (S5) to less than 1mA. If enabled, power button is the only wake-up source in S5! See chapter S5 Eco for further details
Smart Battery Configuration	Disabled Auto Charger Manager	Enable/Disable Smart Battery System Support (e.g. Kontron M.A.R.S.)
Reset Button Behavior	Chipset Reset Power Cycle	Select the system behavior on reset button event

Watchdog

Phoenix SecureCore Technology Setup	
Advanced	
Watchdog	Item Specific Help
Watchdog Configuration. Auto-reload [Disabled] Global Lock [Disabled] Stage 1 Mode [Disabled]	Enable automatic reload of watchdog timers on timeout.
Esc Exit → Select Menu Enter Select ► Sub-Menu F10 Save and Exits	

Feature	Options	Description
Auto-reload	Disabled Enabled	Enable automatic reload of watchdog timers on timeout
Global Lock	Disabled Enabled	If set to enabled, all Watchdog registers (except WD_KICK) become read only until the board is reset
Stage 1 Mode	Disabled Reset NMI SCI Delay	Select Action for first Watchdog stage
- Assert WDT Signal	Enabled Disabled	Enable/Disable assertion of WDT signal to baseboard on stage timeout
- Stage 1 Timeout	1s 5s 10s 30s 1m 3m 10m 30m	Select Timeout value for first watchdog stage
Stage 2 Mode	Disabled Reset NMI SCI	Select Action for second Watchdog stage
- Assert WDT Signal	Disabled Enabled	Enable/Disable assertion of WDT signal to baseboard on stage timeout
- Stage 2 Timeout	1s 5s 10s 30s 1m 3m 10m 30m	Select Timeout value for second watchdog stage

H/W Monitor

Phoenix SecureCore Technology Setup

Advanced

H/W Monitor NCT7802Y	Item Specific Help
<pre> Temperature Measurement CPU Temperature (Analog) [+31 C] CPU Temperature (DTS) [+39 C] Module Temperature [+30 C] Fan Measurement CPU Fan [N/A] Fan Pulse [2] Fan Control [Auto] Fan Trip Point [45] Trip Point Speed [50] Reference Temperature [CPU Temperature (Ana)] External Fan [1265 RPM] Fan Pulse [2] Fan Control [Auto] Fan Trip Point [45] Trip Point Speed [50] Reference Temperature [CPU Temperature (Ana)] Voltage Measurement Widerange Vcc [+12.03 V] 5.0V Standby [+5.16 V] Batt volt at COMe pin [+2.96 V] </pre>	<p>▲</p> <p>Number of pulses the fan produces during one revolution. Range: 1-4</p> <p>▼</p>

Esc Exit → Select Menu Enter Select ▶ Sub-Menu F10 Save and Exits

Feature	Value/Options	Description
CPU Temperature (Analog)	xx°C	Shows the measured temperature of the CPU Diode with onboard HWM
CPU Temperature (DTS)	xx°C	Shows the internal digital CPU temperature (DTS)
Module Temperature	xx°C	Shows the internal hardware-monitor temperature
CPU FAN	xxxx rpm	Shows the fan speed of onboard FAN connector
Fan Pulse	2	Number of pulses the CPU fan produces during one revolution. Range 1-4
FAN Control	Disabled Manual Auto	Set fan control mode. 'Disable' will totally stop the fan
Fan Trip Point	45	Temperature where fan accelerates. Range 20 - 80°C
Fan Speed	70	Manual fan speed in %. Minimum value is 30 (in Manual mode only)
Trip Point Speed	50	Fan speed at trip point in %. Minimum value is 30. Fan always runs at 100% at Tjmax - 10°C
Reference Temperature	CPU Temperature (Analog) Module Temperature	Determines the temperature source which is used for automatic fan control
External FAN	xxxx rpm	Shows the fan speed of external COME FAN
Fan Pulse	2	Select the number of pulses the external fan produces during one revolution. Range 1-4
FAN Control	Disabled Manual Auto	Set fan control mode. 'Disable' will totally stop the fan
Fan Trip Point	45	Temperature where fan accelerates. Range 20 - 80°C
Fan Speed	70	Manual fan speed in %. Minimum value is 30 (in Manual mode only)
Trip Point Speed	50	Fan speed at trip point in %. Minimum value is 30. Fan

		always runs at 100% at $T_{jmax} - 10^{\circ}C$
Reference Temperature	CPU Temperature (Analog) Module Temperature	Determines the temperature source which is used for automatic fan control
Widerange Vcc	x.xx V	Shows the Module Main Input Voltage
5.0V Standby	x.xx V	Shows the 5V Standby Voltage input
Batt volt at COMe pin	x.xx V	Shows the RTC Battery Voltage input measured at COMe connector

CPU Configuration

Phoenix SecureCore Technology Setup		
Advanced		
CPU Configuration		Item Specific Help
CPU Configuration		
Execute Disable Bit	[Enable]	Execute Disable Bit prevent certain classes of malicious buffer overflow attacks when combined with a supporting OS
Limit CPUID Maximum	[Disable]	
Bi-directional PROCHOT#	[Enable]	
VTX-2	[Enable]	
TM1	[Enable]	
DTS	[Enable]	
Intel® Hyper-Threading Technology	Not Supported	
▶ CPU Power Management		
Esc Exit → Select Menu Enter Select ▶ Sub-Menu F10 Save and Exits		

Feature	Options	Description
Execute Disable Bit	Enable Disable	Execute Disable Bit prevent certain classes of malicious buffer overflow attacks when combined with a supporting OS
Limit CPUID Maximum	Enable Disable	Disabled for Windows XP
Bi-directional PROCHOT#	Enable Disable	When a processor thermal sensor trips (either core), the PROCHOT# will be driven. If bi-direction is enabled, external agents can drive PROCHOT# to throttle the processor
VTX-2	Enable Disable	Enables or Disables the VT-x2 Mode support
TM1	Enable Disable	Enables or Disables the Thermal Management 1 support
DTS	Enable Disable	Enables or Disables the Digital Thermal Sensor

CPU Power Management

Phoenix SecureCore Technology Setup		
Advanced		
CPU Power Management		Item Specific Help
System Power Options		Enable processor performance states (P-States).
Intel(R) SpeedStep(tm)	[Enable]	
Boot performance mode	[Max Performance]	
Intel® Turbo Boost Technology	[Enable]	
C-States	[Enable]	
Enhanced C-states	[Enable]	
Max C State	[C7]	
Esc Exit → Select Menu Enter Select ► Sub-Menu F10 Save and Exits		

Feature	Options	Description
Intel® SpeedStep(TM)	Enabled Disabled	Enable/Disable processor performance states (P-States)
Boot Performance Mode	Max Performance Max Battery	Select the performance state that the BIOS sets before OS hand-off
Intel® Turbo Boost Technology	Enabled Disabled	Enable to automatically allow processor cores to run faster than the base operating frequency if it's operating below power, current, and temperature specification limits. This option is only valid for CPUs supporting Intel® Turbo Boost Technology
C-States	Enabled Disabled	Enable processor idle power saving states
Enhanced C-States	Enabled Disabled	Enables or Disables C1E/C2E/C4E. When enabled, CPU will switch to minimum speed when all cores enter C-State
Max C-State	C7 C6 C1	Controls the maximum C-State allowed for the processor

Uncore Configuration

Phoenix SecureCore Technology Setup		
Advanced		
Uncore Configuration	Item Specific Help	
IGD Configuration Integrated Graphics Device [Enable] Primary Display [Auto] RC6 (Render Standby) [Enable] GTT Size [2MB] Aperture Size [256MB] DVMT Pre-Allocated [64M] IGD Turbo [Auto] Spread Spectrum clock [Disable] ▶ IGD - LCD Control	Enable : Enable Integrated Graphics Device (IGD) when selected as the Primary Video Adaptor. Disable: Always disable IGD	
Esc Exit → Select Menu Enter Select ▶ Sub-Menu F10 Save and Exits		

Feature	Options	Description
Integrated Graphics Device	Disable Enable	Enable: enable Integrated Graphics Device (IGD) when selected as the Primary Video Adaptor. Disable: Always disable IGD
Primary Display	Auto IGD PCIe SG	Select which of IGD/PCIe Graphics Devices should be Primary Display or select SG for Switchable/Hybrid Graphics
RC6 (Render Standby)	Disable Enable	Enable or Disable Render Standby support
GTT Size	1MB 2MB	Select the GTT Memory Size of IGD
Aperture Size	128MB 256MB 512MB	Select the Graphics Aperture Size
DVMT Pre-Allocated	64M 96M 128M 160M 192M 224M 256M 288M 320M 352M 384M 416M 448M 480M 512M	Select DVMT 5.0 Pre-Allocated (fixed) Graphics Memory size used by the Internal Graphics device
IGD Turbo	Auto Enable Disable	Select the IGD Turbo feature
Spread Spectrum clock	Disable Enable	Enable or Disable clock chip Spread Spectrum feature

IGD - LCD Control

Phoenix SecureCore Technology Setup		
Advanced		
IGD Configuration	Item Specific Help	
IGD managed by: Legacy Video BIOS [3777]		
IGD - Boot Type	[Auto]	Select the Video Device activated during POST. This has no effect if external graphics are present.
Backlight Control	[I2C]	
Backlight Value	[128]	
Module switch LVDS - DDI2	[Activate LVDS]	
LVDS Clock Center Spreading	[No Spreading]	
EFP1 Type	[DP with HDMI/DVI]	
Mode Persistence	[Disabled]	
Center Mode	[Disabled]	
Esc Exit → Select Menu Enter Select ▶ Sub-Menu F10 Save and Exits		

Feature	Options	Description
IGD - Boot Type	Auto CRT EFP LFP EFP2	Select the Integrated Graphics Video Device activated during POST. LFP = Local Flat Panel (LVDS/eDP). EFP = External Flat Panel (Display Port 1), EFP2 = External Flat Panel 2 (Display Port 2)
IGD - Secondary Boot Type	Disabled CRT EFP LFP EFP2	Select Secondary Display Device
LFP Type	AUTO VGA 640×480 1×18 WVGA 800×480 1×18 SVGA 800×600 1×18 XGA 1024×768 1×18 XGA 1024×768 1×24 WXGA 1280×768 1×24 WXGA 1280×800 1×18 WXGA 1366×768 1×24 WSVGA 1024×600 1×18 WSVGA 1024×600 1×24 Custom PAID	Select LFP used by Internal Graphics Device by selecting the appropriate panel setup item
Backlight Control	None/External PWM PWM Inverted I2C I2C Inverted	Backlight Control Setting
Backlight Value	128	Set LCD backlight brightness (0-255)
Module switch LVDS-DDI2	Activate LVDS Activate DDI2	Choose between LVDS and DDI2 display option
LVDS Clock Center Spreading	No Spreading 0.5% 1.0% 1.5% 2.0% 2.5%	Select LVDS clock frequency center spreading depth
EFP1 Type	DisplayPort Only DP with HDMI/DVI HDMI/DVI	Integrated HDMI/DisplayPort Configuration with External Connectors
EFP2 Type	DisplayPort Only DP with HDMI/DVI HDMI/DVI	Integrated HDMI/DisplayPort Configuration with External Connectors

Mode Persistence	Disabled Enabled	Enables/Disables Mode Persistence
Center Mode	Disabled EFP	Select the Display Device that should be centered

System Component

Phoenix SecureCore Technology Setup	
Advanced	
System Component	Item Specific Help
PMIC Configuration PNP Setting [Power&Performance]	Select PNP setting mode, Disable, Performance, Power or Power&Performance mode
Esc Exit ← Select Menu Enter Select ► Sub-Menu F10 Save and Exits	

Feature	Options	Description
PNP Setting	Disable Power & Performance Ax Stepping Bx Stepping	Select PNP setting mode, Disable, Performance, Power or Power&Performance mode

LAN Configuration

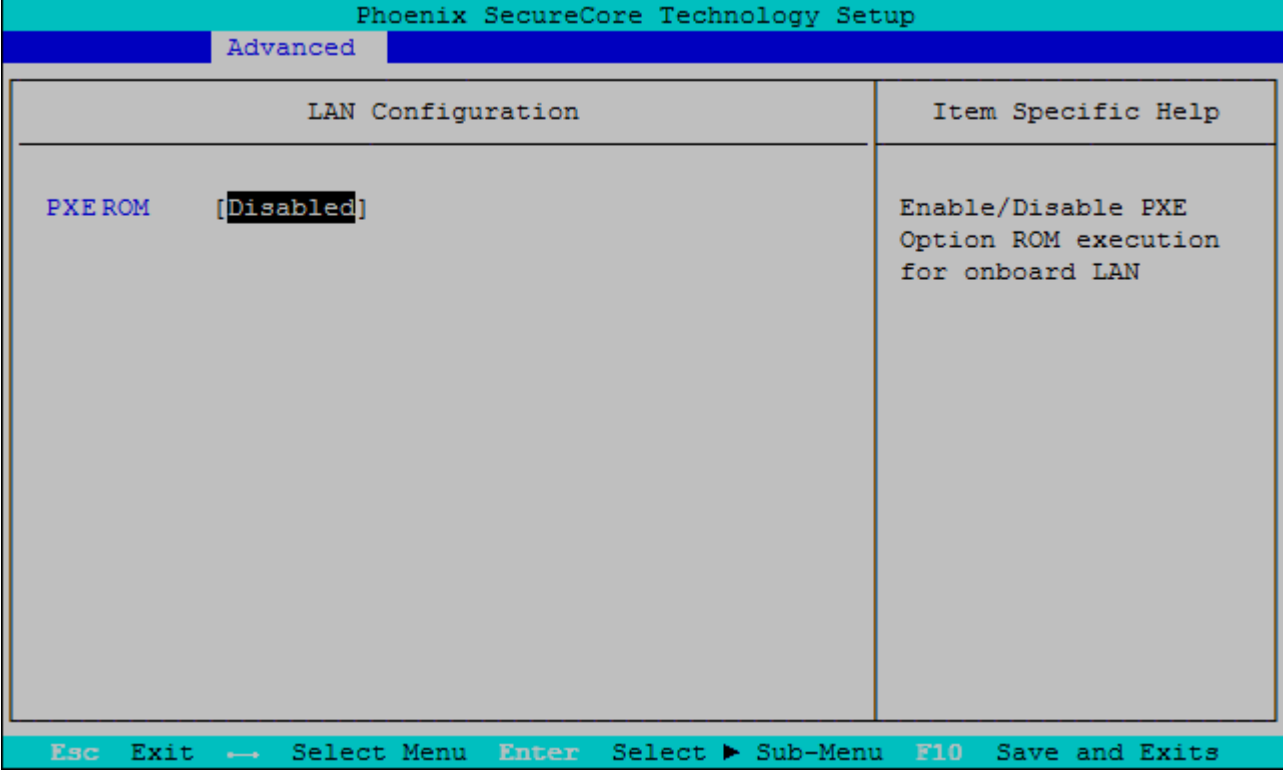

Feature	Options	Description
PXE ROM	Disabled Onboard only Addon only Both	Enable/Disable PXE Option ROM execution for onboard LAN

South Cluster Configuration

Phoenix SecureCore Technology Setup	
Advanced	
South Cluster Configuration	Item Specific Help
<ul style="list-style-type: none"> ▶ PCI Express Configuration ▶ USB Configuration ▶ Audio Configuration ▶ SATA Drives ▶ LPSS & SCC Configuration ▶ Miscellaneous Configuration 	PCI Express Configuration Settings
Esc Exit → Select Menu Enter Select ▶ Sub-Menu F10 Save and Exits	

PCI Express Configuration

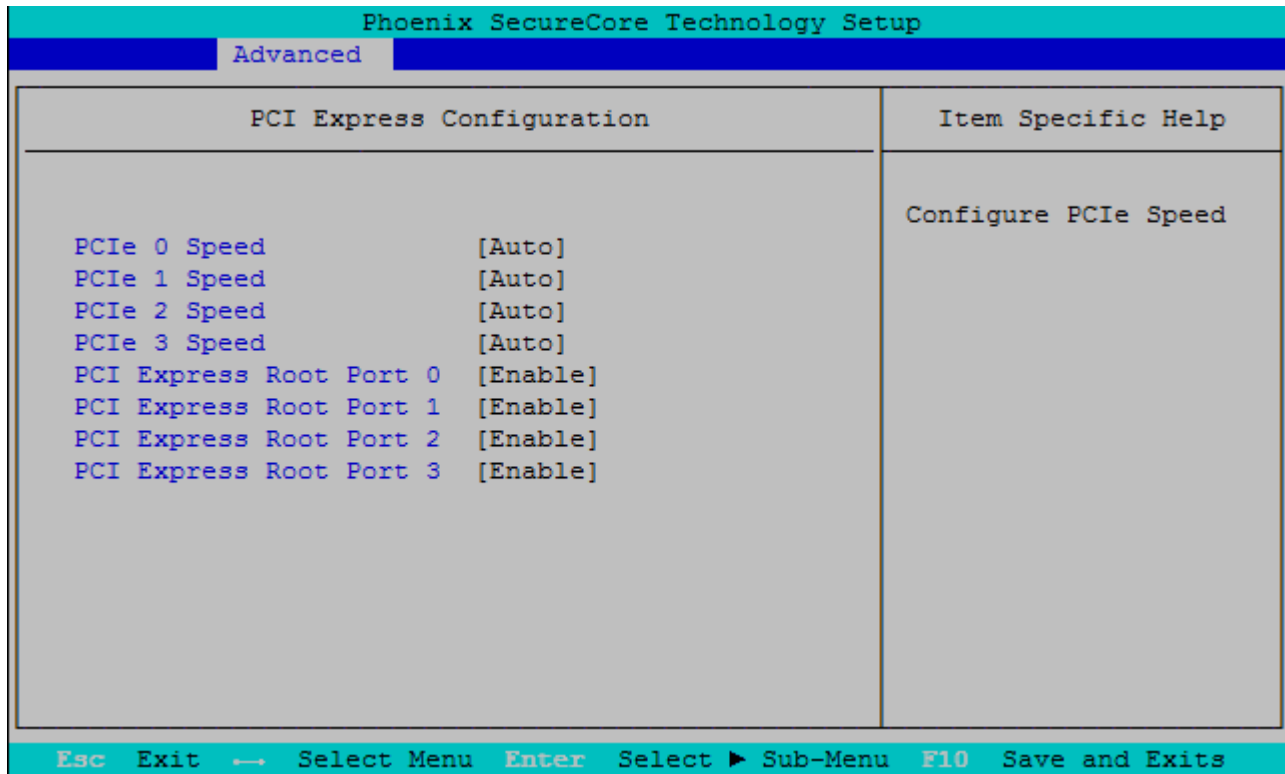

Feature	Options	Description
PCIe Speed	Auto Gen1 Gen2	Select PCIe Speed to Gen1 or Gen2
PCI Express Root Port	Disable Enable	Control the PCI Express Root Port

USB Configuration

Phoenix SecureCore Technology Setup	
Advanced	
USB Configuration	Item Specific Help
xHCI Mode [Smart Auto] EHCI Controller [Enable] USB Per-Port Control [Enable] USB Port #0 [Enable] USB Port #1 [Enable] USB Port #2 [Enable] USB Port #3 [Enable]	Mode of operation of xHCI controller. This will also influence EHCI controller settings since certain combinations of those modes are not allowed. 'Smart Auto' mode is supposed to solve USB issues under Windows 7
Esc Exit ← Select Menu Enter Select ► Sub-Menu F10 Save and Exits	

Feature	Options	Description
xHCI Mode	Smart Auto Enable Disable	Mode of operation of xHCI controller. This will also influence EHCI controller settings since certain combinations of those modes are not allowed. 'SMART Auto' Mode is required for OS with external Driver (e.g. Windows 7), 'Enabled' is recommended for OS with integrated USB 3.0 Support (e.g. Windows 8). Please note, the USB HSIC Hub for COMe USB Ports #4-7 is linked to xHCI controller which allows operation of these USB ports in OS with USB 3.0 driver only (no support in DOS or EFI Shell)
USB Per-Port Control	Disable Enable	Controls each of the CPU USB ports (COMe USB #0-3)
- USB Port #0 - USB Port #1 - USB Port #2 - USB Port #3	Disabled Enabled	Enable/Disable USB port

Audio Configuration

Phoenix SecureCore Technology Setup		
Advanced		
Audio Configuration		Item Specific Help
Audio Configuration		Control Detection of the HDAudio device.
Audio Controller	[Enable]	
HDAudio VCI Enable	[Enable]	Disabled = Azalia will be
HDAudio Docking Support Enable	[Disable]	unconditionally
HDAudio PME Enable	[Enable]	disabled
HDAudio HDMI Codec	[Enable]	
HDA_SDIO	[HDA_SDIO]	Enabled = Azalia will be unconditionally
HDA_SDI1	[Disable]	Enabled
		Auto = Azalia will be enabled if present, disabled otherwise

Esc Exit ← Select Menu Enter Select ► Sub-Menu F10 Save and Exits

Feature	Options	Description
Audio Controller	Enable Disable	Enable / Disable High Definition Audio interface
- HDAudio VCI Enable	Enable Disable	Enable / Disable Virtual Channel 1 of Audio Controller
- HDAudio Docking Support Enable	Enable Disable	Enable / Disable HDAudio Docking Support of Audio Controller
- HDAudio PMCE Enable	Enable Disable	Enable / Disable Power Management capability of Audio Controller
- HDAudio HDMI Codec	Enable Disable	Enable / Disable internal HDMI codec for HDAudio
HDA_SDIO	HDA_SDIO Disable	HDAudio Codec connected on HDA_SDIO signal
HDA_SDI1	HDA_SDI1 Disable	HDAudio Codec connected on HDA_SDI1 signal

SATA Drives

Phoenix SecureCore Technology Setup	
Advanced	
SATA Drives	Item Specific Help
SATA Drives Chipset-SATA Controller Configuration Chipset SATA [Enable] SATA Test Mode [Disable] Chipset SATA Mode [AHCI] SATA Port 0 Hot Plug Capability [Disable] SATA Port 1 Hot Plug Capability [Disable]	Enables or Disables the Chipset SATA Controller. The Chipset SATA controller supports the 2 black internal SATA ports (up to 3Gb/s supported per port).
Esc Exit ← Select Menu Enter Select ► Sub-Menu F10 Save and Exits	

Feature	Options	Description
Chipset SATA	Enable Disable	Enables or Disables the Chipset SATA Controller. The Chipset SATA controller supports the 2 internal SATA ports (up to 3Gb/s supported per port)
SATA Test Mode	Disable Enable	Enables or Disables the SATA Test Mode
Chipset SATA Mode	IDE AHCI	IDE: compatibility mode, disables AHCI. AHCI: supports advanced SATA features such as NCQ. Warning: do not change after OS install
SATA Port 0 Hot Plug Capability	Enable Disable	If enabled, SATA port will be reported as HotPlug capable
SATA Port 1 Hot Plug Capability	Enable Disable	If enabled, SATA port will be reported as HotPlug capable

LPSS & SCC Configuration

Phoenix SecureCore Technology Setup		
Advanced		
LPSS & SCC Configuration	Item Specific Help	
LPSS & SCC Devices Mode	[PCI Mode]	LPSS & SCC Devices Mode Settings
SCC Configuration		
SCC eMMC Boot Controller	[Auto Detect]	
eMMC 4.5 Support	[Enable]	
eMMC DDR50 Support	[Disable]	
eMMC HS200 Support	[Disable]	
eMMC retune timer value	[8]	
SCC SD Card Support	[Enable]	
SD SDR 25 Support	[Enable]	
SD SDR 50 Support	[Enable]	
Esc Exit ← Select Menu Enter Select ► Sub-Menu F10 Save and Exits		

Feature	Options	Description
LPSS & SCC Devices Mode	ACPI Mode PCI Mode	Select operation mode for Low Power Super Speed LPSS devices eMMC/SDCard. For eMMC full speed operation the LPSS mode should be set to "ACPI"
SCC eMMC Boot Controller	Disable Auto Detect eMMC 4.41 eMMC 4.5	Disable or select eMMC Boot mode
eMMC 4.5 support	Disable Enable	Enabled: eMMC 4.5, Disabled: eMMC 4.41
eMMC DDR50 Support	Disable Enable	Enable / Disable DDR50 speed mode for eMMC
eMMC HS200 Support	Disable Enable	Enable / Disable HS200 speed mode for eMMC. For eMMC full speed operation the HS200 mode should be enabled.
- eMMC retune timer value	8	Select the retune timer in HS200 mode
SCC SD Card Support	Disable Enable	Enable/Disable onboard SD Card socket
SD SDR 25 Support	Disable Enable	Enable bus speed operation up to 25MB/s for SDCard (High Speed). Disable limits bus speed to 12.5MB/s (normal speed)
SD SDR 50 Support	Disable Enable	Enable bus speed operation up to 50MB/s for SDCard (Ultra High Speed). Disabled activates SDR25 mode setting

Miscellaneous Configuration

Phoenix SecureCore Technology Setup		
Advanced		
Miscellaneous Configuration		Item Specific Help
Miscellaneous Configuration		Enable or Disable the High Precision Event Timer
High Precision Timer	[Enable]	
Boot Time with HPET Timer	[Disable]	
State After G3	[S0 State]	
SMM LOCK	[Enable]	
Pci Mmio Size	[2GB]	

Esc Exit ← Select Menu Enter Select ► Sub-Menu F10 Save and Exits

Feature	Options	Description
High Precision Timer	Disable Enable	Enables or Disables the High Precision Event Timer
Boot Time with HPET Timer	Disable Enable	Boot time calculation with High Precision Event Timer enabled
State After G3	S0 State S5 State	Specify what state to go to when power is re-applied after a power failure (G3 state). S0 = Power on, S5 = Stay off
SMM LOCK	Disable Enable	Enables or Disables the SMM Lock feature. It will lock the SMRAM and unable load SMM driver any more
Pci Mmio Size	2GB 1.5GB 1.25GB 1GB	Select PCI MMIO Size

SMBIOS Event Log

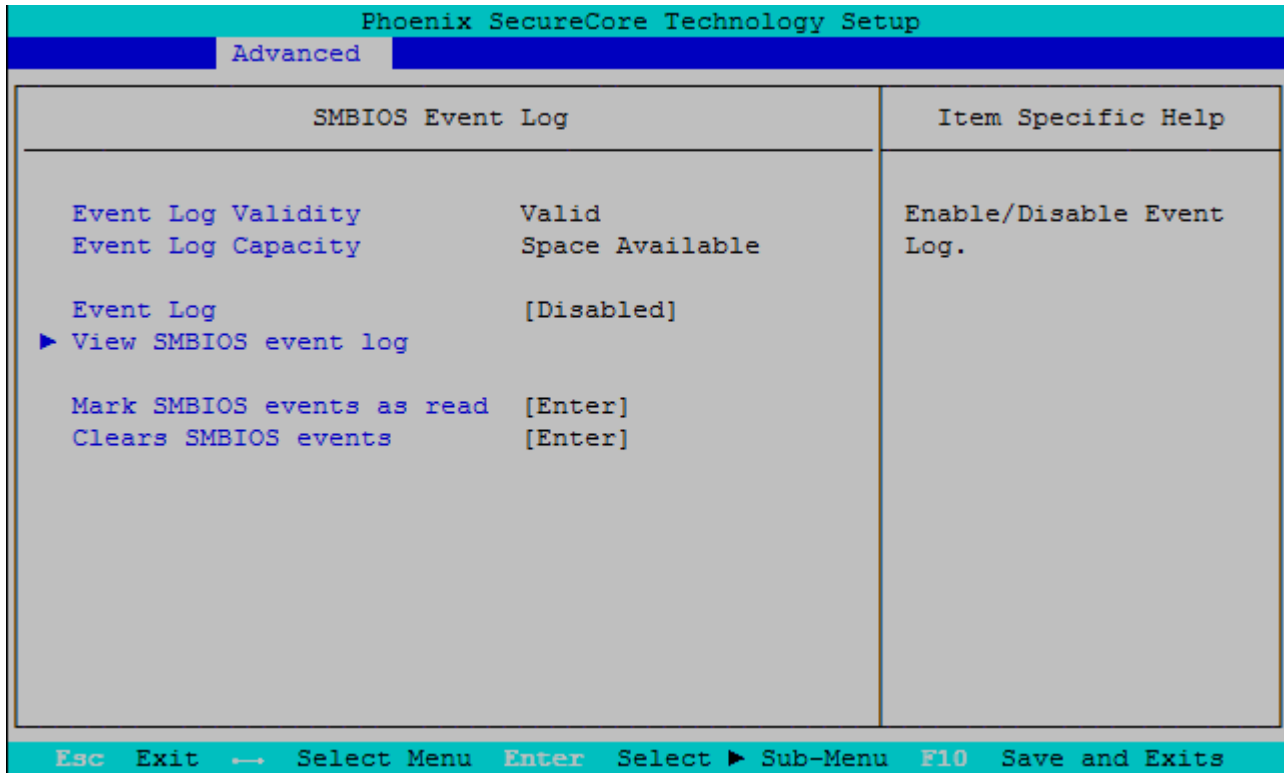

Feature	Options	Description
Event Log	Disable Enable	Enables or Disables the SMBIOS Event Log
Mark SMBIOS events as read	Enter	Mark SMBIOS events as read. Marked SMBIOS events won't be displayed
Clears SMBIOS events	Enter	Clear SMBIOS events

View SMBIOS event log

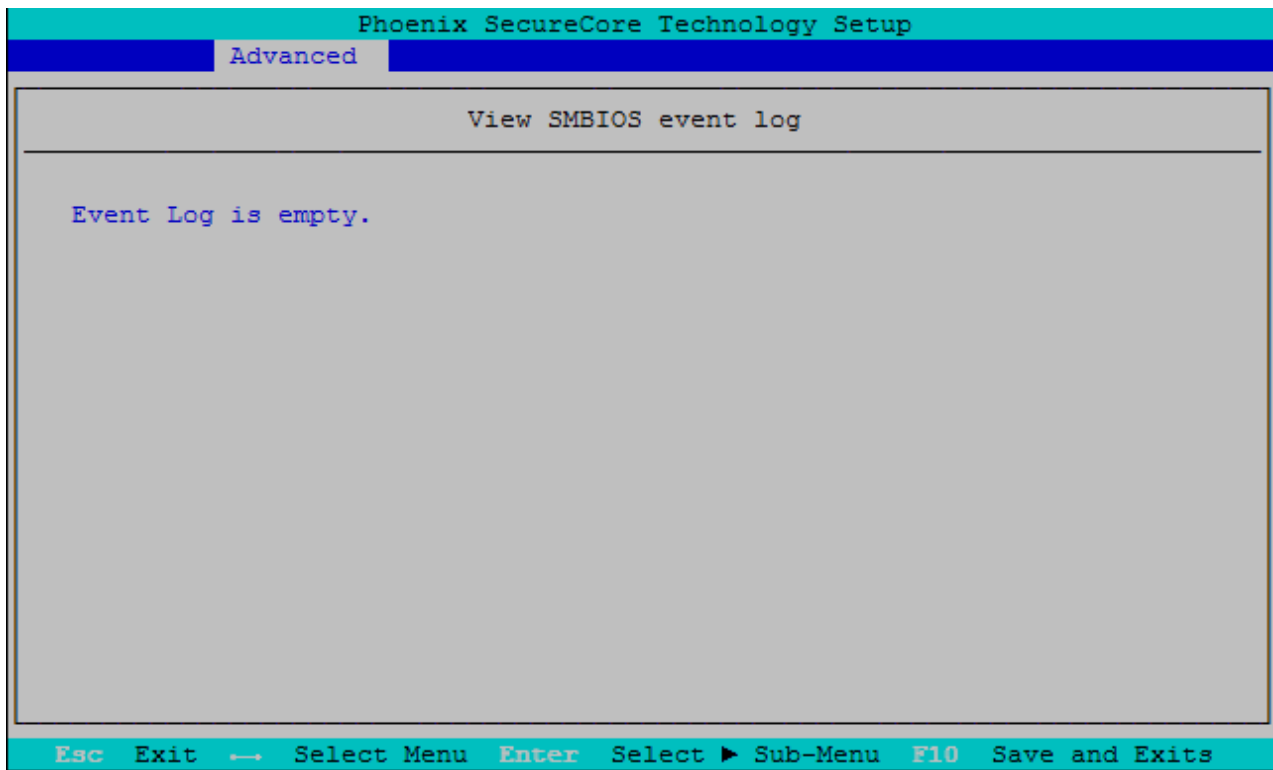

SuperIO Configuration

This setup option is only available with LPC SuperI/O Nuvoton 83627 present on the carrier board. By default the COMe-cBT6 supports the legacy interfaces of a 5V 83627HF(J) or 3.3V 83627DHG-P on external LPC. The SIO hardware monitor is not supported in setup.

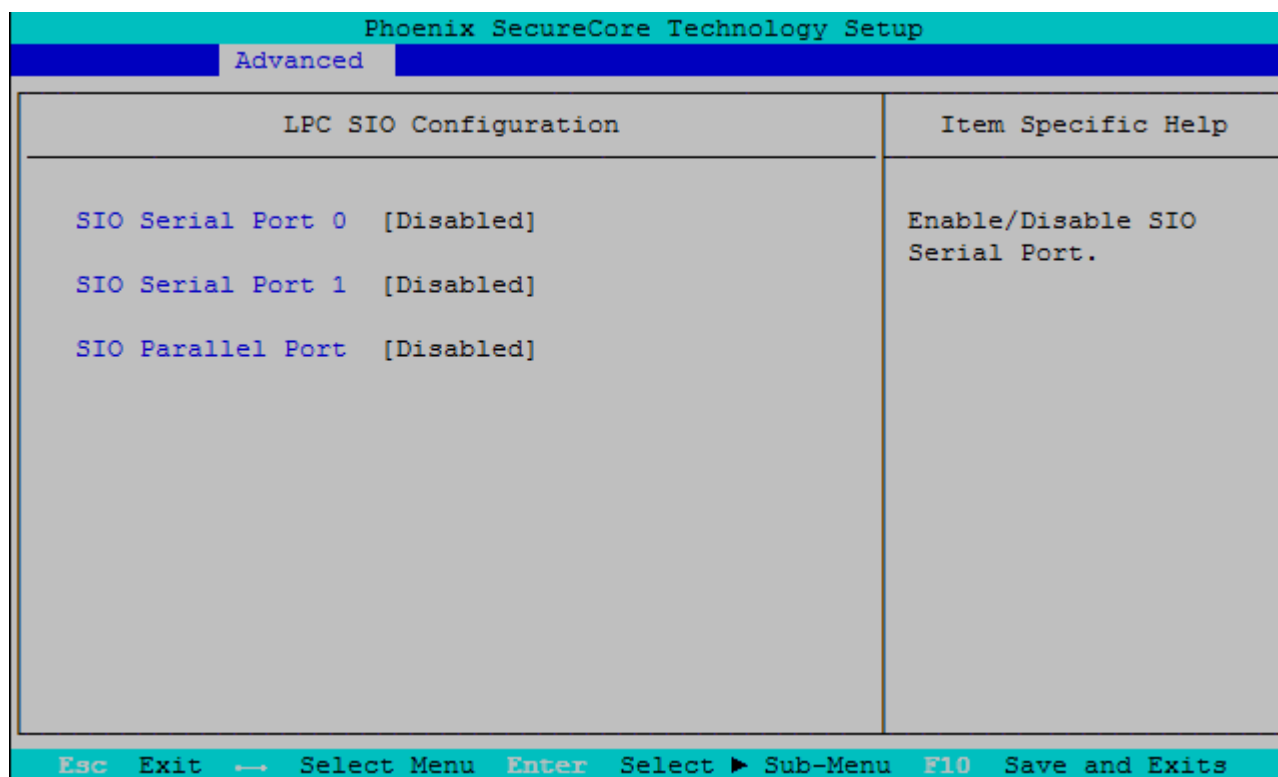

Feature	Options	Description
SIO Serial Port 0	Disabled Enabled	Enable or Disable SIO Serial Port
- Base Address	3F8 2F8 3E8 2E8	Configure Serial Port Base Address
- IRQ	3 4 5 6 7 12	Configure Serial Port IRQ
SIO Serial Port 1	Disabled Enabled	Enable or Disable SIO Serial Port
- Base Address	3F8 2F8 3E8 2E8	Configure Serial Port Base Address
- IRQ	3 4 5 6 7 12	Configure Serial Port IRQ
SIO Parallel Port	Disabled Enabled	Enable or Disable SIO Parallel Port
- Device Mode	Standard Parallel Port EPP EPP & ECP	Configure Parallel Port Mode
- Base Address	378 278 3BC	Configure Parallel Port Base Address

Onboard UART Configuration

Phoenix SecureCore Technology Setup	
Advanced	
Onboard UART configuration	Item Specific Help
Serial Port 0 [Enabled] Base Address [3F8] IRQ [4]	Enable/Disable Serial Port.
Serial Port 1 [Enabled] Base Address [2F8] IRQ [3]	
Esc Exit ← Select Menu Enter Select ► Sub-Menu F10 Save and Exits	

Feature	Options	Description
Serial Port 0	Disabled Enabled	Enable or Disable Serial Port (COM) 0
Base Address	3F8 2F8 3E8 2E8	Configure Serial Port Base Address
IRQ	3 4 5 6 7 12	Configure Serial Port IRQ
Serial Port 1	Disabled Enabled	Enable or Disable Serial Port (COM) 1
Base Address	3F8 2F8 3E8 2E8	Configure Serial Port Base Address
IRQ	3 4 5 6 7 12	Configure Serial Port IRQ

7.5.3. Security

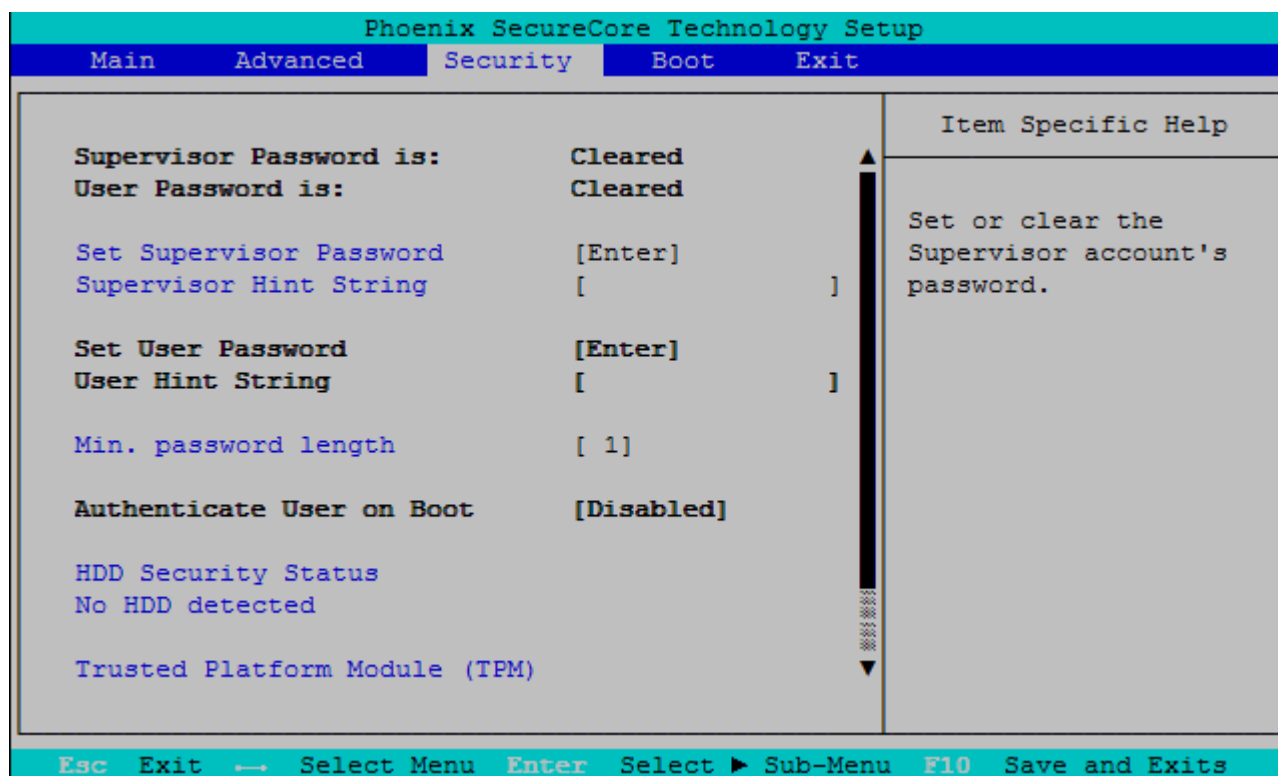

Feature	Options	Description
Set Supervisor Password	Enter	Set or clear the Supervisor account's password
Supervisor Hint String	-	Press Enter to type Supervisor Hint String
Min. password length	1	Set the minimum number of characters for password (1-20)
TPM Support	Disabled Enabled	This is used to decide whether TPM support should be enabled or disabled

TPM Options

Feature	Options	Description
TPM Action	No Change Enable Disable Activate Deactivate Clear Enable and Activate Disable and Deactivate Set Owner Install, with state=True Set Owner Install, with state=False Enable, Activate, and Set Owner Install with state=True Disable, Deactivate, and Set Owner Install with state=False Clear, Enable, and Activate Require PP for provisioning Do not require PP for provisioning Require PP for clear Do not require PP for clear Enable, Activate, and clear Enable, Activate, Clear, Enable, and Activate	Enact TPM Action
Omit Boot Measurements	Disabled Enabled	Enabling this option causes the system to omit recording boot device attempts in PCR[4]

7.5.4. Boot

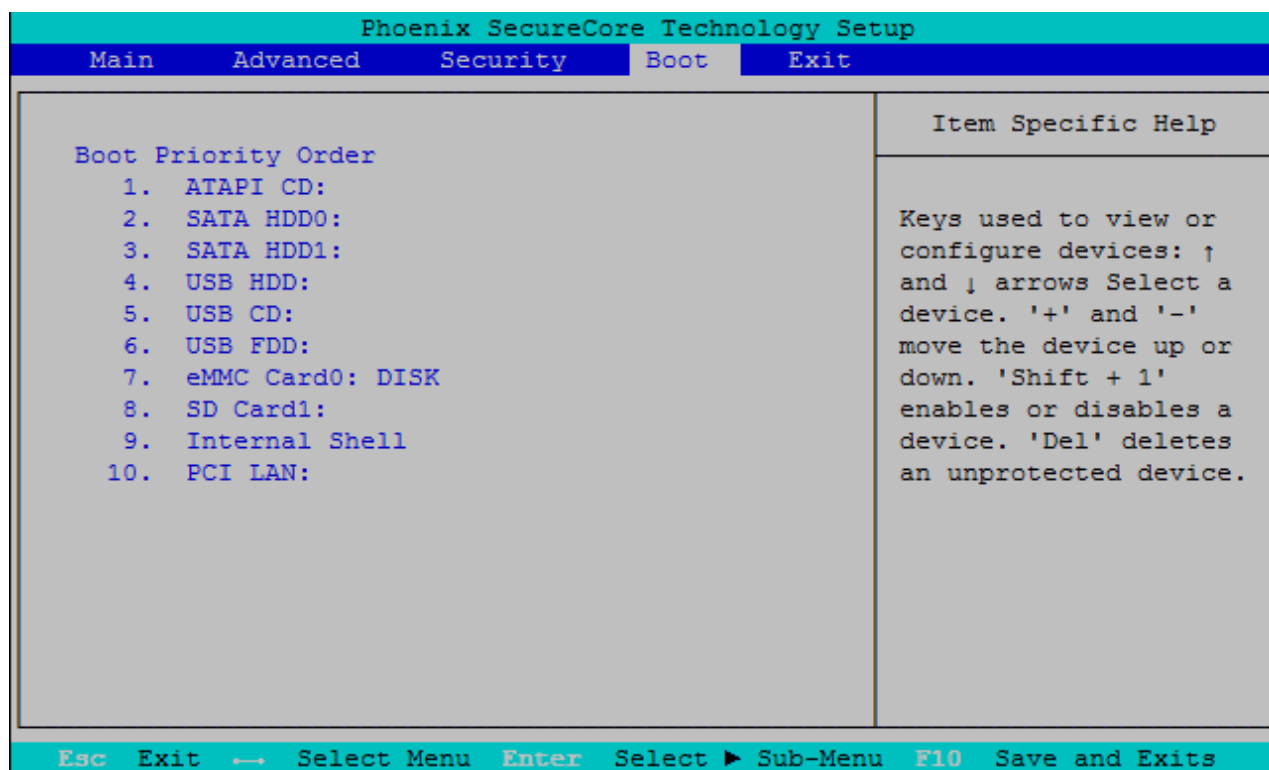

7.5.5. Exit

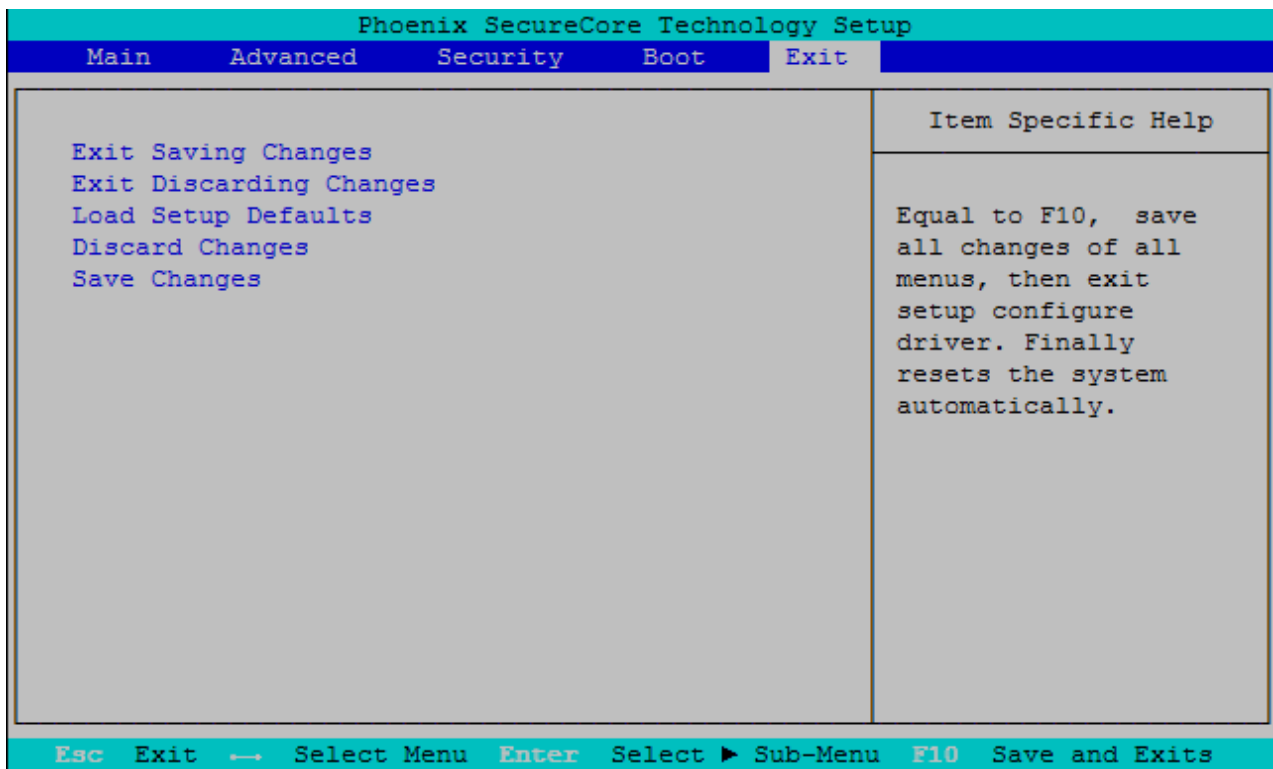



About Kontron

Kontron is a global leader in Embedded Computing Technology (ECT). As a part of technology group S&T, Kontron offers a combined portfolio of secure hardware, middleware and services for Internet of Things (IoT) and Industry 4.0 applications. With its standard products and tailor-made solutions based on highly reliable state-of-the-art embedded technologies, Kontron provides secure and innovative applications for a variety of industries. As a result, customers benefit from accelerated time-to-market, reduced total cost of ownership, product longevity and the best fully integrated applications overall. For more information, please visit: www.kontron.com

Global Headquarters

Kontron S&T AG
Lise-Meitner-Str. 3-5
86156 Augsburg
Germany
Tel.: + 49 821 4086-0
Fax: + 49 821 4086-111
info@kontron.com

