



KBox B-203-RPL

Preliminary User Guide Rev. 0.2

Doc. ID 1075-0133

This page has been intentionally left blank

KBox B-203-RPL – User Guide

Disclaimer

Kontron would like to point out that the information contained in this user guide may be subject to alteration, particularly as a result of the constant upgrading of Kontron products. This document does not entail any guarantee on the part of Kontron with respect to technical processes described in the user guide or any product characteristics set out in the user guide. Kontron assumes no responsibility or liability for the use of the described product(s), conveys no license or title under any patent, copyright or mask work rights to these products and makes no representations or warranties that these products are free from patent, copyright or mask work right infringement unless otherwise specified. Applications that are described in this user guide are for illustration purposes only. Kontron makes no representation or warranty that such application will be suitable for the specified use without further testing or modification. Kontron expressly informs the user that this user guide only contains a general description of processes and instructions which may not be applicable in every individual case. In cases of doubt, please contact Kontron.

This user guide is protected by copyright. All rights are reserved by Kontron. No part of this document may be reproduced, transmitted, transcribed, stored in a retrieval system, or translated into any language or computer language, in any form or by any means (electronic, mechanical, photocopying, recording, or otherwise), without the express written permission of Kontron. Kontron points out that the information contained in this user guide is constantly being updated in line with the technical alterations and improvements made by Kontron to the products and thus this user guide only reflects the technical status of the products by Kontron at the time of publishing.

Brand and product names are trademarks or registered trademarks of their respective owners.

©2024 by Kontron Europe GmbH

Kontron Europe GmbH
Gutenbergstraße 2
85737 Ismaning
Germany
www.kontron.com

Intended Use

This device and associated software are not designed, manufactured or intended for use or resale for the operation of nuclear facilities, the navigation, control or communication systems for aircraft or other transportation, air traffic control, life support or life sustaining applications, weapons systems, or any other application in a hazardous environment, or requiring fail-safe performance, or in which the failure of products could lead directly to death, personal injury, or severe physical or environmental damage (collectively, “high risk applications”).

You understand and agree that your use of Kontron devices as a component in High Risk Applications is entirely at your risk. To minimize the risks associated with your products and applications, you should provide adequate design and operating safeguards. You are solely responsible for compliance with all legal, regulatory, safety, and security related requirements concerning your products. You are responsible to ensure that your systems (and any Kontron hardware or software components incorporated in your systems) meet all applicable requirements. Unless otherwise stated in the product documentation, the Kontron device is not provided with error-tolerance capabilities and cannot therefore be deemed as being engineered, manufactured or setup to be compliant for implementation or for resale as device in High Risk Applications. All application and safety related information in this document (including application descriptions, suggested safety measures, suggested Kontron products, and other materials) is provided for reference only.

NOTICE

You find the most recent version of the “General Safety Instructions” online in the download area of this product.

NOTICE

This product is not intended for use or suited for storage or operation in corrosive environments, in particular under exposure to sulfur and chlorine and their compounds. For information on how to harden electronics and mechanics against these stress conditions, contact Kontron Support.

Revision History

Revision	Brief Description of Changes	Date of Issue	Author
0.1	Initial hardware information	27-Jan 2025	CW
0.2	No PE use potential equalization, removed holdup table, updated RAID and power connector information, aligned with KBox B 204 and new block diagram	21-Feb-2025	CW

Terms and Conditions

Kontron warrants products in accordance with defined regional warranty periods. For more information about warranty compliance and conformity, and the warranty period in your region, visit www.kontron.com/terms-and-conditions.

Kontron sells products worldwide and declares regional General Terms & Conditions of Sale, and Purchase Order Terms & Conditions. Visit www.kontron.com/terms-and-conditions.

For contact information, refer to the corporate offices contact information on the last page of this user guide or visit our website [CONTACT US](#).

Customer Support

Find Kontron contacts by visiting www.kontron.com/support-and-services.

Customer Service

As a trusted technology innovator and global solutions provider, Kontron extends its embedded market strengths into a services portfolio allowing companies to break the barriers of traditional product lifecycles. Proven product expertise coupled with collaborative and highly-experienced support enables Kontron to provide exceptional peace of mind to build and maintain successful products.

For more details on Kontron's service offerings such as: enhanced repair services, extended warranty, Kontron training academy, and more visit www.kontron.com/support-and-services.

Customer Comments

If you have any difficulties using this user guide, discover an error, or just want to provide some feedback, contact [Kontron support](#). Detail any errors you find. We will correct the errors or problems as soon as possible and post the revised user guide on our website.

Symbols

The following symbols may be used in this user guide



DANGER indicates a hazardous situation which, if not avoided, will result in death or serious injury.



WARNING indicates a hazardous situation which, if not avoided, could result in death or serious injury.



NOTICE indicates a property damage message.



CAUTION indicates a hazardous situation which, if not avoided, may result in minor or moderate injury

ATTENTION indique une situation dangereuse qui, si elle n'est pas évitée, peut entraîner des blessures mineures ou modérées.



Electric Shock!

This symbol and title warn of hazards due to electrical shocks (> 60 V) when touching products or parts of products. Failure to observe the precautions indicated and/or prescribed by the law may endanger your life/health and/or result in damage to your material.



ESD Sensitive Device!

This symbol and title inform that the electronic boards and their components are sensitive to static electricity. Care must therefore be taken during all handling operations and inspections of this product in order to ensure product integrity at all times.



Caution: HOT Surface!

Do NOT touch! Allow to cool before servicing.

Attention : Surface CHAUDE !

Ne pas toucher ! Laissez refroidir avant de procéder à l'entretien.



Caution: Laser!

This symbol inform of the risk of exposure to laser beam and light emitting devices (LEDs) from an electrical device. Eye protection per manufacturer notice shall review before servicing.



High sound pressure!

High sound pressure possible with headphones. There is a risk of hearing damage. Do not listen at high volume levels for long periods of time.



Security

This symbol indicates general information and guidelines regarding security/cyber security to ensure installation, operation, maintenance and disposal of the product meet the required guidelines within the user's end environment.



This symbol indicates general information about the product and the user guide.
This symbol also indicates detail information about the specific product configuration.



This symbol precedes helpful hints and tips for daily use.

For Your Safety

Your new Kontron product was developed and tested carefully to provide all features necessary to ensure its compliance with electrical safety requirements. It was also designed for a long fault-free life. However, the life expectancy of your product can be drastically reduced by improper treatment during unpacking and installation. Therefore, in the interest of your own safety and of the correct operation of your new Kontron product, you are requested to conform with the following guidelines.

High Voltage Safety Instructions

As a precaution and in case of danger, the power connector must be easily accessible. The power connector is the product's main disconnect device.

⚠ CAUTION

Warning

All operations on this product must be carried out by sufficiently skilled personnel only.

⚠ CAUTION



Electric Shock!

Before installing a non hot-swappable Kontron product into a system always ensure that your mains power is switched off. This also applies to the installation of piggybacks. Serious electrical shock hazards can exist during all installation, repair, and maintenance operations on this product. Therefore, always unplug the power cable and any other cables which provide external voltages before performing any work on this product.

Earth ground connection to vehicle's chassis or a central grounding point shall remain connected. The earth ground cable shall be the last cable to be disconnected or the first cable to be connected when performing installation or removal procedures on this product.

Special Handling and Unpacking Instruction

NOTICE



ESD Sensitive Device!

Electronic boards and their components are sensitive to static electricity. Therefore, care must be taken during all handling operations and inspections of this product, in order to ensure product integrity at all times.

⚠ CAUTION

Handling and operation of the product is permitted only for trained personnel within a work place that is access controlled. Follow the "General Safety Instructions" supplied with the product.

Do not handle this product out of its protective enclosure while it is not used for operational purposes unless it is otherwise protected.

Whenever possible, unpack or pack this product only at EOS/ESD safe work stations. Where a safe work station is not guaranteed, it is important for the user to be electrically discharged before touching the product with his/her hands or tools. This is most easily done by touching a metal part of your system housing.

It is particularly important to observe standard anti-static precautions when changing piggybacks, ROM devices, jumper settings etc. If the product contains batteries for RTC or memory backup, ensure that the product is not placed on conductive surfaces, including anti-static plastics or sponges. They can cause short circuits and damage the batteries or conductive circuits on the product.

Lithium Battery Precautions

If your product is equipped with a lithium battery, take the following precautions when replacing the lithium battery.

⚠ CAUTION

Risk of Explosion if the lithium Battery is replaced by an incorrect Type. Dispose of used lithium batteries according to the instructions.

Risque d'explosion si la pile au lithium est remplacée par une pile de type incorrect.
Éliminez les piles au lithium usagées conformément aux instructions.

General Instructions on Usage

In order to maintain Kontron's product warranty, this product must not be altered or modified in any way. Changes or modifications to the product, that are not explicitly approved by Kontron and described in this user guide or received from Kontron Support as a special handling instruction, will void your warranty.

This product should only be installed in or connected to systems that fulfill all necessary technical and specific environmental requirements. This also applies to the operational temperature range of the specific board version that must not be exceeded. If batteries are present, their temperature restrictions must be taken into account.

In performing all necessary installation and application operations, only follow the instructions supplied by the present user guide.

Keep all the original packaging material for future storage or warranty shipments. If it is necessary to store or ship the product then re-pack it in the same manner as it was delivered.

Special care is necessary when handling or unpacking the product. See Special Handling and Unpacking Instruction.

Quality and Environmental Management

Kontron aims to deliver reliable high-end products designed and built for quality, and aims to complying with environmental laws, regulations, and other environmentally oriented requirements. For more information regarding Kontron's quality and environmental responsibilities, visit www.kontron.com/about-kontron/corporate-responsibility/quality-management.

Table of Contents

Revision History.....	5
Symbols	6
For Your Safety.....	8
High Voltage Safety Instructions	8
Special Handling and Unpacking Instruction	8
Lithium Battery Precautions	9
General Instructions on Usage	9
Quality and Environmental Management	9
Table of Contents	10
List of Tables.....	12
List of Figures	12
1/ Introduction.....	14
2/ General Safety Instructions	16
2.1. Additional Safety Instructions for DC Power Supply Circuits	17
2.2. Instructions générales de sécurité	17
2.3. Electrostatic Discharge (ESD).....	18
2.4. Grounding Methods	19
2.5. Instructions for Lithium Battery	19
3/ Shipment and Unpacking	20
3.1. Packaging.....	20
3.2. Unpacking.....	20
3.3. Scope of Delivery.....	20
3.4. Accessories and Spare Parts	21
3.5. Type Label and Product Identification.....	22
4/ Product Features	23
4.1. Front Panel	23
4.1.1. Power Button (POWER)	23
4.1.2. USB 3.2 Gen 1 Ports (USB 3.0)	23
4.2. Rear Panel.....	24
4.2.1. Power Connector	24
4.2.2. Potential Equalization Stud.....	25
4.2.3. Kensington Lock.....	25
4.2.4. Interface Panel.....	26
4.3. Left and Right Side.....	29
4.4. Top Cover and Bottom Sides	30
5/ System Expansion.....	31
5.1. Before Expanding	31
5.2. Internal M.2 Sockets.....	31
5.2.1. Wi-Fi/BT® (option)	31
5.2.2. Storage (option).....	32
5.3. Reference Expansion Devices.....	32
6/ Thermal Management.....	34
6.1. Active Cooling.....	34
6.2. Mount Orientation	34
6.3. Minimum Clearance (Keep out Area)	35
6.4. Third Party Components.....	35
7/ Assembly	36
7.1. Before Assembling.....	36
7.2. Opening the Product	36
7.2.1. Installing and Removing an M.2 Wi-Fi/BT® Module	37
7.2.2. Installing and Removing an M.2 SSD Module	38
8/ Installation.....	41
8.1. Before Installing	41
8.2. Chassis Feet	42
8.3. Wall Mount.....	42

8.4. VESA 100 Mount Assembly Kit	44
8.4.1. Mounting Directly on a Monitor	46
8.4.2. Mounting using the Monitor's VESA 100 Stand	47
9/ Starting Up.....	48
9.1. Before Starting	48
9.2. Connecting to the Power Connector	49
9.2.1. 12 VDC DC IN (150 W) Power Jack.....	49
9.2.2. 24 VDC DC IN 3-pin Power Connector (option)	50
9.3. Switching On/Off.....	52
9.4. Forced Shutdown	52
9.5. Operating System (OS) and Hardware Component Drivers	52
10/ BIOS	53
10.1. Starting the uEFI BIOS.....	53
10.2. BIOS Setup Menus	53
10.3. BIOS Navigation	54
10.4. Updating the BIOS	54
10.5. Recover BIOS	55
11/ RAID	56
12/ Product Specifications	57
12.1. Block Diagrams	57
12.2. Hardware Specification	58
12.3. Software Specification.....	58
12.4. Power Specification	59
12.4.1. 12 VDC DC IN Electrical Specification	59
12.4.2. 24 VDC DC IN Electrical Specification (option)	59
12.4.3. Power Protection.....	60
12.4.4. Power Consumption	60
12.4.5. Potential Equalization.....	60
12.5. Environmental Specification.....	61
12.6. Mechanical Specification.....	61
12.6.1. Dimension Diagrams KBox B-203-RPL	62
12.6.2. Dimension Diagrams Wall Mount.....	63
12.6.3. Dimension Diagrams VESA 100 Mount.....	63
12.7. Compliance.....	64
13/ Connectors and LEDs.....	67
13.1. 12 VDC DC IN Power Jack Pin Assignment (default).....	67
13.2. 24 VDC DC IN 3-Pin Connector Pin Assignment (option).....	67
13.3. USB 3.2 Gen 2/1 Port Pin Assignment	68
13.4. USB-C 3.2 Gen 2 Port Pin Assignment	68
13.5. USB 2.0 Pin Assignment.....	68
13.6. Display Port (DP) V1.4a Pin Assignment.....	69
13.7. LAN 2.5 GbE/1 GbE Connector Pin Assignment.....	69
13.8. Audio (Line-In & Line-Out) Connector Pin Assignment	69
13.9. COM Port Pin Assignment (option)	70
13.10. Antenna Wi-Fi/BT® Pin Assignment	70
13.11. S/PDIF Pin Assignment (option)	70
14/ Maintenance	71
14.1. Cleaning the Product	71
14.2. Replacing Lithium Battery	71
14.3. BIOS Recovery Jumper.....	72
15/ Storage and Transportation	73
15.1. Storage	73
15.2. Transportation.....	73
16/ Technical Support.....	74
16.1. Returning Defective Merchandise.....	74
17/ Warranty	75
18/ Disposal	76

18.1. Disposal	76
18.2. WEEE Compliance.....	76
18.3. Data Sanitation	76
18.4. Statement of Memory Volatility.....	78
19/ Cyber Security	79
19.1. Security Defense Strategy	79
Appendix: List of Acronyms.....	80

List of Tables

Table 1: Scope of Delivery	20
Table 2: List of Accessories and Spare Parts	21
Table 3: Display Resolution	27
Table 4: Display Order Priority Chain	27
Table 5: Wi-Fi/BT® Option.....	31
Table 6: Storage Option	32
Table 7: Reference Expansion Devices	32
Table 8: Navigation Hot Keys Available in the Legend Bar.....	54
Table 9: Configuration Jumper Pin Assignment	55
Table 10: RAID Options	56
Table 11: Hardware Specification	58
Table 12: Software Specification	58
Table 13: 12 VDC DC IN Power Jack Electrical Specification	59
Table 14: 24 VDC DC IN Electrical Specification (option)	59
Table 15: Power Consumption Estimation.....	60
Table 16: Environmental Specification.....	61
Table 17: Mechanical Specification.....	61
Table 18: Compliance CE	64
Table 19: Compliance CE RED and United Kingdom.....	64
Table 20: Compliance International	65
Table 21: 12 VDC DC IN Power Jack Pin Assignment.....	67
Table 22: 24 VDC DC IN 3-pin Connector Pin Assignment.....	67
Table 23: USB 3.1 Gen 2/1 Port (Type-A) Pin Assignment	68
Table 24: USB-C 3.2 Gen 2 Port Pin Assignment	68
Table 25: USB 2.0 Port (Type-A) Pin Assignment	68
Table 26: Display Port (DP) Connector Pin Assignment	69
Table 27: LAN (2.5 GbE/1 GbE) Connector Pin Assignment	69
Table 28: Audio (Line-In & Line-Out) Pin Assignment	69
Table 29: COM (RS232) Connector Pin Assignment	70
Table 30: Antenna Wi-Fi/BT®	70
Table 31: Battery Header	72
Table 32: CR2032 Lithium Battery with Connector	72
Table 33: Statement of Memory Volatility (Example).....	78

List of Figures

Figure 1: KBox B-203 RPL.....	14
Figure 2: Type Label Example	22
Figure 3: Front Panel	23

Figure 4: Rear Panel	24
Figure 5: Interface Panel	26
Figure 6: Left and Right Sides	29
Figure 7: Top Cover	30
Figure 8: Bottom Side	30
Figure 9: M.2 Sockets (stacked)	31
Figure 10: Ventilation Openings	34
Figure 11: M.2 Wi-Fi/BT® Socket	37
Figure 12: M.2 2280 NVMe SSD Sockets	39
Figure 13: Wall Mount Bracket	42
Figure 14: Wall Mount Bracket Orientation	43
Figure 15: VESA 100 Mount Assembly	44
Figure 16: KBox B-203-RPL Mounting Position	44
Figure 17: Inserting the Velcro® Band	45
Figure 18: Positioning the Power Supply	45
Figure 19: Direct Mounting on a Monitor	46
Figure 20: Mounting with a VESA Stand on the Monitor	47
Figure 21: Power Connectors	49
Figure 22: External AC/DC, (150 W) Power Supply	49
Figure 23: 3-pin Mating Power Connector	50
Figure 24: BIOS FTP Server Example	54
Figure 25: Configuration Jumper Header	55
Figure 26: Block Diagram KBox B-203-RPL	57
Figure 27: KBox B-203-RPL Dimensions	62
Figure 28: Wall Mount Dimensions (mm)	63
Figure 29: VESA 100 Mount Dimensions (mm)	63
Figure 30: CR2032 Lithium Battery and BAT header	72

1/Introduction

This user guide describes the KBox B-203 RPL, part of the KBox B industrial Box PC series also known as product within this user guide. This user guide focuses on describing the product's special features and how to assemble, install, operate, maintain and dispose of the product properly. New users are recommended to study the instructions within this user guide before switching on the product.

Figure 1: KBox B-203 RPL



At the heart of the KBox B-203-RPL is the Kontron mITX motherboard K3836-Q, designed and manufactured in Germany that supports 14th Generation Intel® Core™ i3/i5/i7/i9 and Intel® Desktop 300T Processors. The motherboard is equipped with the Intel® Q670E chipset and offers two SODIMM sockets for high-performance DDR5 system memory with up to 96 GBytes and storage with up to two fast SSDs supporting RAID.

With product ensures high data throughput and connectivity with one 2.5 GbE port, one 1 GbE, up to two COM ports, ten USB ports (including one USB-C) and optional fast wireless connection with Wi-Fi and Bluetooth®. The four Display Ports enable the connection of up to four simultaneous displays. The product is power by an AC/DC (150 W) power supply provided by Kontron in the delivery or optionally a 24 VDC power variant for direct connection to an external 24 VDC power supply.

The product's compact design supports the thermal concept with a low noise level 'Whisper Quiet Operation' 34 dB(A) maximum to ensures smooth operation at temperatures up to +45°C and thus permanent, high-availability use around the clock. The product's flexible mounting options support desktop and wall mounting with attachable brackets.

General features overview:

Motherboard

- › mITX K3836-Q

Processors

- › Intel Core™ Processors series i9/i7/i5/i3 14th Generation
- › Intel® Desktop 300T

Chipset

- › Intel® Q670E

System Memory

- › 2x SODIMM sockets for DDR5 up to 96 GB

Rear Interfaces:

- › 4x DP
- › 3x USB 3.2 Gen 2
- › 1x USB-C 3.2 Gen 2

- › 4x USB 2.0
- › 1x 2.5 GbE
- › 1x 1 GbE
- › 1x Audio (Line-In, Line-Out)
- › 1x COM RS232 (option)
- › 1x Breakout panel (COM RS232 or SPDIF option)

Front Interfaces:

- › 2x USB 3.2 Gen 1

System Expansion

- › Wi-Fi 6E/Bluetooth (option)
- › Storage (2x M.2 2280 NVMe SSD with RAID support) (option)

Software

- › Windows 11
- › Linux (Debian)

DC IN Power

- › 12 VDC (AC/DC PSU, 150 W)
- › 24 VDC (160 W) (option)

Installation

- › Desktop
- › Wall mount
- › VESA 100 Mount

2/General Safety Instructions

Please read this passage carefully and take careful note of the instructions, which have been compiled for your safety and to ensure to apply in accordance with intended regulations. If the following general safety instructions are not observed, it could lead to injuries to the operator and/or damage of the product; in cases of non-observance of the instructions Kontron Europe is exempt from accident liability, this also applies during the warranty period.

The product has been built and tested according to the basic safety requirements for low voltage (LVD) applications and has left the manufacturer in safety-related, flawless condition. To maintain this condition and to also ensure safe operation, the operator must not only observe the correct operating conditions for the product but also the following general safety instructions:

- The product must be used as specified in the product documentation, in which the instructions for safety for the product and for the operator are described. These contain guidelines for setting up, installation and assembly, maintenance, transport or storage.
- The on-site electrical installation must meet the requirements of the country's specific local regulations.
- If a power cable comes with the product, only this cable should be used. Do not use an extension cable to connect the product.
- To guarantee that sufficient air circulation is available to cool the product, please ensure that the ventilation openings are not covered or blocked. If a filter mat is provided, this should be cleaned regularly. Do not place the product close to heat sources or damp places. Make sure the product is well ventilated.
- Only connect the product to an external power supply providing the voltage type (AC or DC) and the input power (max. current) specified on the Kontron Product Label and meeting the requirements of the Limited Power Source (LPS) and Power Source (PS2) of UL/IEC 62368-1 .
- Only products or parts that meet the requirements for Power Source (PS1) of UL/IEC 62368-1 may be connected to the product's available interfaces (I/O).
- Before opening the product, make sure that the product is disconnected from the mains.
- Switching off the product by its power button does not disconnect it from the mains. Complete disconnection is only possible if the power cable is removed from the wall plug or from the product. Ensure that there is free and easy access to enable disconnection.
- The product may only be opened for the insertion or removal of add-on cards (depending on the configuration of the product). This may only be carried out by qualified operators.
- If extensions are being carried out, the following must be observed:
 - all effective legal regulations and all technical data are adhered to
 - the power consumption of any add-on card does not exceed the specified limitations
 - the current consumption of the product does not exceed the value stated on the product label
- Only original accessories that have been approved by Kontron Europe can be used.
- Please note: safe operation is no longer possible when any of the following applies:
 - the product has visible damages or
 - the product is no longer functioning
 In this case the product must be switched off and it must be ensured that the product can no longer be operated.
- Handling and operation of the product is permitted only for trained personnel within a work place that is access controlled.
- CAUTION: Risk of explosion if the lithium battery is replaced incorrectly (short-circuited, reverse-poled, wrong lithium battery type). Dispose of used lithium batteries according to the manufacturer's instructions.
- This product is not suitable for use in locations where children are likely to be present

2.1. Additional Safety Instructions for DC Power Supply Circuits

- › To guarantee safe operation, please observe that:
 - › the external DC power supply must meet the criteria for LPS and PS2 (UL/IEC 62368-1)
 - › no cables or parts without insulation in electrical circuits with dangerous voltage or power should be touched directly or indirectly
 - › a reliable functional earth connection is provided
 - › a suitable, easily accessible disconnecting device is used in the application (e.g. overcurrent protective device), if the product itself is not disconnectable
 - › a disconnect device, if provided in or as part of the product, shall disconnect both poles simultaneously
 - › interconnecting power circuits of different products cause no electrical hazards
- › A sufficient dimensioning of the power cable wires must be selected – according to the maximum electrical specifications on the product label – as stipulated by EN62368-1 or VDE0100 or EN60204 or UL61010-1 regulations.

For the General Safety Instruction in German or French, visit Kontron's product web page > Downloads > Manuals > General Safety Instructions.

2.2. Instructions générales de sécurité

Veillez lire attentivement ce passage et prendre bonne note des instructions, qui ont été compilées pour votre sécurité et pour assurer une application conforme aux réglementations prévues. Le non-respect des consignes de sécurité générales suivantes peut entraîner des blessures pour l'utilisateur et/ou des dommages pour le produit. En cas de non-respect des consignes, Kontron Europe est exonéré de la responsabilité en cas d'accident, ceci s'applique également pendant la période de garantie.

Le produit a été construit et testé conformément aux exigences de sécurité de base pour les applications basse tension (DBT) et a quitté le fabricant dans un état impeccable en matière de sécurité. Pour maintenir cet état et pour garantir également un fonctionnement sûr, l'opérateur doit non seulement respecter les conditions d'utilisation correctes du produit, mais aussi les consignes de sécurité générales suivantes :

- › Le produit doit être utilisé conformément à la documentation du produit, dans laquelle sont décrites les instructions de sécurité pour le produit et pour l'opérateur. Celles-ci contiennent des directives pour la mise en place, l'installation et le montage, la maintenance, le transport ou le stockage.
- › L'installation électrique sur place doit répondre aux exigences des réglementations locales spécifiques du pays.
- › Si un câble d'alimentation est fourni avec le produit, seul ce câble doit être utilisé. N'utilisez pas de rallonge pour connecter le produit.
- › Afin de garantir une circulation d'air suffisante pour refroidir le produit, veuillez vous assurer que les ouvertures de ventilation ne sont pas couvertes ou obstruées. Si un élément filtrant est fourni, celui-ci doit être nettoyé régulièrement. Ne placez pas le produit à proximité de sources de chaleur ou d'endroits humides. Veillez à ce que le produit soit bien ventilé.
- › Ne connectez le produit qu'à une alimentation externe fournissant le type de tension (AC ou DC) et la puissance d'entrée (courant max.) spécifiés sur le Label Produit Kontron et répondant aux exigences de la source d'alimentation limitée (LPS) et de la source d'alimentation (PS2) de la norme UL/IEC 62368-1.
- › Seuls les produits ou les pièces qui répondent aux exigences de la source d'alimentation (PS1) de la norme UL/IEC 62368-1 peuvent être connectés aux interfaces (E/S) disponibles du produit.
- › Avant d'ouvrir le produit, assurez-vous qu'il est bien débranché du secteur.
- › Le fait d'éteindre le produit par son bouton de mise en marche ne le déconnecte pas du secteur. Une déconnexion complète n'est possible que si le câble d'alimentation est retiré de la prise murale ou du produit. Veillez à ce que l'accès soit libre et facile pour permettre la déconnexion.
- › Le produit ne peut être ouvert que pour l'insertion ou le retrait de cartes supplémentaires (selon la configuration du produit). Cette opération ne peut être effectuée que par des opérateurs qualifiés.

- › Si des extensions sont effectuées, les points suivants doivent être respectés :
 - › toutes les réglementations légales en vigueur et toutes les données techniques sont respectées
 - › la consommation électrique d'une carte supplémentaire ne dépasse pas les limites spécifiées
 - › la consommation actuelle du produit ne dépasse pas la valeur indiquée sur l'étiquette du produit.
- › Seuls les accessoires d'origine approuvés par Kontron Europe peuvent être utilisés.
- › Veuillez noter que la sécurité des opérations n'est plus possible lorsque l'une des conditions suivantes s'applique.
 - › le produit présente des dommages visibles ou
 - › le produit ne fonctionne plus. Dans ce cas, le produit doit être éteint et il faut s'assurer que le produit ne puisse plus être utilisé.
- › La manipulation et le fonctionnement du produit ne sont autorisés que pour le personnel formé dans un lieu de travail dont l'accès est contrôlé.
- › ATTENTION: Risque d'explosion en cas de remplacement incorrect de la pile au lithium (court-circuit, inversion de polarité, mauvais type de pile au lithium). Éliminez les piles au lithium usagées conformément aux instructions du fabricant.
- › Ce produit n'est pas adapté à une utilisation dans des endroits où des enfants sont susceptibles d'être présents
- › Instructions de sécurité supplémentaires pour les circuits d'alimentation en courant continu
- › Pour garantir un fonctionnement sûr, veuillez observer ce qui suit:
 - › l'alimentation électrique externe en courant continu doit répondre aux critères des LPS et PS2 (UL/IEC 62368-1)
 - › aucun câble ou pièce non isolée dans les circuits électriques ayant une tension ou une puissance dangereuse ne doit être touché directement ou indirectement
 - › une connexion à la terre fonctionnelle fiable est fournie
 - › un dispositif de déconnexion approprié et facilement accessible est utilisé dans l'application (par exemple, un dispositif de protection contre les surintensités), si le produit lui-même n'est pas en mesure d'être déconnecté.
 - › un dispositif de déconnexion, s'il est prévu dans le produit ou s'il en fait partie, doit déconnecter les deux pôles simultanément
 - › l'interconnexion des circuits électriques de différents produits ne présente aucun risque électrique
- › Un dimensionnement suffisant des fils du câble d'alimentation doit être choisi - en fonction des spécifications électriques maximales figurant sur l'étiquette du produit - comme stipulé par les réglementations EN62368-1 ou VDE0100 ou EN60204 ou UL61010-1.

2.3. Electrostatic Discharge (ESD)

A sudden discharge of electrostatic electricity can destroy static-sensitive devices or micro-circuitry. Therefore, proper packaging and grounding techniques are necessary precautions to prevent damage.

Always take the following precautions:



ESD Sensitive Device!

Keep electrostatic sensitive parts in their containers until they arrive at the ESD-safe workplace. Always be properly grounded when touching a sensitive board, component, or assembly.

For more Information, see the Special Handling and Unpacking Instruction within this user guide and Chapter 2.4: Grounding Methods.

2.4. Grounding Methods

The following measures help to avoid electrostatic damages to the device:

- › Cover workstations with approved antistatic material. Always wear a wrist strap connected to the workplace, as well as properly grounded tools and equipment.
- › Use antistatic mats, heel straps, or air ionizers for more protection.
- › Always handle electrostatically sensitive components by their edge or by their casing.
- › Avoid contact with pins, leads, or circuitry.
- › Switch off power and input signals before inserting and removing connectors or connecting test equipment.
- › Keep the work area free of non-conductive materials such as ordinary plastic assembly aids and styrofoam.
- › Use field service tools such as cutters, screwdrivers, and vacuum cleaners that are conductive.
 - › Always place drives and boards with the PCB-assembly-side down on the foam.

2.5. Instructions for Lithium Battery

The product is equipped with a lithium battery, there is a risk of explosion if the lithium battery is replaced incorrectly (short-circuited, reverse-poled, wrong lithium battery type). Dispose of used batteries according to the manufacturer's instructions. For more information, see Chapter 14.2: Replacing Lithium Battery.

⚠ CAUTION

Danger of Explosion if the lithium battery is incorrectly placed!

- › Replace only with the same or equivalent type recommended by the manufacturer
- › Dispose of used batteries according to the manufacture's instructions

ATTENTION- Risque d'explosion avec l'échange inadéquat de la batterie!

- › Remplacement seulement par le même ou un type équivalent recommandé par le producteur
- › L'évacuation des batteries usagées conformément à des indications du fabricant

VORSICHT- Explosionsgefahr bei unsachgemäßem Austausch der Batterie!

- › Ersatz nur durch denselben oder einen vom Hersteller empfohlenen gleichwertigen Typ
- › Entsorgung gebrauchter Batterien nach Angaben des Herstellers



The product is not designed to operate without a lithium battery. If the lithium battery is empty or disconnected, the BIOS settings will be set to the factory defaults.



Do not dispose of lithium batteries in general trash collection. Dispose of the lithium battery according to the local regulations dealing with the disposal of these special materials, (e.g. to the collecting points for dispose of batteries).

3/ Shipment and Unpacking

3.1. Packaging

The KBox B-203-RPL is packaged together with all parts, in a product specific cardboard package designed to provide adequate protection and absorb shock.

3.2. Unpacking

To unpack the product perform the following:

1. Remove packaging.
2. Do not discard the original packaging. Keep the original packaging for future transportation or storage.
3. Check the delivery for completeness by comparing the delivery with the original order.
4. Keep the associated paperwork. It contains important information for handling the product.
5. Check the product for visible shipping damage.

If you notice shipping damage or inconsistencies between the contents and the original order, contact your dealer.

3.3. Scope of Delivery

This scope of delivery describes the parts included in your delivery. Check that the delivery is complete, and contains the items listed. If damaged or missing items are discovered, contact your dealer.

Table 1: Scope of Delivery

Part Number	Quantity	Part Description
KBox B-203-RPL	1	KBox B-203-RPL factory configured with all ordered options: <ul style="list-style-type: none"> › System memory › Storage M.2 SSD (RAID support) › Wi-Fi/BT® › Power options: DC IN 12 VDC (150 W) or DC IN 24 VDC Delivered with four adhesive rubber feet and the power cable for your region or mating power connector for 24 VDC

3.4. Accessories and Spare Parts

Table 2: List of Accessories and Spare Parts

Part	Order Information	Description
	Manufacturer: Kontron Article Number: 0-0062-3268	Phoenix 3-pin power connector (PSC 1.5/3-F)
	Manufacturer: Kontron Article Number: TBD	External AC/DC (150 W) power supply (100/240 VAC to 12 VDC)
	Manufacturer: Kontron Article Number: 0-0064-2173	Power Cable EU Euro (Type-A), 2.5 m
	Manufacturer: Kontron Article Number: 0-0064-4173	Power Cable UK UK (Type-C), 2.5 m
	Manufacturer: Kontron Article Number: 0-0064-4317	Power Cable US US, 2 m
	Manufacturer: Kontron Article Number: TBD	The wall mount bracket kit includes: <ul style="list-style-type: none"> ➤ One bracket ➤ Four M3x6 screws
	Manufacturer: Kontron Article Number: 0-0067-006	Chassis feet <ul style="list-style-type: none"> ➤ Four round adhesive rubber feet
	Manufacturer: SparkLan Article Number: R3410A10050	Product Name: AD-501AX Connector: RPSMA plug (male) Type: Dipole Antenna Frequency: 2.4 GHz/5 GHz/6 GHz Peak gain: 3.7dbi/5dBi/5dBi Hinge: 0° to 90° Impedance: 50 ohms Dimensions: (LxWxT): 162 x 22 x 13.6 mm



For reference expansion device information, see to Table 7: Reference Expansion Devices.

3.5. Type Label and Product Identification

The type label contains specific product identification information and KBox B-203 RPL technical information.

Figure 2: Type Label Example

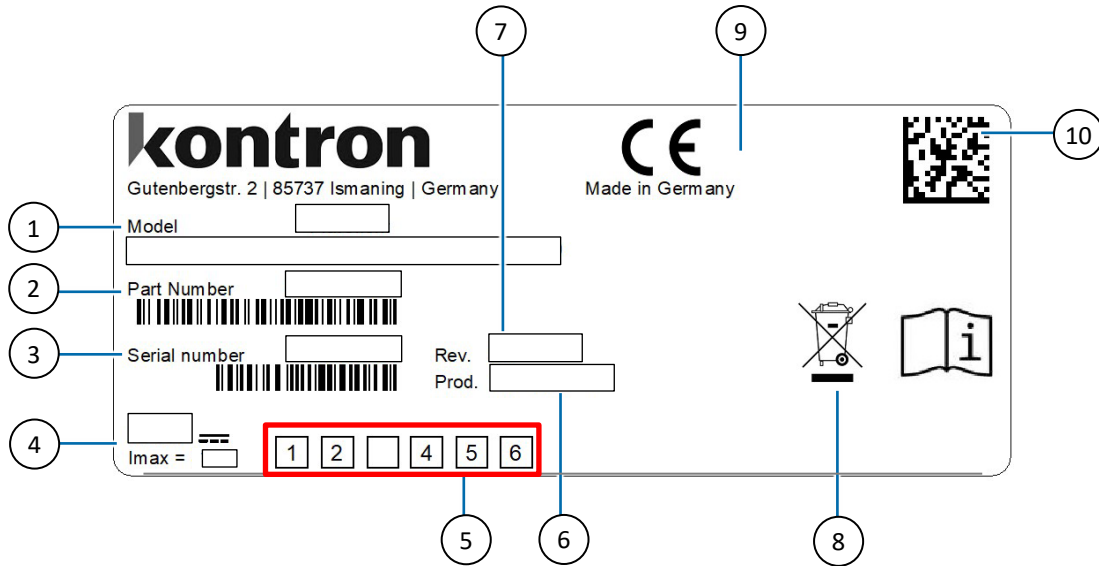

- | | |
|-------------------------------|-------------------------|
| 1. Product family | 6. Production date |
| 2. Part Number | 7. Revision |
| 3. Serial Number and bar code | 8. Disposal Information |
| 4. Electrical specification | 9. Compliance |
| 5. For Internal use [1 to 6] | 10. QR-Code |

CAUTION

For the electrical specification of your product, refer to the product's Type Label.

4/Product Features

Before using the KBox B-203-RPL, Kontron recommends new users to take a few minutes to learn about the product's various features.

4.1. Front Panel

The front panel features the power button, two USB 3.2 Gen 1 ports, and ventilation openings for air-output.

Figure 3: Front Panel

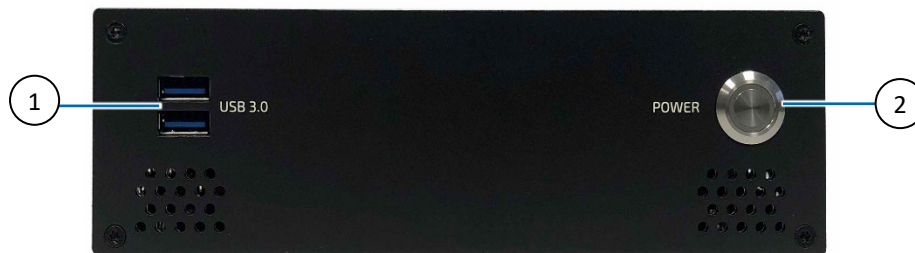

1. 2x USB 3.2 Gen 1 ports

2. 1x Power button with LED

4.1.1. Power Button (POWER)

The power button switches on or switches off the product and includes an integrated power LED that illuminates blue in the 'on' state. Pressing the power button for longer than four seconds initiates a forced system shutdown, and switches the product from the 'on' to the 'off' state.

NOTICE

Performing a forced shut down can lead to loss of data or other undesirable effects!
To shutdown without data loss, use the power button.

4.1.2. USB 3.2 Gen 1 Ports (USB 3.0)

The two front panel USB ports are USB 3.2 Gen 1 Type-A ports. Kontron recommends the use of USB 3.2 Gen 1 compliant devices or cables only. The use of devices and cables that violate the USB 3.2 Gen 1 specification may cause conditions such as non-recognition of the device or read/write errors. Further USB ports are available on the rear panel.



The two USB 3.2 Gen 1 ports are backwards compatible with earlier USB 3.0 versions and USB 2.0.

For the USB 3.2 Gen 2 pin assignment, see Chapter 13.3: USB 3.2 Gen 2/1 Port Pin Assignment.

4.2. Rear Panel

The rear panel features the main I/O interfaces, one DC IN power connector (12 VDC or 24 VDC), two RP-SMA antenna connectors (option), potential equalization stud, Kensington lock, and two top cover fastening screws.

Figure 4: Rear Panel

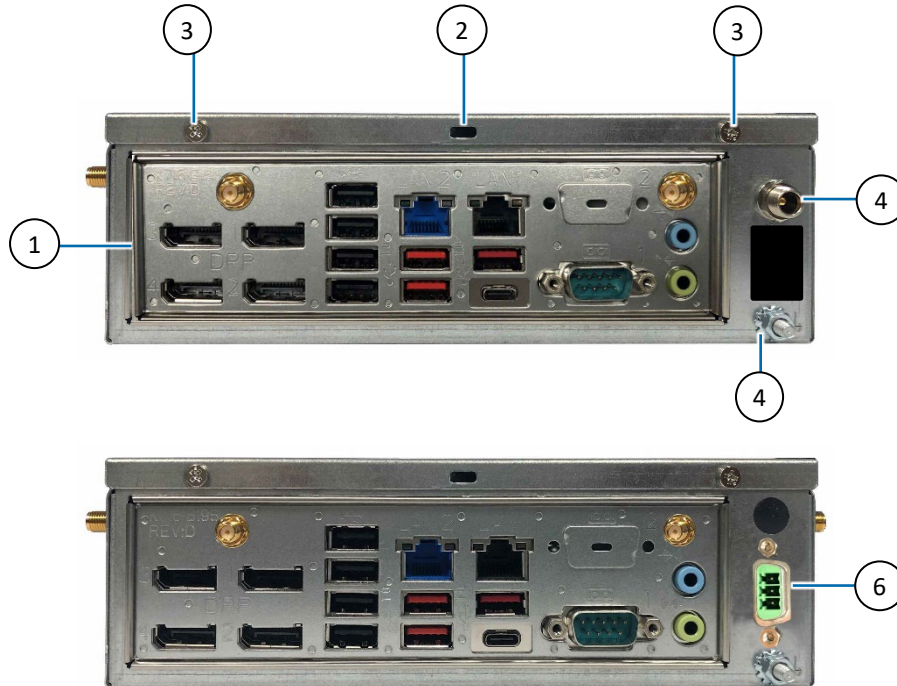

- | | |
|------------------------------|--|
| 1. 1x Interface Panel | 4. 12 VDC DC IN Power Jack (default) |
| 2. 1x Kensington lock | 5. 1x Potential equalization stud |
| 3. 2x Cover fastening screws | 6. 24 VDC DC IN 3-pin connector (option) |

4.2.1. Power Connector

4.2.1.1. 12 VDC DC IN (150 W) (default)

The 12 VDC DC IN power jack connects to the AC/DC 150 W PSU (100/240 VAC to 12 VDC) delivered with the product and chosen to meeting the power specification stated on the product's type label and in Chapter 12.4: Power Specification.

CAUTION

Power the product with the supplied external AC/DC (150 W) PSU only.

For the pin assignment, see Chapter 13.1: 12 VDC DC IN Power Jack Pin Assignment.

4.2.1.2. 24 VDC DC IN (option)

The 24 VDC DC IN 3-pin power connector connects to an external 24 VDC power supply that meets the power specification stated on the product's type label and in Chapter 12.4: Power Specification.

The 3-pin mating power connector delivered with the product must be wired suitably by the user as described in Chapter 9.2.2.1: Wiring the 3-pin Mating Power Connector.

CAUTION

When connecting the 3-pin mating power connector (PSC 1.5/3-F) to the 24 VDC DC IN connector, securing with the two bolts provided and pay attention to the polarity of the connections.

CAUTION

Only connect to an external 24 VDC power supply that meets the product's electrical specification displayed on the product type label, and the power consumption, power limitation and power protection requirements specified in this user guide. The 24 VDC power supply must automatically recover from AC power loss and startup under peak loading.

For the pin assignment, see Chapter 13.2: 24 VDC DC IN 3-Pin Connector Pin Assignment (option).

4.2.2. Potential Equalization Stud

The potential equalization stud ensures that all connected systems share a common potential. When connecting cables, always connect the potential equalization stud first.



The potential equalization stud ensures that all connected systems share a common potential.

4.2.3. Kensington Lock

The Kensington lock slot supports the installation of a standard Kensington lock system that provides an added level of security to prevent theft and third party access to internal sensitive data stored on the product.

**Kensington Lock**

Use the Kensington lock to prevent theft and 3rd party access to sensitive data stored on the product.

4.2.4. Interface Panel

Figure 5: Interface Panel

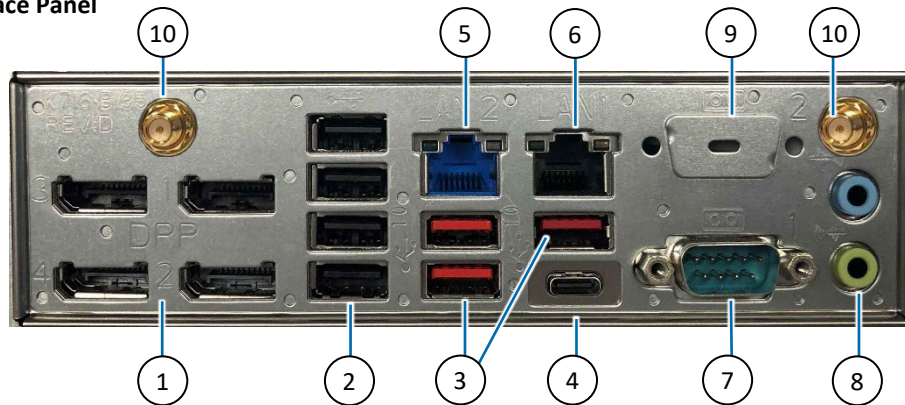

- | | |
|---------------------------|-------------------------------------|
| 1. 4x DPP (DPP1-DPP4) | 6. 1x 1 GbE (LAN1) |
| 2. 4x USB 2.0 (↔) | 7. 1x COM RS232 (1) |
| 3. 3x USB 3.2 Gen 2 (↔) | 8. 1x Audio (Line-In & Line-Out) |
| 4. 1x USB-C 3.2 Gen 2 (↔) | 9. 1x Breakout panel (option) |
| 5. 1x 2.5 GbE (LAN2) | 10. 2x Wi-Fi/BT® antenna connectors |

4.2.4.1. USB 3.2 Gen 2 Ports

The three USB ports (Figure 5, pos. 3) are USB 3.2 Gen 2 Type-A ports. Kontron recommends the use on USB 3.2 Gen 2 compliant devices or cables only. The use of devices and cables that violate the USB 3.2 Gen 2 specification may cause conditions such as non-recognition of the device or read/write errors.



All USB 3 connectors provide separate signal lines for USB 3.2 and USB 2.0 and are backwards compatible with earlier USB 3.0 versions and USB 2.0.



For USB 3.2 Gen 2 cabling, use only Hi-Speed USB cable as specified in the USB 3.2 Gen 2 standards.

For the pin assignment, see Chapter 13.3: USB 3.2 Gen 2/1 Port Pin Assignment.

4.2.4.2. USB-C 3.2 Gen 2 Port

The USB Type-C port (Figure 5, pos. 4) USB 3.2 Gen 2 ports. Power delivery not supported.

For the pin assignment, see Chapter 13.4: USB-C 3.2 Gen 2 Port Pin Assignment.

4.2.4.3. USB 2.0 Ports

The four USB ports (Figure 5, pos. 2) are USB 2.0 ports. The USB 2.0 ports connect to USB 2.0 devices only.

For the pin assignment, see Chapter 13.5: USB 2.0 Pin Assignment.

4.2.4.4. Display Port (DP)

The four DP V1.4a ports (Figure 5, pos. 1) are Display Port ++ compatible with a maximum resolution of 3840 x 2160 @ 60 Hz and enable the connection of up to four simultaneous digital displays directly or with an adapter. Using an adapter to convert a DP signal to DVI or HDMI may cause disturbance.



It is possible to use an adapter:

- › DP to HDMI (passive / active)
- › DP to DVI (passive / active)
- › DP to VGA (active)

Depending on the required resolution, the following maximum number of simultaneous displays can be supported.

Table 3: Display Resolution

Display Resolution	Number of Simultaneous Displays	Display Resolution
8k @ 60Hz HDR or	1 port / 1 pipe, = High Dynamic Range Video	8k @ 60Hz HDR or
5k @ 120Hz HDR	2 (simultaneous), = High Dynamic Range Video	5k @ 120Hz HDR
8k @ 60Hz SDR	4 (simultaneous), = Standard Dynamic Range Video	8k @ 60Hz SDR

Table 4: Display Order Priority Chain

Order of Priority	Priority 1	Priority 2	Priority 3	Priority 4	Priority 5
Display Type	eDP/LVDS	DP1	DP2	DP3	DP4

For the pin assignment, see Chapter 13.6: Display Port (DP) V1.4a Pin Assignment.

4.2.4.5. LAN Ports

The LAN ports supports one 2.5 GbE port (Figure 5, pos. 5) implemented using the Intel® i226LM Ethernet controller and one GbE port (Figure 5, pos. 6) implemented using the Intel® i219LM Ethernet controller. The RJ45 LAN connectors include speed and link activity status LEDs, and support Teaming and Time Sensitive Networking (TSN).



Use Shielded LAN cable to meet CE Class B and FCC/B requirements.



The Intel® Ethernet i226 LAN Controller series experiences sporadic networking connection drops with certain routers/switches when Energy Efficient Ethernet (EEE) is enabled.

For users experiencing this problem, disable the “EEE” mode in the Advanced Windows/ Linux driver setting.

For the pin assignment, see Chapter 13.7: LAN 2.5 GbE/1 GbE Connector Pin Assignment.

4.2.4.6. COM Port (option)

The COM port (Figure 5, pos. 7) enables the connection of a RS232 compatible serial device.

For the pin assignment, see Chapter 13.8: COM Port Pin Assignment.

4.2.4.7. Audio (Line-In, Line-Out)

The audio jacks line input (Line-In /MIC) and headphone output (Line-Out) (Figure 5, pos. 8) enable the connection of full High Definition (HD) devices. For Audio configuration, the Microsoft Windows Control Panel 'Sound' option can be used to choose the input and output HD audio device, and set the volume level.



Line-Input Supports:

- › Line: stereo max. 1.3 Vrms (Gain=0 dB) input voltage
 - › Microphone: electric microphones with 1.3 Vrms (Gain=0 dB) or 0.13 Vrms (Gain=20 dB)
- Headphone Output Supports
- › Stereo max. 1.2 Vrms output voltage at 32 Ohm load



Install the audio cable before setting up the audio device in MS Windows.

If MS windows is installed before the audio cable is connected remove the HD audio device within Windows device Manager. After automatic re-installation, audio works as expected.

For the pin assignment, see Chapter 13.9: Audio (Line-In & Line-Out) Connector Pin Assignment.

4.2.4.8. Wi-Fi/BT® Antenna Connectors (option)

The two Wi-Fi/BT® antenna connectors (Figure 5, pos. 10) are type RP-SMA female and support Wi-Fi 6E/BT 5.3. The product is delivered with Kontron reference antenna (type: RP-SMA male). Alternatively, two Wi-Fi/BT® antenna are available on the product's right side.

⚠ CAUTION

Avoid RF antenna exposure by:

- › Avoid placing the antenna near people, minimum distance 20 cm
- › Avoid pointing the antenna at people
- › Keep a safe distance from the antenna especially when transmitting

NOTICE

RP-SMA and SMA Antenna are not Interchangeable!

RP-SMA and SMA antenna are not electrically compatible and not interchangeable. Ensure you have use the correct antenna type. If the RP-SMA connector is mixed with an SMA antenna, the connector's center pin may be damaged.



Kontron recommends the use of Kontron's Wi-Fi/BT® antenna chosen to meet RF requirements and with a nominal impedance of 50 ohms, see Table 2: List of Accessories.

For the pin assignment, see Chapter 13.11: Antenna Wi-Fi/BT® Pin Assignment.

4.2.4.9. Breakout Panel

The breakout panel supports an additional COM RS2323 port for RS232 compatible serial device or an S/PDIF output for a digital audio optical output supporting 5.1 Multichannel and the direct connection of digital audio devices.



S/PDIF: To achieve high quality data transfer, Kontron recommends the use of optical cables.

For the pin assignment, see Chapter 13.8: COM Port Pin Assignment or Chapter 13.10: S/PDIF Pin Assignment (option).

4.3. Left and Right Side

The right side features two possible Wi-Fi/BT® antenna connector type RP-SMA female to support Wi-Fi 6E/BT 5.3. Alternatively, two Wi-Fi/BT® antenna connectors are available on the rear panel.

⚠ CAUTION

Avoid RF antenna exposure by:

- › Avoid placing the antenna near people, minimum distance 20 cm
- › Avoid pointing the antenna at people
- › Keep a safe distance from the antenna especially when transmitting

NOTICE

RP-SMA and SMA Antenna are not Interchangeable!

RP-SMA and SMA antenna are not electrically compatible and not interchangeable. Ensure you have use the correct antenna type. If the RP-SMA connector is mixed with an SMA antenna, the connector's center pin may be damaged.



Kontron recommends the use of Kontron's Wi-Fi/BT® reference antenna chosen to meet RF performance requirements and with a nominal impedance of 50 ohms, see Table 2: List of Accessories.

For the pin assignment, see Chapter 13.11: Antenna Wi-Fi/BT® Pin Assignment.

Figure 6: Left and Right Sides



1. 2x Wi-Fi/BT® antenna (right side)
2. Ventilation openings (left and right sides)

4.4. Top Cover and Bottom Sides

The top cover features ventilation openings. An internal processor fan draws in air through the top cover's ventilation openings and distributes the incoming air over critical internal components.

Figure 7: Top Cover

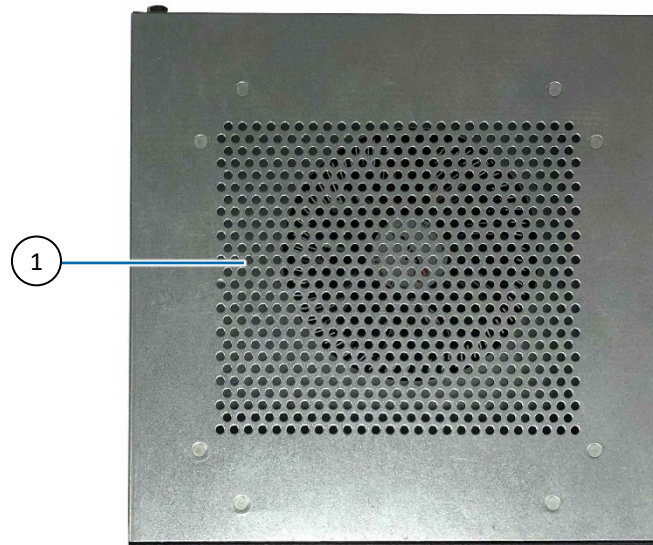

1. Ventilation openings (air-intake)

The bottom side features four threaded screw holes used to fasten the wall mount bracket to the product. For desktop use attach the four chassis feet, delivered with the product, to each corner on the bottom side to ensure stability. Care must be taken not to position the chassis feet over the four threaded screw holes required when installing the wall mount bracket.



Before installing the wall mount bracket remove the four chassis feet if previously installed.

Figure 8: Bottom Side

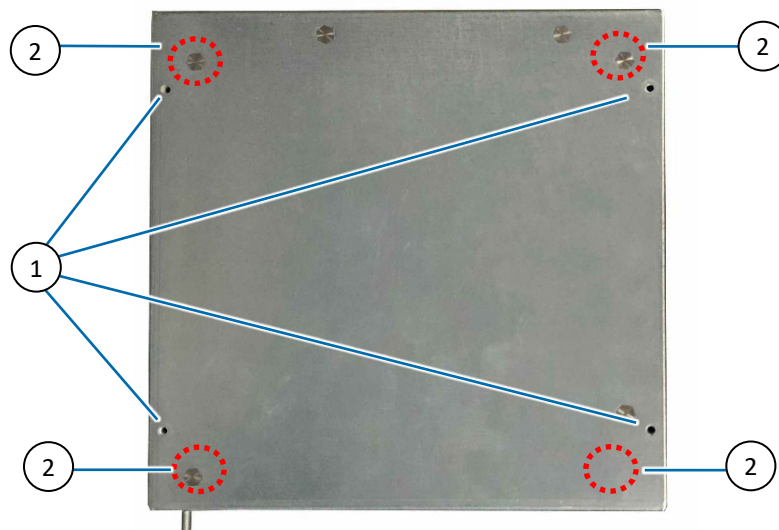

1. 4x Threaded screw holes
2. 4x Chassis feet (position)

5/System Expansion

5.1. Before Expanding

The KBox B-203-RPL supports expandability in a compact design and is factory configured according to the users ordered hardware configuration. Before expanding the product, consider which sockets are free for installation. Free sockets are available for expansion. Kontron recommends the use of Kontron's reference devices to expand the product. Users are responsible for considering the product's maximum allowed power consumption and must take cooling into consideration. Pay attention to the manufacturer's OS specifications for integrated hardware components.

The product supports two internal stacked M.2 sockets for Wi-Fi/BT® and storage (SSD).



The lower socket's module can only be accessed by removing the upper socket's module.

5.2. Internal M.2 Sockets

Figure 9: M.2 Sockets (stacked)

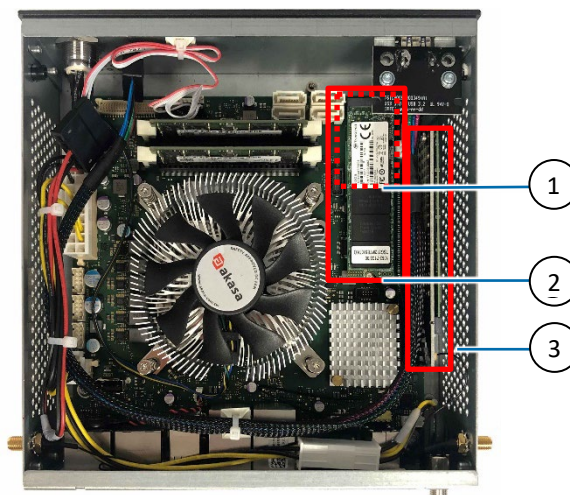

1. M.2 Wi-Fi/BT® (lower socket)
2. M.2 SSD (upper socket)
3. PCIe to M.2 adapter with M.2 2280 NVMe SSD

5.2.1. Wi-Fi/BT® (option)

The M.2 Wi-Fi/BT® module option populates the lower M.2 2230 Key E socket. When populated with an M.2 module, the socket is not available for other M.2 modules.

Table 5: Wi-Fi/BT® Option

Motherboard Socket	Interface	Quantity	Expansion Device
M.2 2230 Key E (lower Socket)	PCIe x1/ USB 2.0	1	M.2 2230 Wi-Fi 6E, 6 GHz (Gig+) / Bluetooth® 5.3 Interfaces: Wi-Fi – PCIe and Bluetooth - USB 2.0

5.2.2. Storage (option)

The M.2 SSD module option populates the upper M.2 2280 Key M socket and the motherboard's PCIe16 slot may be populated with a PCIe to M.2 Card, to enable the implementation of a second M.2 SSD module. When populated with an M.2 module, the socket is not available for other M.2 modules.

Table 6: Storage Option

Motherboard Socket/Slot	Interface	Quantity	Expansion Device
M.2 2242/2280 Key M (upper Socket)	PCIe x4	1	M.2 2280 NVMe SSD (up to 4 TByte)
PCIe x16 Gen 5 slot	PCIe x4	1	PCIe to M.2 adapter with M.2 2280 NVMe SSD (up to 4 TByte)



For RAID, two M.2 2280 NVMe SSDs with the same density must be installed.



No support for SATA based M.2 modules.

5.3. Reference Expansion Devices

When installing a reference M.2 module adhere to the manufactures requirements and the prerequisite requirements stated in Table 7: Reference Expansion Devices

NOTICE

When installing expansion devices users must adhere to the manufactures requirements and any prerequisite requirements stated within this user guide.



Kontron is not responsible for problems occurring after the installation expansion devices that have not been factory installed and configured by Kontron.

Table 7: Reference Expansion Devices

Expansion Device	Description
M.2 Key E WI-FI/BT [®] Module	Manufacturer: Intel [®] Article Number: AX210.NGWG.II Intel [®] Wi-Fi 6E AX210 (Gig+) Extended Temperature Industrial Module WI-FI 6E/BT 5.3 Form factor: M.2 key E Interface: PCIe (Wi-Fi) and USB 2.0 (BT)
Wi-Fi/BT [®] Antenna	Manufacturer: SparkLan Article Number: R3410A10050 Product Name: AD-501AX Connector: RPSMA plug (male) Type: Dipole Antenna Frequency: 2.4 GHz/5 GHz/6 GHz Peak gain: 3.7dbi/5dBi/5dBi Dimensions: (LxWxT): 162 x 22 x 13.6 mm and Hinge: 0° to 90° Impedance: 50 ohms

Expansion Device	Description
PCIe to M.2 Adapter board	Manufacturer: DELOCK Article Number: 90300 DELock PCI Express x16 card for 1 x NVMe M.2 Key M.
M.2 Key M SSD Module	Manufacturer: Transcend Article Number: TS256GMTE760T (246 GByte) TS512GMTE720T (512 GByte) TS1TMTE720T (1 TByte) TS2TMTE720T (2 TByte) TS4TMTE720T (4 TByte) Transcend MTE720T PCIe x4 2280 Form factor: M.2 Key M SSD Module Interface: NVMe PCIe Gen 4x4

6/Thermal Management

6.1. Active Cooling

The KBox B-203-RPL is actively fan cooled. An internal processor fan draws in air through the top cover's ventilation openings and distributes the incoming air over critical internal components before exiting through ventilation openings on the right side, left side and front panel.

Obstructing ventilation openings may cause overheating

⚠ CAUTION

Do not to place items directly in front of the top cover ventilation openings and observed that all ventilation openings are not covered or obstructed.

Figure 10: Ventilation Openings

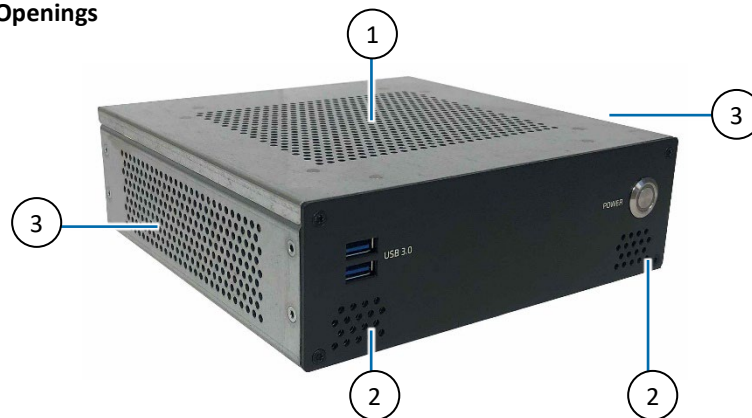

- | | | | |
|---|------------------------------------|---|---|
| 1 | Top cover ventilation (air-intake) | 3 | Left and right side ventilation(air exit) |
| 2 | Front panel ventilation (air exit) | | |

6.2. Mount Orientation

Mount the product horizontally with the cover facing upward or vertical in all directions. Mounting the product with the top cover facing downwards is not permitted. If the top cover faces downwards, not enough air enters the product to cool the processor adequately. This may cause overheating or melting, and is a possible fire hazard due to hot substances exiting through the cover's ventilation opening.

Danger of Fire

Mounting the product with the top cover facing downward is not permitted and may cause overheating or melting, and hence may cause a fire hazard or personal injury.

To avoid risk of fire and personal injury, observe the following:

⚠ WARNING

- › Do not mount with the top cover facing downward
 - › Only use the permitted mount orientations:
 - › Horizontally (only top cover facing upwards)
 - › Vertically (all mount orientations)
-

6.3. Minimum Clearance (Keep out Area)

To provide maximum airflow through and around the product a minimum distance to the surrounding environment must be observed know as keep out area in this user guide. Before installing the product, ensure that the keep out areas have been observed.

Consider additional clearance requirements due to installed Wi-Fi/BT® antennas on the rear panel or right side, where the antenna hinge clearance is approximately depth 45 mm and height 130 mm.

Leave sufficient clearance (keep out area) to prevent the product from overheating!
To ensure proper operation use the specified recommended keep out areas of :

⚠ CAUTION

- › Top cover: 10 mm (0.394")
 - › Left and right sides: 10 mm (0.394")
 - › Front and rear panel: 10 mm (0.394")
 - › Bottom side: (no restriction)
-

6.4. Third Party Components

When configuring the product with third party components such as M.2 modules, an approximate internal temperature rise is given and must be taken into consideration.

7/Assembly

7.1. Before Assembling

Before opening the KBox B-203-RPL to access internal components, observe the safety instructions within this chapter and the safety instructions in Chapter 2/General Safety Instructions. Before installing or removing third party products, consult the documentation provided by the components manufacturer.

Kontron recommends expanding the product, before installation.

⚠ WARNING

Before opening the product, make sure that the product is disconnected, by disconnecting the power cable from the DC IN power connector or the power source.

⚠ CAUTION

Handling and operation of the product is permitted only for skilled personnel aware of the associated dangers, within a work place that is access controlled and fulfills all necessary technical and environmental requirements.



Follow the safety instructions for components that are sensitive to Electrostatic Discharge (ESD) and use a clean, flat and ESD-safe surface when handling the product. Failure to observe this warning notice may result in damage to the product or/and internal components.

7.2. Opening the Product

⚠ WARNING

Before opening the product, make sure that the product is disconnected, by disconnecting the power cable from the DC IN power connector or the power source.

NOTICE

Do not slide the Top Cover!

To avoid contact and/or possible damage between the top cover and the internal fan, do not slide the top cover along the chassis. Always move the top cover vertically upwards or downwards on to or away from the chassis.



Kensington Lock

Use the Kensington lock to prevent theft and third party access to sensitive data stored on the product.

To open the KBox B-203-RPL to gain access to internal components, perform the following:

1. Close all applications. Shut down the product properly using the power button and disconnect the power cable from the power source or the DC IN power connector. Disconnect all peripherals.
2. Place the product on a flat, clean and ESD-safe surface.

3. Unlock and remove the Kensington lock (if installed).

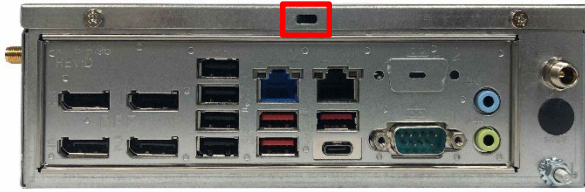

4. Remove the two top cover screws on the rear panel. Retain the screws for later use.



5. Lift the top cover a few centimeters at the rear of the chassis and pull the top cover gently away from the front panel.
6. Lift the top cover vertically to avoid damaging the internal fan assembly. Do not slide the top cover off the chassis!
7. Close the top cover, by proceeding in the reverse order (steps 6 to 3).

7.2.1. Installing and Removing an M.2 Wi-Fi/BT® Module

When installing modules in both sockets, install the M.2 Wi-Fi/BT® module in the lower socket first.

NOTICE

Do not use force when fastening the M.2 module to the motherboard. Too much force may damage the motherboard nut. Recommended torque for the M.2 screw is 0.2 Nm.



The M.2 socket is a stacked socket. The lower module must be installed first and can only be accessed by removing the upper module.



If the M.2 SSD has to be removed, after reinstalling the M.2 SSD the partitioning of the memory maybe different.

Figure 11: M.2 Wi-Fi/BT® Socket

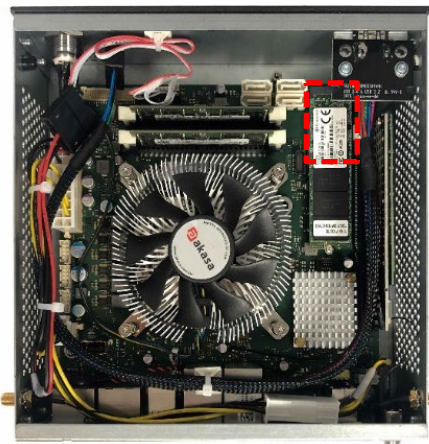

To install or remove the M.2 2230 Wi-Fi/BT® module in the lower socket of the M.2 stacked socket, perform the following:

1. Open the product, as described in Chapter 7.2: Opening the Product, steps 1 to 6.
2. Locate the M.2 stacked socket and the corresponding M.2 2230 key E nut on the motherboard. Note that if an M.2 2280 Key M SSD module populates the upper socket, this module must be removed first.
3. Attach the antenna connector's internal cable to the M.2 module's antenna connectors [1] and [2].
4. Insert the M.2 Wi-Fi/BT® module into the corresponding lower M.2 2230 Key E socket gently and at an angle, until the hole on the M.2 module aligns with the corresponding motherboard's nut. Secure the M.2 Wi-Fi/BT® module by pressing down on the free end, and carefully securing with a screw until flat with the motherboard.
5. If the product's antenna connectors are not installed:
 - › Open the required antenna connector breakouts (on the rear panel or the left side)
 - › Insert the antenna connector with cable through the breakout opening from inside the chassis to the outside.
 - › Secure the antenna connector on the outside with the provided washer and nut.
6. To remove a M.2 Wi-Fi/BT® module, from the M.2 2230 Key E socket, perform the steps 2 to 4 in the reverse order.
7. Close the top cover, as described in Chapter 7.2: Opening the Product, step 7.
8. Screw the delivered Wi-Fi/BT® antenna on to the Wi-Fi/BT® antenna connector.
9. Position the Wi-Fi/BT® antenna, using the antenna's hinge, in the direction required or allowed for by the installation environment.

Avoid RF antenna exposure by:

⚠ CAUTION

- › Avoid placing the antenna near people, minimum distance 20 cm
- › Avoid pointing the antenna at people
- › Keep a safe distance from the antenna especially when transmitting



When installing Wi-Fi/BT® antennas, consider the increase of the minimum clearance to 45 mm and 130 mm.



Kontron recommends the use of Kontron's Wi-Fi/BT® reference antenna chosen to meet RF performance requirements and with a nominal impedance of 50 ohms, see Table 2: List of Accessories.

7.2.2. Installing and Removing an M.2 SSD Module

The M.2 socket is a stacked socket where by the upper M.2 socket is a M.2 2280 Key M socket for a M.2 SSD modules. When installing modules in both sockets install the lower module first and then installing the M.2 SSD module in the upper socket.

The product supports the addition of a PCIe to M.2 adapter installed on the motherboard's PCIe16 Gen 5 slot to provide a second M.2 SSD module. For RAID support M.2 SSDs with the same density must be installed.

NOTICE

Do not use force when fastening the M.2 module to the motherboard. Too much force may damage the motherboard nut. Recommended torque for the M.2 screw is 0.2 Nm.



For RAID, two M.2 SSDs with the same density must be installed.



The M.2 socket is a stacked socket. The lower module must be installed first and can only be accessed by removing the upper module.



After installing or removing a M.2 SSD module the memory partitioning maybe different.

Figure 12: M.2 2280 NVMe SSD Sockets

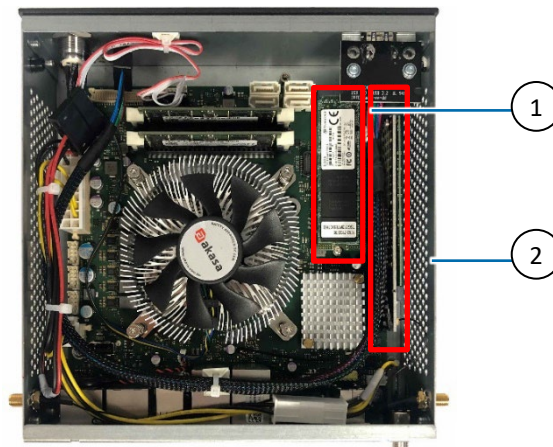

- | | |
|---|--|
| 1. M.2 2280 SSD in upper M.2 stacked socket | 2. M.2 2280 SSD on PCIe to M.2 adapter board |
|---|--|

To install or remove the M.2 2280 SSD module in the motherboard's M.2 stacked M.2 2280 Key M upper socket, perform the following:

1. Open the product, as described in Chapter 7.2: Opening the Product, steps 1 to 6.
2. Locate the M.2 stacked socket and corresponding M.2 2280 key M nut.
3. Insert the M.2 SSD module into the corresponding upper M.2 2280 Key M socket gently and at an angle, until the hole on the M.2 module aligns with the corresponding motherboard's nut. Secure the M.2 SSD module by pressing down on the free end, and carefully securing with a screw until the M.2 SSD module is flat with the motherboard.
4. To remove the M.2 SSD module perform steps 2 to 3 in the reverse order.
5. Close the top cover, as described in Chapter 7.2: Opening the Product, step 7.

To install or remove the PCIe to M.2 Adapter with M.2 2280 SSD module in the motherboard's PCIe x16 slot, perform the following:

1. Open the product, as described in Chapter 7.2: Opening the Product, steps 1 to 6.

2. Insert the M.2 2280 SSD module into the M.2 2280 Key M socket on the PCIe to M.2 adapter gently and at an angle, until the hole on the M.2 SSD module aligns with the corresponding adapter board's nut. Secure the M.2 SSD module by pressing down on the free end, and carefully securing with a screw until the m.2 SSD module is flat with the PCIe to M.2 adapter board.
3. Insert the PCIe to M.2 adapter board with M.2 SSD module into the PCIe x16 slot on the motherboard by pressing down gently until the PCIe to M.2 adapter board snaps into place.
4. To remove the M.2 SSD module perform the steps 2 to 3 in the reverse order.
5. Close the top cover, as described in Chapter 7.2: Opening the Product, step 7.

8/Installation

8.1. Before Installing

Before installing the KBox B-203-RPL in the operating environment, ensure that the operating environment meets the specification stated within this user guide, and that there is sufficient access to the product's power connector (DC IN), and the front and rear panel I/O interface connectors. Kontron recommends expanding the product with expansion cards and storage, before installing the product in the end environment.

Install and operate the product only horizontally with the top side facing upward or vertically in all directions. It is not permitted, to operate the product with the top side facing downwards. Leave sufficient clearance (keep out area) to prevent the product from overheating by using the minimum clearance distances specified in this user guide, see Chapter 6.3: Minimum Clearance (Keep out Area).

Danger of Fire

It is not permitted to mount the product upside down! Mounting the product with the top cover facing downward may cause overheating or melting, and hence is a fire hazard or may cause personal injury.

⚠ WARNING

To avoid risk of fire and personal injury, observe the following:

- › DO NOT mount horizontally with the top cover facing downward
 - › Only use the allowed mount orientations:
 - › Horizontally (only top cover facing upwards)
 - › Vertically (all mount orientations)
-

⚠ CAUTION

Do not handle the product if there is any visible damage.

⚠ CAUTION

Prior to installation, ensure that there are no live wires on the installation site and follow the local/national regulations for grounding. The voltage feeds must not be overloaded. Adjust the cabling and the overcurrent protection to correspond with the electrical specification on the type label.

⚠ CAUTION

Obstructing the ventilation openings may cause overheating:

- › Do not to place items directly in front of the top cover ventilation openings
 - › Observed that all ventilation openings are not covered or obstructed by objects
-

⚠ CAUTION

Leave sufficient clearance (keep out area) to prevent the product from overheating!

To ensure proper operation use the specified recommended keep out areas of :

- › Top cover: 10 mm (0.394")
 - › Left and right sides: 10 mm (0.394")
 - › Front and rear panel: 10 mm (0.394")
 - › Bottom side: (no restriction)
-

NOTICE

Support the power and I/O interface cables to minimize strain on the product's connectors.



Ensure there is enough clearance for users to:

- Connect cables on the rear panel
- Access the power button on the front panel
- Install Wi-Fi/BT® antenna on rear panel or right side (clearance 45 mm and 130 mm from hinge)

8.2. Chassis Feet

To use in desktop environments install the four self-adhesive rubber chassis feet on the product's bottom side.

To install the supplied four self-adhesive rubber chassis feet, perform the following:

1. Ensure that the bottom surface is clean and free from dust and dirt.
2. Remove the paper cover from the back of each of the self-adhesive rubber chassis feet and carefully press the rubber chassis feet onto the bottom side.



To improve stability, position the rubber chassis feet between the mounting hole and the outside edge of the corners.

8.3. Wall Mount

To mount on a flat surface use the wall mount bracket, see Table 2: List of Accessories. When mounting provide the specified minimum clearance around the product to ensure air-intake and extraction is not restricted.

⚠ CAUTION

Weight

Ensure the mount surface can support the product's weight. Always use four screws to mount the bracket on the wall, with a suitable screw length for the thickness of the wall.



Install the mounting brackets on the product before mounting on the mount surface.

Figure 13: Wall Mount Bracket

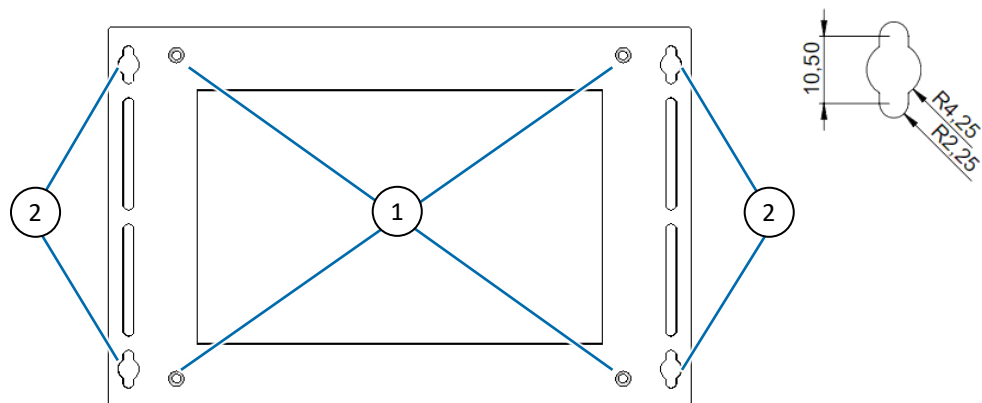

1 4x Mounting holes

2 4x Keyhole openings for wall mount

When mounting, provide the specified minimum clearance around the product to ensure air-intake and extraction is not restricted. Additionally, users may need to consider the mount orientation due to the Wi-Fi/BT® antenna positioning. The wall mount brackets enables mounting with the front panel up (or down) or with the front panel left (or right).

Figure 14: Wall Mount Bracket Orientation

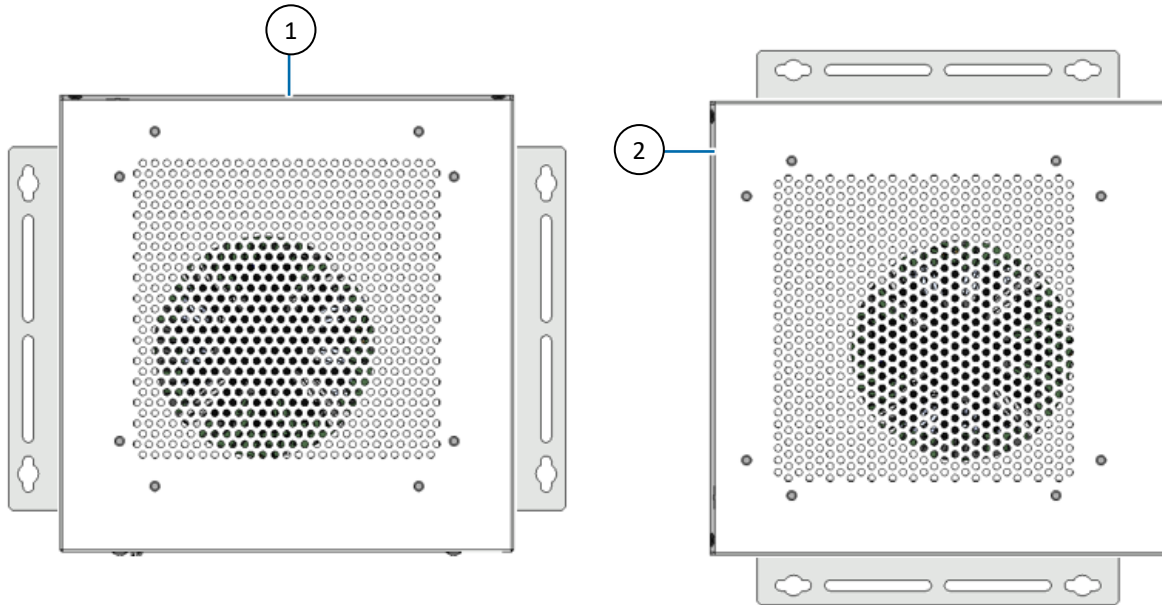

1 Front panel up (or down)

2 Front panel left (or right)

To install the wall mount bracket on the product and mount on a wall, perform the following:

1. Fasten the wall mount bracket to the bottom side of the product using the four M3x6 screws provided with the wall mount bracket and a torx (08x60) screwdriver.
2. Mark the position for the screws using the keyhole mounting openings. Screw four screws suitable for the thickness of the wall, into the wall while leaving a gap of (> 2 mm) between the top of the screw and the wall.
3. Slide the wall mount bracket with the product attached on the screws and pull slightly downwards or to the side, to enable the bracket to sit in the narrow gap.
4. Tighten each of the four screws.

8.4. VESA 100 Mount Assembly Kit

The VESA 100 mount assembly kits mounts the product and the external power supply on the rear side of a VESA 100 monitor. The VESA 100 Mount assembly kits installs directly on the monitor’s rear side or using the monitor’s VESA 100 stand.

Figure 15: VESA 100 Mount Assembly

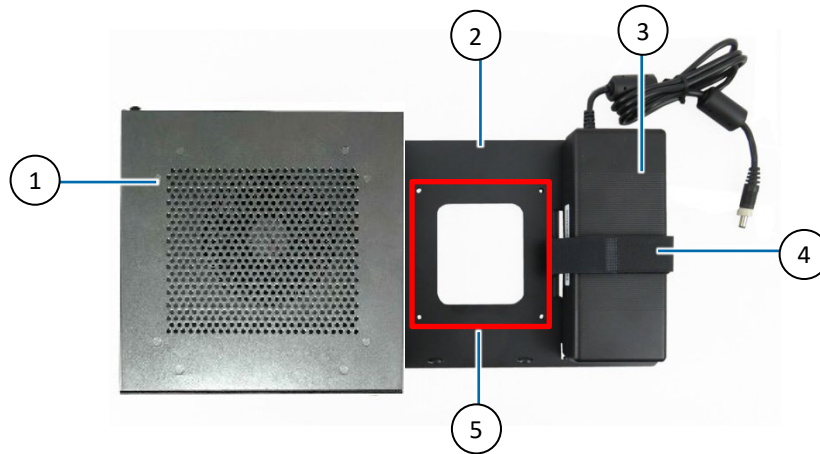

- | | | | |
|---|-------------------------|---|----------------------|
| 1 | KBox B-203-RPL | 4 | Velcro® band |
| 2 | VESA 100 mount frame | 5 | 4x VESA 100 openings |
| 3 | Power Supply Unit (PSU) | | |

The VESA 100 mount assembly kit contains the VESA 100 mounting frame, velcro® band, four M3x 8 mm screw to attach the KBox B-203 to the frame and four M4x20 screws with four 4 mm spacers to attach the frame to the rear side of the monitor.



Using the VESA 100 mount assembly, only vertical mounting is possible.

To assemble the product and power supply on the VESA 100 mounting frame, perform the following:

1. Ensure that the self-adhesive rubber chassis feet are not installed on the bottom side of the product. If the feet are installed, removed the feet before mounting the product on the VESA 100 mounting frame.
2. Align the four mounting holes on the bottom side of the product with the four mounting holes on the VESA 100 mounting frame.

Figure 16: KBox B-203-RPL Mounting Position

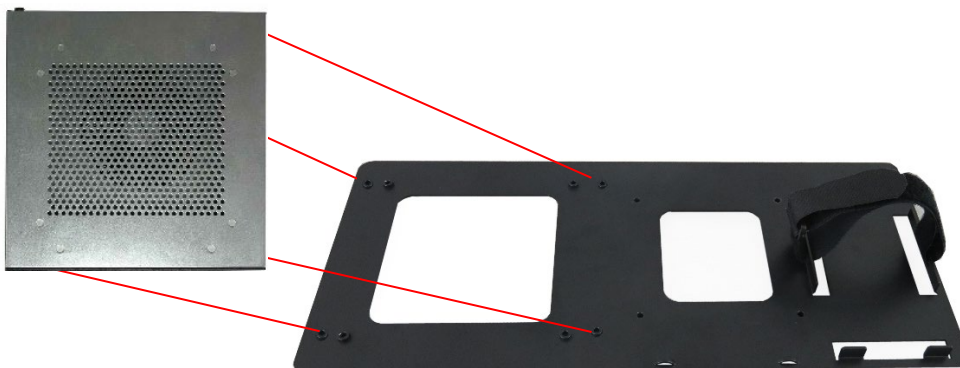

3. Insert the supplied four M3x 8 mm screws into the rear side of the VESA 100 mounting frame and using a Torx screwdriver (10) fasten the product to the VESA 100 mounting frame.
4. Open the flexible Velcro® band to the band's full length and with the rough fastening side facing downward feed the band through the threading slots on the left and right aligning brackets.

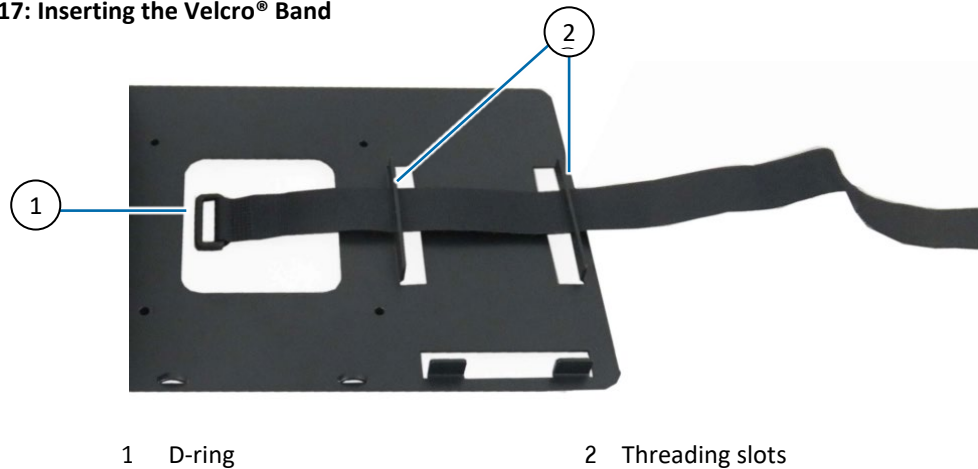
Figure 17: Inserting the Velcro® Band

5. Double back with the flexible Velcro® band and feed the rough end through the band's D-ring. Pull the band through the D-ring and press approximately 30 mm to 50 mm of the self-gripping sides together to form a loose loop. Lift the bottom part of the loop to meet the top part to form a space for the power supply between the band and the VESA 100 mounting frame.

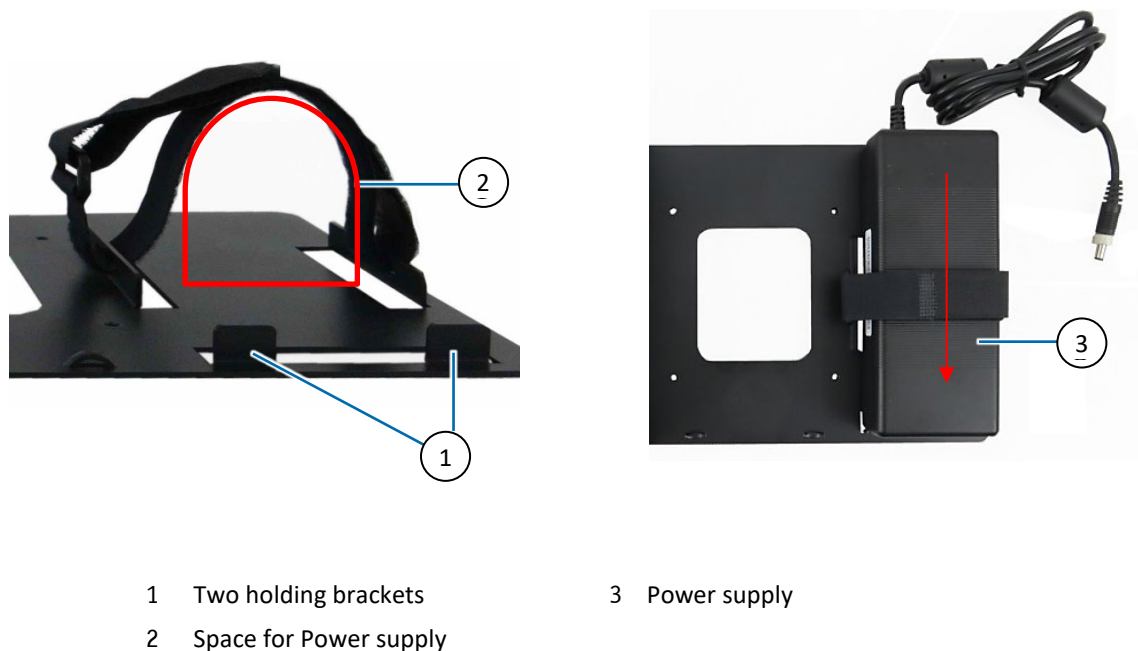
Figure 18: Positioning the Power Supply

6. Slot the power supply, with the 3-pin AC connector facing towards the two holding brackets, into the gap made in step 5 and push down until the power supply rests on the two holding brackets.
7. Secure the power supply by opening the self-gripping sides and pulling the band away from the D-ring as far as possible and securing the band tightly.

8.4.1. Mounting Directly on a Monitor

Figure 19: Direct Mounting on a Monitor

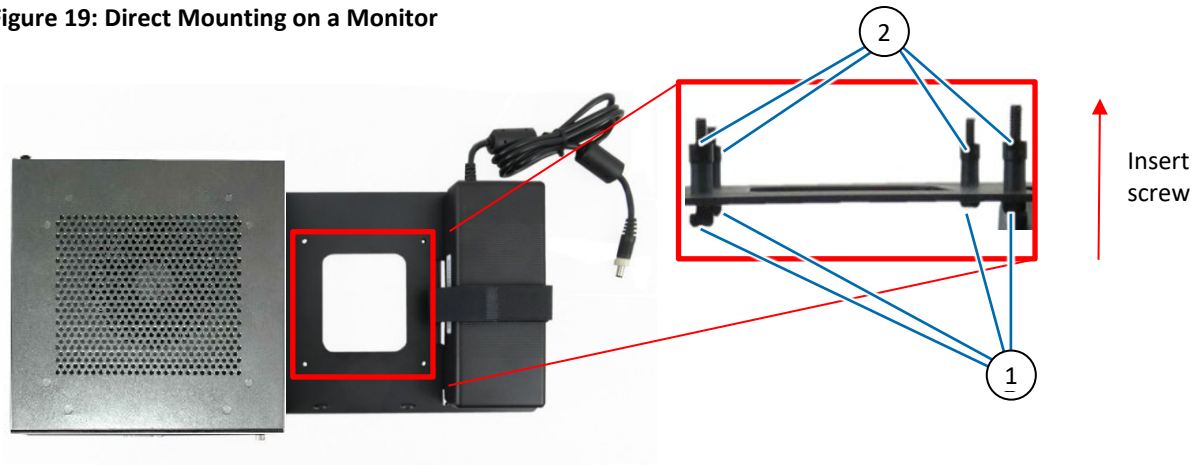

1 4x M4x20 mm screws

2 4x Spacers

To mount the VESA 100 assembly directly onto the rear side of a monitor, perform the following:

1. Feed the four (M4x 20 mm) screws through the four VESA 100 openings on the VESA 100 mount frame and attach one of the supplied spacers on the screw's free end.
2. Insert the free end of the screw (with spacer) into the VESA 100 threaded screw openings on the monitor's rear side.
3. Fasten all four screws to secure the VESA 100 mount assembly.

NOTICE

Always use all four screw and spacers when securing the VESA 100 mount assembly to the rear side of the monitor.



Using the VESA 100 mount assembly, only vertical mounting is possible.

8.4.2. Mounting using the Monitor's VESA 100 Stand

Figure 20: Mounting with a VESA Stand on the Monitor

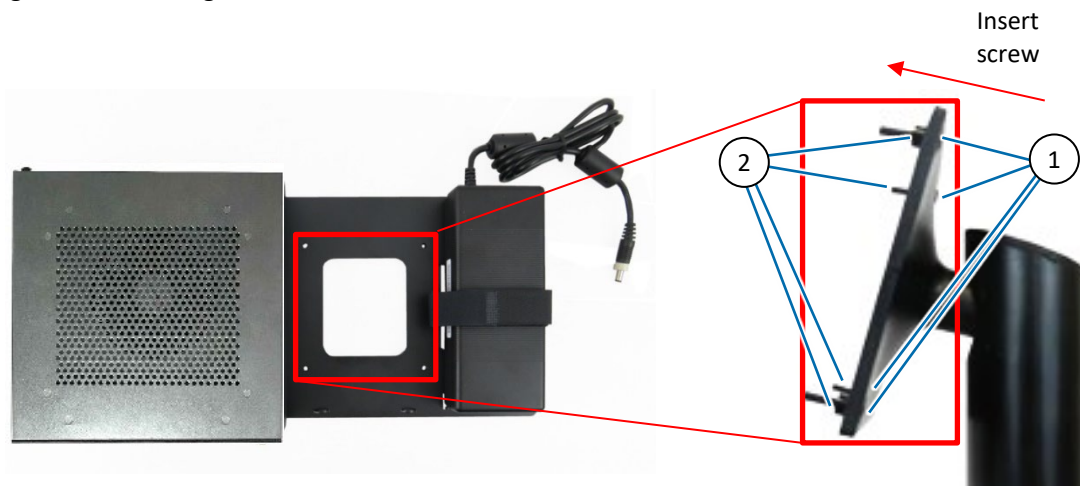

1 4x M4x20 mm screws

2 4x Spacers

To mount the VESA 100 assembly on to the monitor's rear side using the monitor's VESA 100 stand, perform the following:

1. Feed the four (M4x 20 mm) screws through the four VESA 100 openings on the monitor's stand and attach one of the supplied spacers to each screw's free end.
2. Insert the screw's free end (with spacer) through the four VESA 100 openings on the VESA 100 mount frame and then onto the VESA 100 threaded screw opening on the mount hole on the monitor's rear side.
3. Fasten all four screws to secure the VESA 100 mount assembly.

NOTICE

Always use all four screw and spacers when securing the VESA 100 mount assembly with stand to the rear side of the monitor.



Using the VESA 100 mount assembly, only vertical mounting is possible.

9/Starting Up

9.1. Before Starting

Before connecting the KBox B-203-RPL to power, read the instructions in this user guide and observe the safety instructions in Chapter 2/General Safety Instructions

The product comes hardware configured, and on request with a pre-installed Operating System (OS) and all the necessary drivers (in accordance with the ordered hardware configuration). No further internal configuration is required, enabling full operation when connected to power and switched on for the first time.

Operate in the closed condition only

⚠ CAUTION

Ensure the product is closed (top cover secured with the two screws) before connecting the power. It is only ensured that users do not have access to internal components during operation when the product is closed.

Switching Off

⚠ CAUTION

Even when switched off using the power button, parts of the product are still energized. The product is only completely switched off when switched off using the power button and the power cable is disconnected from either the DC IN power connector or the power source.

Only connect the product to the supplied external power solution providing the voltage type (AC or DC) and the input power (max. current) specified on the Kontron Product Label and meeting the requirements of the Limited Power Source (LPS) and Power Source (PS2) of UL/IEC 62368-1.

⚠ CAUTION

Disconnection Device (24 VDC option)

⚠ CAUTION

The disconnection device (fuse/circuit breaker) rating must support the product's wire cross-section. Observed that wiring and short-circuit/overcurrent protection is performed according to the applicable standards, regulations and the product's electrical specification.

Damage

⚠ CAUTION

Ensure that the power supply and power cables/wires have no visible damage before switching on the product.

Handling the Product

⚠ CAUTION

Operate the product only by trained and skilled personnel within an environment that fulfills all necessary technical and environmental requirements.

Following proper cabling procedure

NOTICE

To prevent a false power-on condition that could result in operational failure ensure that:

- › Make the potential equalization stud connection first and disconnect last.
 - › The last connection made to the product is the power.
-

NOTICE**Minimize Cable Strain**

Support the power and I/O cables to minimize the strain on the product's connectors.

NOTICE**Do not Disconnect the Power Cable During Operation**

Performing a forced shut down can lead to loss of data or other undesirable effects! To shutdown without data loss, use the power button.

9.2. Connecting to the Power Connector

The necessary items required to connect the product to power are include in the delivery. The following chapter describes how to connect the various power connector options to a power source.

Figure 21: Power Connectors

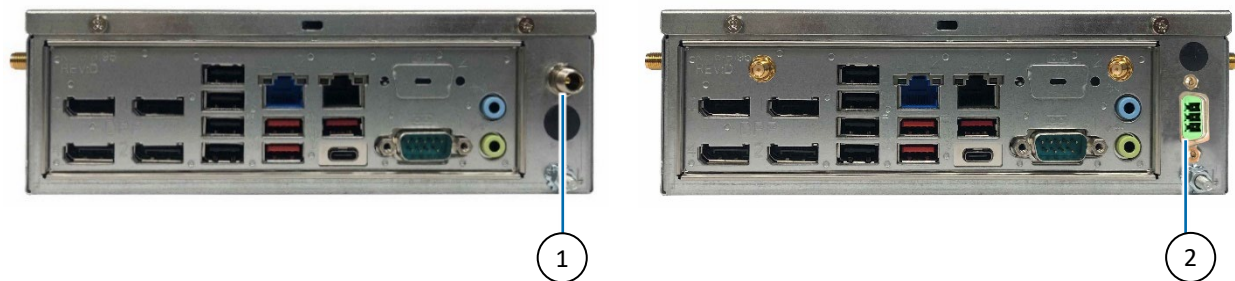

1. 12 VDC DC IN Power Jack (default)
2. 24 VDC DC IN 3-pin connector (option)

9.2.1. 12 VDC DC IN (150 W) Power Jack

The 12 VDC DC IN power jack connects to the external AD/DC 150 W (100/240 VAC/12 VDC) power supply (included in the delivery) that meets the product's electrical specification as stated on the type label and provides the required safety and protection features, see Chapter 12.4: Power Specification.

CAUTION

Only connect the product to the supplied external power supply providing the voltage type (AC or DC) and the input power (max. current) specified on the Kontron Product Label and meeting the requirements of the Limited Power Source (LPS) and Power Source (PS2) of UL/IEC 62368-1.

Figure 22: External AC/DC, (150 W) Power Supply

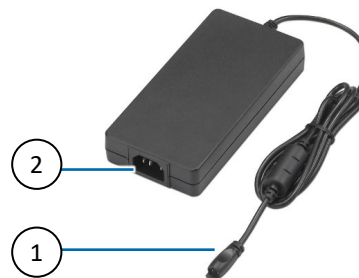

- 1 12 VDC connector
- 2 Mains power cable connector

To connect the supplied external AC/DC (150 W) power supply to the 12 VDC DC IN Power Jack (see Figure 21, pos. 1), perform the following:

1. Ensure the product is closed securely and connect the potential equalization stud to an appropriate common earth connection.
2. Screw the power supply's cable to the 12 VDC DC IN power jack.
3. Connect the other end of the power supply to the mains power outlet using the correct plug for your region.

9.2.2. 24 VDC DC IN 3-pin Power Connector (option)

The 24 VDC DC IN 3-pin power connector connects to the supplied 3-pin mating power connector (PSC 1.5/ 3-F). The external 24 VDC power supply must automatically recover from AC power loss and startup under peak loading.

⚠ CAUTION

Only connect the product to the supplied external power solution providing the voltage type (AC or DC) and the input power (max. current) specified on the Kontron Product Label and meeting the requirements of the Limited Power Source (LPS) and Power Source (PS2) of UL/IEC 62368-1.

Disconnection Device

⚠ CAUTION

The disconnection device (fuse/circuit breaker) rating must support the product's wire cross-section. Observed that wiring and short-circuit/overcurrent protection is performed according to the applicable standards, regulations and the product's electrical specification.



To connect to the 3-pin DC IN power connector only use the 3-pin mating power connector (supplied by Kontron and included in the delivery).

9.2.2.1. Wiring the 3-pin Mating Power Connector

The user is responsible for wiring the product correctly to an external 24 VDC power supply. Kontron recommends marking the wires clearly with (+/-) to ensure the correct connection to the DC IN 3-pin power connector. For the pin assignment of the 24 VDC DC IN 3-pin connector, see Chapter 13.2: DC IN 24 VDC 3-Pin Connector Pin Assignment (option).

Figure 23: 3-pin Mating Power Connector

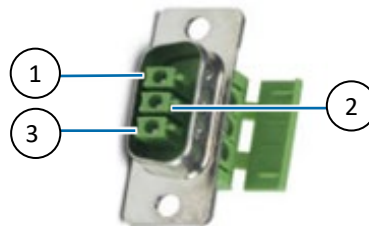

1 +24 VDC wire clamp

3 GND (-) wire clamp

2 NC

NOTICE

Wire the mating power connector clearly by marking the supply wires (+/-) to ensure a safe connection between the 24 VDC DC IN connector and the external 24 VDC power supply.



The wiring is not part of the delivery and must be provided by the user.

- › Use copper wire only if the field wiring terminal is for copper wire connection only.
- › Minimum temperature rating of the field wiring terminals is 75° C.

To wire the supplied 3-pin mating power connector (PSC 1.5/ 3-F) perform the following:

1. Cut three (1 mm²) AWG18 isolated wires to the required length and strip each end 5 mm to 7 mm.
2. Twist the striped wire-ends and provide them with ferrules.
3. Access the slotted pan head screws by opening the mating power connector's cover.
4. Loosen the slotted pan head screws far enough so that you can insert the end of the prepared wires.
5. Insert the wires into the corresponding clamp of the mating power connector. Make sure that you have the right polarity of the connection.
6. Fasten the screws to secure the wires into the mating power connector's clamps.
7. Close the mating power connector's cover.

9.2.2.2. Connecting to an External 24 VDC Power Supply

CAUTION

When connecting the 3-pin mating power connector (PSC 1.5/3-F) to the 24 VDC DC IN connector, securing with the two bolts provided and pay attention to the polarity of the connections.

To connect the 24 VDC DC IN 3-pin connector (see Figure 21, pos. 2) to an external 24 VDC power supply, perform the following:

1. Ensure the product is closed securely and connect the potential equalization stud to an appropriate common earth connection.
2. Wire the supplied 3-pin mating power connector/terminal (PSC 1.5/3-F) as described in Chapter 9.3.1: Wiring the 3-pin Mating Power Connector.
3. Switch off the external 24 VDC power supply via a disconnecting device (fuse/circuit breaker), to ensure that no power flows during the connection procedure.
4. Connect the wired 3-pin mating power connector (PSC 1.5/3-F) to the 3-pin DC IN power connector and secure with the two bolts provided. Pay attention to the polarity of the connections.
5. Connect and secure the other end of the wired 3-pin mating power connector to the external 24 VDC power supply.

9.3. Switching On/Off

To switch on, connect to the power source as described in this user guide, and briefly press the power button. The power button illuminates blue to indicate the switched on state.

To switch off, close all open applications and briefly press the power button. The power button dims to indicate the switched off state. The product is only completely switched off, when the power cable is disconnected from the DC IN power connector or the main power source.

CAUTION

Even when switched off using the power button, parts of the product are still energized. The product is only completely switched off when switched off using the power button and the power cable is disconnected from either the DC IN power connector or the power source.

9.4. Forced Shutdown

Pressing the power button for longer than four seconds initiates a forced system shutdown, before switching off the power. If power is still applied to the DC IN connector, the product restarts by pressing the power button.

NOTICE

Do not disconnect the power cable during operation

Performing a forced shut down can lead to loss of data or other undesirable effects!
To shutdown without data loss, use the power button.

9.5. Operating System (OS) and Hardware Component Drivers

The product supports flexible software options and is supplied with pre-installed OS and all appropriate drivers (according to the ordered hardware configuration) and is fully operational when switched on for the first time.

When ordered without a pre-installed OS, users must install the OS and the appropriate drivers (in accordance with the ordered hardware configuration) before switching on the product for the first time. Pay attention to the manufacturer's OS specifications for integrated hardware components.

For information regarding supported software, see Chapter 12.3: Software Specification.



To download relevant drivers for hardware components, visit Kontron's [Customer Section](#).



Pay attention to the manufacturer OS specifications relating to integrated hardware components.

10/ BIOS

The KBox B-203-RPL uses the AMI Aptio 5.x (uEFI) BIOS supported by the motherboard. This chapter informs users how to start the BIOS, use the BIOS setup to configure, and perform a BIOS update. Note that BIOS features are open to change and may not be available in the latest version of the motherboard's BIOS.



uEFI only! No legacy support and no Master Boot Record (MBR) installation.



Only use the Kontron provided tools!

10.1. Starting the uEFI BIOS

The uEFI BIOS comes with a setup program that provides quick and easy access to the individual function settings for control or modification of the uEFI BIOS configuration. The setup program allows for access to various menus that provide functions or access to sub-menus with further specific functions of their own.

To start the uEFI BIOS setup program, perform the following:

1. Power-up the product.
2. Wait until the first characters appear during the Power On Self-Test (POST) messages or splash screen.
3. Press the or <F2> keys during the POST.
4. If the BIOS is password protected, enter the User Password or Supervisor Password, and press <RETURN> to start the BIOS.
5. The BIOS displays the Main setup menu.



If the or <F2> key is not pressed the POST continues with the test routines.

10.2. BIOS Setup Menus

The uEFI BIOS comes with a setup program that provides quick and easy access to the individual function settings for control or modification of the BIOS configuration. The setup program allows for access to various menus that provide functions or access to sub-menus with further specific functions. At the top of the displayed BIOS screen is the menu bar to the setup menus:

- › Main
- › Advanced
- › H/W Monitor
- › Security
- › Boot
- › Exit

To navigate between the setup menus use the BIOS navigation keys described in Chapter 10.3: BIOS Navigation.



Observe that setting wrong values within the Advanced setup menu may cause the product to operate incorrectly.

10.3. BIOS Navigation

The uEFI BIOS setup program uses a hot key navigation system. The hot key legend bar is located at the bottom of the setup screens. The following table provides a list of navigation hot keys available in the legend bar.

Table 8: Navigation Hot Keys Available in the Legend Bar

Hot Key	Description
<F1>	<F1> key invokes the General Help window
<->	<Minus> key selects the next lower value within a field
<+>	<Plus> key selects the next higher value within a field
<F2>	<F2> key loads previous values
<F3>	<F3> key loads optimized defaults
<F4>	<F4> key Saves and Exits
<→> or <←>	<Left/Right> arrows selects major Setup menus on menu bar, for example, Main or Advanced
<↑> or <↓>	<Up/Down> arrows select fields in the current menu, for example, Setup function or sub-screen
<ESC>	<ESC> key exits a major Setup menu and enters the Exit Setup menu Pressing the <ESC> key in a sub-menu displays the next higher menu level
<RETURN>	<RETURN> key executes a command or selects a submenu

10.4. Updating the BIOS

Before updating the BIOS, Kontron's recommends making a backup of the current BIOS settings. The latest BIOS updates are available in Kontron's [Customer Section](#), within mini-ITX > K3836-Q> Link to FTP server > BIOS information. To update the BIOS perform the instructions as described in the BIOS documentation.



For the latest BIOS updates and BIOS release information, visit Kontron's [Customer Section](#).



During a BIOS update, do not switch off, reset or interrupt the process.
If interrupted, the BIOS update process must be restarted.



After a BIOS update, additional modifications must be made manually.



After a BIOS update If the product fails to boot, the updated BIOS maybe damaged, see Chapter 10.5: Recover BIOS.

Figure 24: BIOS FTP Server Example

kontron

Name	Size	Modified	File Download Link
Approvals_Testreports	-	2024-03-11 13:06:36	-
BIOS	-	2024-03-11 13:06:53	-
Documentation	-	2024-09-11 10:30:21	-
Drivers_ADL.html	91.5 KB	2024-08-13 20:32:02	Download
Mechanics_3D	-	2024-09-18 11:48:54	-
PCN	-	2024-03-11 13:06:37	-

10.5. Recover BIOS

The recover BIOS jumper is located next to the stacked M.2 socket on the motherboard's configuration jumper header.

Figure 25: Configuration Jumper Header

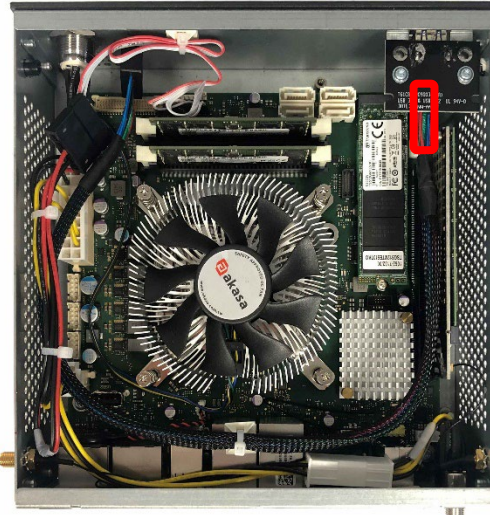

For further motherboard information, visit Kontron's [MITX K3836-Q](https://www.kontron.com/Products/Industrial-PC-Systems/Industrial-PC-Systems-Software/Software-Tools/Software-Tools-Documentation/Software-Tools-Documentation-Documentation) website.



All the BIOS Settings and some data is lost during the BIOS recovery process!

To recover the BIOS using the 'recover BIOS jumper' on the 'configuration header', perform the following:

1. Open the product, as described in Chapter 7.2: Opening the Product, steps 1 to 6.
2. Locate the motherboard's 'configuration header'.
3. Move the 'recover BIOS jumper' from the default position (pins 4 and 5) to the recover position (pins 5 and 6).
4. Do not switch off the product, while the BIOS is recovering.
5. After BIOS recovery, return the 'recover BIOS jumper' to the default position.

Table 9: Configuration Jumper Pin Assignment

Plns	Signal Name	Configuration Jumper
1	Ground	
2	Reserved	
3	BIOS reserved Mode A	
4	BIOS Reserved Mode B	
5	BIOS Recovery -	
6	BIOS Recovery +	

11/ RAID

To support RAID 0/RAID 1 the KBox B-203-RPL must be configured with two M.2 Key M NVMe SSDs modules of the same density.

Table 10: RAID Options

Drive Type	Quantity	Interface	Position	RAID Description
M.2 NVMe SSD	1	PCIe x4	M.2 Key M socket of the stacked M.2 socket	NVMe RAID (software configured)
M.2 NVMe SSD	1	PCIe x4	M.2 Key M socket of the PCIe to M.2 adapter board	NVMe RAID (software configured)



For RAID support the two 2.5" SSDs must have the same density.

12/ Product Specifications

12.1. Block Diagrams

Figure 26: Block Diagram KBox B-203-RPL

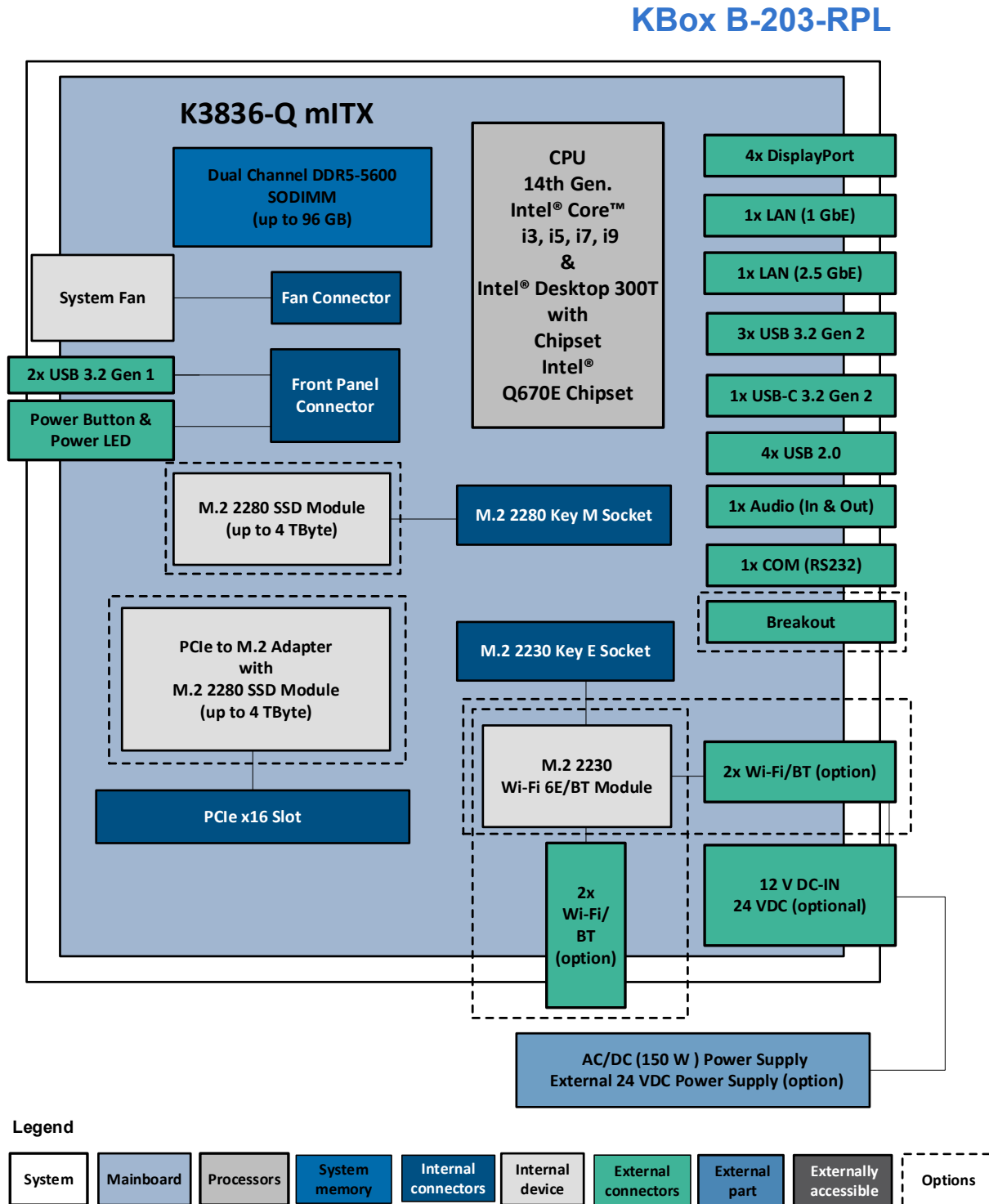

12.2. Hardware Specification

Table 11: Hardware Specification

KBox B-203-RPL		Description
Motherboard	Type	K3836-Q mini-ITX
	Processors	Intel® Core™ processor series i9/i7/i5/i3 (Gen. 14 th) & Intel® Desktop 300T TDP 35 W (max.)
	Chipset	Intel® Q670E
	Graphic	Gen12 UHD Graphics – driven by Xe® architecture (up to 32EU)
	System Memory	2x DDR5 SODIMMs Up to 96 GBytes (with 8 Gbyte, 16 Gbyte, 32 GByte und 48 Gbyte)
Front panel	USB	2x USB 3.2 Gen1
	Button/LED	Power Button with integrated power LED
Rear panel	USB	1x USB-C 3.2 Gen 2, 3x USB 3.2 Gen 2, 4x USB 2.0
	LAN	1x 2.5 GbE (10/100/1000/2500 Mbps), with Intel® i226LM 1x 1 GbE (10/100/1000 Mbps), with Intel® i219LM
	Displays	4 x DP V1.4a @4K
	Audio	Line-In, Line-Out
	COM	1x RS232
	Breakout Panel	1x COM RS232 or 1x S/PDIF Digital audio optical output, supporting 5.1 Multichannel
	Power	12 VDC AC/DC (150 W) PSU (default) 24 VDC connector (option: connects to an external 24 VDC power supply)
Expansion	Internal M.2 socket	1x M.2 2280 Key M SSD 512 GByte, 1 TByte, 2 TByte or 4 TByte Interface: PCIe/NVME
	Internal PCIe slot	1x PCIe to M.2 Adapter board (PCIe x16 Gen 5) 1x M.2 2280 SSD Key M 512 GByte, 1 TByte, 2 TByte or 4 TByte Interface: PCIe/NVME with PCIe to M.2 adapter
	Internal M.2 socket	1x M.2 2230 Key E Wi-Fi 6E (6 GHz), Bluetooth® 5.3 Interface: Wi-Fi: PCIe x1/Bluetooth: USB 2.0

12.3. Software Specification

Table 12: Software Specification

KBox B-203-RPL	Description
Operating System (OS)	Windows® 11 IoT Linux (Debian)
BIOS	AMI Aptio 5.x (UEFI)



UEFI only. No legacy support and no Master Boot Record (MBR) installation.

12.4. Power Specification

The KBox B-203-RPL connects to power using the power solution included in the delivery that meets the product's electrical specification, power consumption, power limitation and power protection requirements.

⚠ CAUTION

For the electrical specification of your product, see Chapter 3.5: Type Label and Product Identification and refer to the product's Type Label.

12.4.1. 12 VDC DC IN Electrical Specification

The 12 VDC DC IN Power Jack connects to the AC/DC 150 W (12 VDC to 100/240 VAC, (50/60 Hz) $\pm 10\%$) power supply, supplied by Kontron in the delivery. The AC/DC 150 W power supply supplies the 12 VDC DC IN power jack with the electrical specification on the product's type label and in Table 13.

Table 13: 12 VDC DC IN Power Jack Electrical Specification

DC IN	Description
Input Voltage	12 VDC
Input Current	9 A (12.5 A max.)
Power Rating	150 W

⚠ CAUTION

Only connect the product to the external AC/DC power supply supplied by Kontron and providing the voltage type (AC or DC) and the input power (max. current) specified on the Kontron Product Label and meeting the requirements of the Limited Power Source (LPS) and Power Source (PS2) of UL/IEC 62368-1.

12.4.2. 24 VDC DC IN Electrical Specification (option)

The 24 VDC DC IN 3-pin power connector option connects to an external 24 VDC power supply supplied by the user, using the 3-pin mating power connector included in the delivery and wired by the user using a suitably rated wiring. The external 24 VDC power supply must automatically recover from AC power loss and startup under peak loading and must supply the 24 VDC DC IN power connector with the electrical specification on the product's type label and in Table 14.

Table 14: 24 VDC DC IN Electrical Specification (option)

DC IN	Description
Input Voltage	24 VDC (Range: 19 VDC to 36 VDC)
Input Current	8.5 A max. (fuse protected)
Power Rating	160 W

⚠ CAUTION

Only connect the product to an external 24 VDC power supply providing the input power (max. current) specified on the Kontron Product Label and meeting the requirements of the Limited Power Source (LPS) and Power Source (PS2) of UL/IEC 62368-1.

⚠ CAUTION

The disconnection device (fuse/circuit breaker) rating must support the product's wire cross-section. Observed that wiring and short-circuit/overcurrent protection is performed according to the applicable standards, regulations and the product's electrical specification.

NOTICE

Ensure that the external 24 VDC power supply is used according to the manufacturer's instructions.

NOTICE

To protect the product and any connected peripherals, make sure that the power cables have the right diameter to withstand the maximum available current.

12.4.3. Power Protection

The AC/DC (150 W) power supply incorporates protection and supply features such as short circuit, over voltage, over temperature and brownout protection. Brownout protection protects the product against fluctuations and interruptions in the delivered mains power supply and help to ensure operation without loss of data or damage to the product.

NOTICE

If there is an unintentional voltage drop in the mains power supply for longer than the specified holdup time (brownout), all supply voltages should be shut down and remain in the off state long enough to allow internal voltages to discharge sufficiently. During the off state time do not disconnect an add cables to/from the I/O connectors. Failure to observe the off state time means that parts of the product or attached peripherals may work incorrectly or suffer a reduction of MTBF.

The minimum off state time, to allow internal voltages to discharge, depends on the power supply used and additional electrical factors. To determine the required off state time, each case must be considered individually. For more information, contact Kontron Support.

12.4.4. Power Consumption

The chosen power supply option must provide the level of power required to meet the product's maximum power consumption. The total power consumption depends on the motherboard capacity, system memory, storage, and system expansion devices and cards. The overall power consumption must not exceed the product's maximum power supply rating.

If the use of system expansion devices/cards increases the total power consumption above the maximum power rating of the power supply, contact [Kontron Support](#).

Table 15: Power Consumption Estimation

KBox B-203-RPL	Power Consumption
Load	TBD
Idel	TBD
Shutdown	TBD

12.4.5. Potential Equalization

The potential equalization stud ensures that all connected systems share a common potential. When connecting cables, always connect the potential equalization stud first.



The potential equalization stud ensures that all connected systems share a common potential.

12.5. Environmental Specification

Table 16: Environmental Specification

KBox B-203-RPL		Description
Temperature (according to IEC 60068-2-2 & IEC 60068-2-1)	Operating	0°C to 50°C (32°F to 122°F)
	Non-operating	-25°C to 70°C (-13°F to 158°F)
Relative Humidity (according to IEC 60068-2-78)	Non-operating	93% RH @ 40°C (104°F), non-condensing
Altitude (according to EN 60068-2-13)	Operating	5,000 m max. (16,400 ft. approx.)
Noise		35 dB (A)
Shock (Operating) (according to IEC 60068-2-27)	Operating	10 g, 11 ms
	Non-operating	30 g, 11 ms
Vibration (Operating) (according to IEC 60068-2-6)	Operating	2 G, 10-150 Hz
	Non-operating	1 G, 10-150 Hz
MTBF		TBD hr.

12.6. Mechanical Specification

Table 17: Mechanical Specification

KBox B-203-RPL		Description
Dimensions (W x H x D)		189.5 mm x 60 mm x 196.5 mm (7.46" x 2.36" x 7.74")
Weight		2 kg (4.4 lbs.) approx.
Chassis		Zinc coated steel sheet
Front Panel		Painted front panel (optional)
Cooling		Fan cooled, axial fan, silent fan
IP Class		IP 20
Mounting	Wall mount bracket (W x H x D)	230 mm x 150 mm x 2 mm (9.06" x 5.91" x 0.08") Screw openings: width 214 mm and depth 120 mm apart
	VESA 100 Mount (W x H x D)	402.86 mm x 180 mm x 11.63 mm (15.86" x 7.09" x 0.46") Screw openings: VESA 100

12.6.1. Dimension Diagrams KBox B-203-RPL

Figure 27: KBox B-203-RPL Dimensions

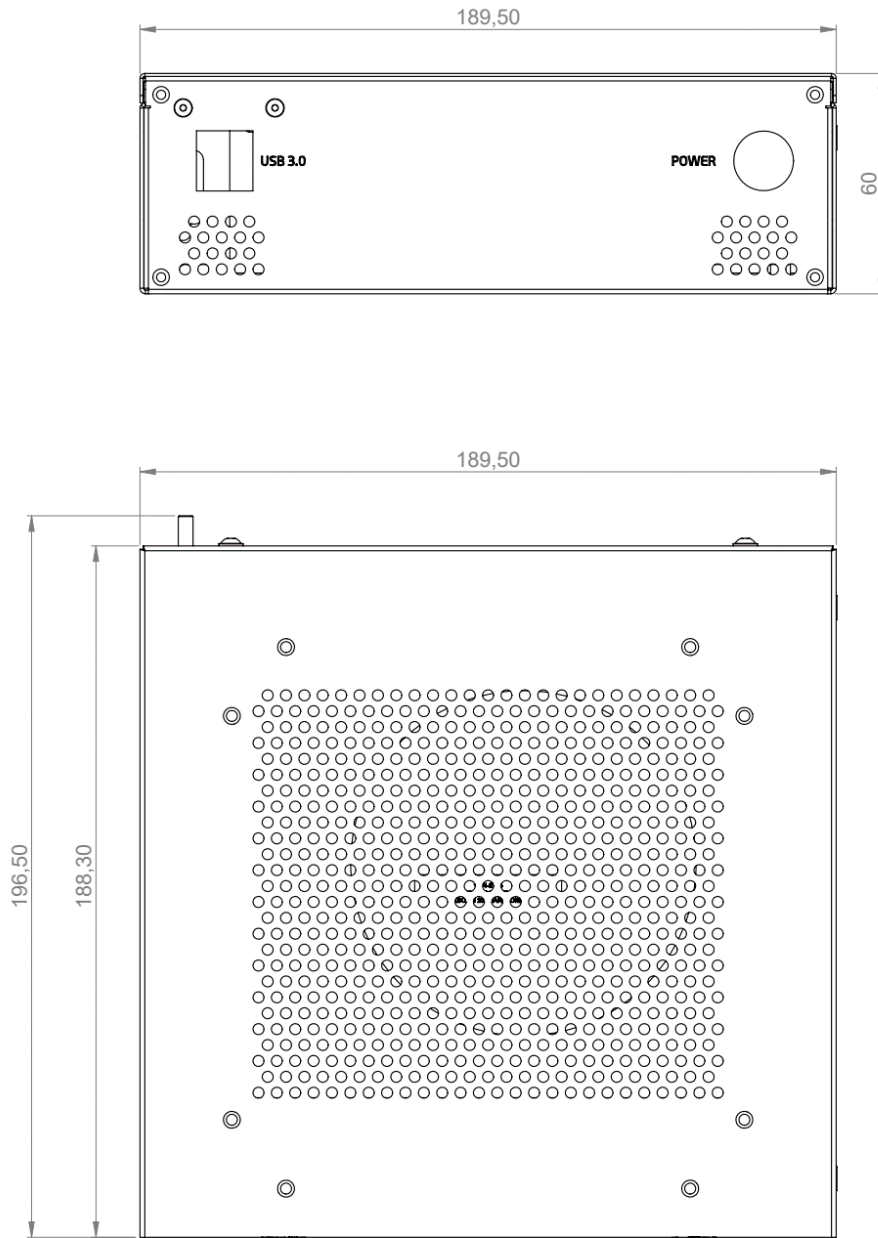

For the products 3D STEP data, visit Kontron's [Customer section](#).

12.6.2. Dimension Diagrams Wall Mount

Figure 28: Wall Mount Dimensions (mm)

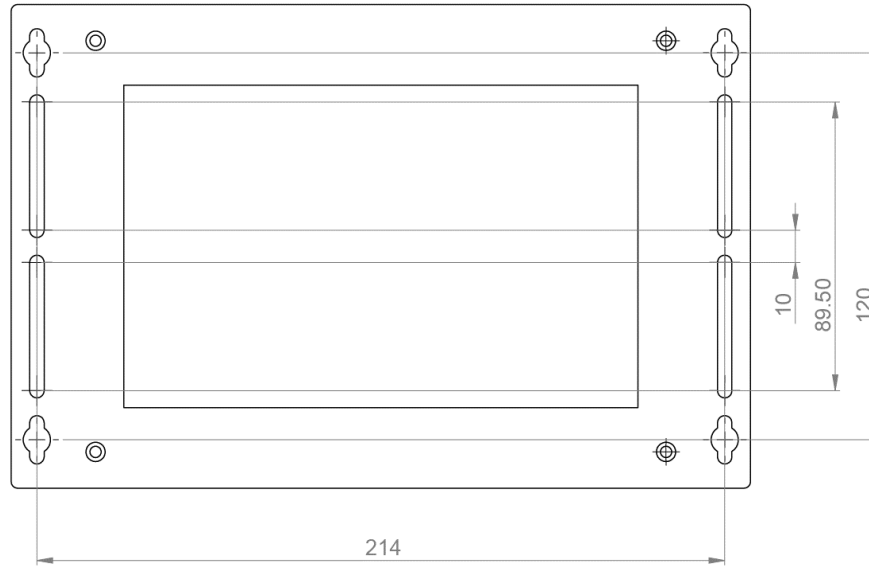

For the products 3D STEP data, visit Kontron's [Customer section](#).

12.6.3. Dimension Diagrams VESA 100 Mount

Figure 29: VESA 100 Mount Dimensions (mm)

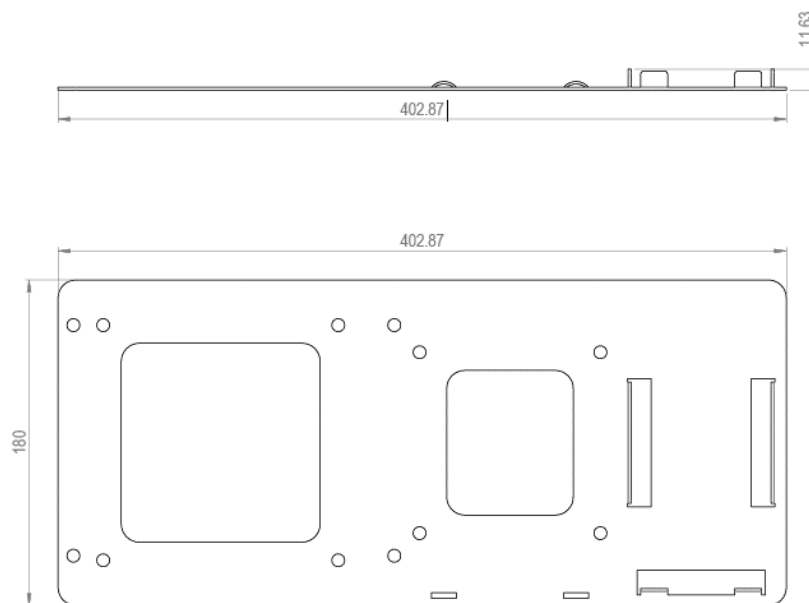

For the products 3D STEP data, visit Kontron's [Customer section](#).

12.7. Compliance

The KBox B-203-RPL **plans to comply** with the relevant requirements and the approximation of the laws relating to the CE Mark for non-Wi-Fi/BT® variants and CE Radio Equipment Directive (RED) for Wi-Fi/BT® variants, and the standards that are constitutional parts of the declaration.

The KBox B-203-RPL **plans to comply** with the following CE certifications.

Table 18: Compliance CE

Europe CE Mark	
Directive	2014/30/EU Electromagnetic compatibility 2014/35/EU Low Voltage 2011/65/EU RoHS II
EMC	EN 55032 Class B Electromagnetic compatibility of multimedia equipment - Emission Requirements Class B device: Requirements for residential environments EN 55035 Electromagnetic compatibility of multimedia equipment - Immunity Requirements EN 61000-6-2 Electromagnetic compatibility (EMC) - Part 6-2: Generic standards - Immunity standard for industrial environments
Safety	EN 62368-1 Audio/video, information and communication technology equipment – Safety requirements

The KBox B-203-RPL **plans to comply** with the following CE RED Mark certifications.

Table 19: Compliance CE RED and United Kingdom

Europe CE RED Mark	
Directives	2014/53/EU Radio Equipment Directive (RED) 2011/65/EU RoHS II
EMC	EN 55032 Class B Electromagnetic compatibility of multimedia equipment - Emission Requirements Class B device: Requirements for residential environments EN 55035 Electromagnetic compatibility of multimedia equipment - Immunity Requirements EN 61000-6-2 Electromagnetic compatibility (EMC) - Part 6-2: Generic standards - Immunity standard for industrial environments ETSI EN 301 489-1 V2.2.3 Electromagnetic Compatibility (EMC) standard for radio equipment and services; Part 1: Common technical requirements

Europe CE RED Mark	
	<p>ETSI EN 301 489-17 V3.2.4 Electromagnetic Compatibility (EMC) standard for radio equipment and services; Part 17: Specific conditions for Broadband Data Transmission Systems</p> <p>ETSI EN 303 446-2 V1.2.1 ElectroMagnetic Compatibility (EMC) standard for combined and/or integrated radio and non-radio equipment - Part 2: Requirements for equipment intended to be used in industrial locations</p>
Radio	<p>ETSI EN 300 328 V2.2.2 Wideband transmission systems - Data transmission equipment operating in the 2,4 GHz band - Harmonised Standard for access to radio spectrum</p> <p>ETSI EN 301 893 V2.1.1 5 GHz RLAN; Harmonised Standard covering the essential requirements of article 3.2 of Directive 2014/53/EU</p> <p>ETSI EN 303 687 V1.0.0 6 GHz WAS/RLAN; Harmonised Standard for access to radio spectrum</p> <p>EN 62311:2008 Assessment of electronic and electrical equipment related to human exposure restrictions for electromagnetic fields (0 Hz - 300 GHz)</p>
Safety	<p>EN 62368-1 Audio/video, information and communication technology equipment – Safety requirements</p>

The KBox B-203-RPL plans to comply with the following international specific certifications.

Table 20: Compliance International

USA/ Canada FCC and NRTL Mark	
EMC	<p>FCC 47 CFR Part 15B and ICES-003 Complies with part 15 FCC rules and regulations of title 47 of the CFR rules for class B products; under which an unintentional radiator may be operated, administrated and other conditions relating to the marketing of part 15 devices.</p>
Safety	<p>UL 62368-1 and CSA-C22.2 No. 62368-1 Audio/video, information and communication technology equipment – Safety requirements</p>

UK UKCA Mark (UK Conformity Assessed)	
Directives	<p>S.I. 2016 No. 1091 Electromagnetic Compatibility Regulations 2016</p> <p>S.I. 2016 No. 1101 Electrical Equipment (Safety) Regulations 2016</p> <p>S.I. 2012 No. 3032 The Restriction of the Use of Certain Hazardous Substances in Electrical and Electronic Equipment Regulations 2012</p> <p>S.I. 2017 No. 1206 Radio Equipment Regulations 201</p>
EMC	CE test reports accepted (see Table 18: Compliance CE)
Safety	CE test reports accepted (see Table 18: Compliance CE)

International (IEC)	
EMC	IEC 61000-6-2 Electromagnetic compatibility (EMC) – Part 6-2: Generic standards – Immunity standard for industrial environments
Safety	IEC 62368-1 Audio/video, information and communication technology equipment – Safety requirement



For the product's Declaration of Conformity (DoC), visit Kontron's [Customer Section](#).



If the product is modified, the prerequisites for specific approvals may no longer apply. Kontron is not responsible for any radio television interference caused by unauthorized modifications of the supplied product or the substitution or attachment of connecting cables and equipment other than those specified by Kontron. The correction of interference caused by unauthorized modification, substitution or attachment is the user's responsibility.



Use shielded I/O cables when connecting to peripheral or host devices. Failure to do so may violate FCC/ICES rules.

13/ Connectors and LEDS



Low-active signals are indicated by a minus sign.

13.1. 12 VDC DC IN Power Jack Pin Assignment (default)

Table 21: 12 VDC DC IN Power Jack Pin Assignment

Pin	Signal Name	Barrel Jack (5.5 mm/ 2.5 mm) with Center Pole
Centre pole	+12 VDC	
Outer ring	Ground	
Mating Power Connector		Power jack on AC/DC 150 W power supply

CAUTION

Power the product with the supplied external AC/DC 150 W power supply only.

13.2. 24 VDC DC IN 3-Pin Connector Pin Assignment (option)

Table 22: 24 VDC DC IN 3-pin Connector Pin Assignment

Pin	Signal Name	3-Pin Phoenix PSC 1.5/3-M
1	24 VDC (+)	
2	NC	
3	Ground (-)	
Mating Power Connector		PSC 1.5/ 3-F (included with the delivery)

CAUTION

When connecting the user wired 3-pin mating power connector (PSC 1.5/3-F) to the DC IN 24 VDC 3-pin power connector and securing with the two bolts provided. Pay attention to the polarity of the connections (Above: +24 VDC & Below: Ground).

CAUTION

Only connect the product to an external 24 VDC power supply providing the input power (max. current) specified on the Kontron Product Label and meeting the requirements of the Limited Power Source (LPS) and Power Source (PS2) of UL/IEC 62368-1.

NOTICE

Mark the supply wires (+/-) clearly to ensure a safe connection from the supplied 3-pin mating power connector to the DC power supply, when using an external 24 VDC power supply.

13.3. USB 3.2 Gen 2/1 Port Pin Assignment

Table 23: USB 3.1 Gen 2/1 Port (Type-A) Pin Assignment

Pin	Signal Name	Pin	Signal name	9-pin USB 3.2 (Type-A) Port
1	+5V	5	RX-	
2	Date-	6	RX+	
3	Data+	7	GND	
4	GND	8	TX-	
		9	TX+	

13.4. USB-C 3.2 Gen 2 Port Pin Assignment

Table 24: USB-C 3.2 Gen 2 Port Pin Assignment

Pin-A	Signal Name	Pin-B	Signal name	9-pin USB 3.2 (Type-A) Port
1	GND	12	GND	
2	USB3_TX1+	11	USB3_RX+	
3	USB3_TX1-	10	USB3_RX1-	
4	VCC	9	VCC	
5	CC1[1]	8	SBU2[2]	
6	USB2_Data1+	7	USB2_Data2-	
7	USB2_Data1-	6	USB2_Data2+	
8	SBU1[2]	5	CC2[1]	
9	VBUS Power	4	VBUS Power	
10	USB3_RX2-	3	USB3_TX2-	
11	USB3_RX2+	2	USB3_TX2+	
12	GND	1	GND	

[1] Configuration channel. Used for USB Power Delivery (PD) communication.

[2] Sideband use



Power delivery not supported.

13.5. USB 2.0 Pin Assignment

Table 25: USB 2.0 Port (Type-A) Pin Assignment

Pin	Signal Name	4-pin USB 2.0 (Type-A) Connector
1	+5 V	
2	Data-	
3	Data+	
4	GND	

13.6. Display Port (DP) V1.4a Pin Assignment

Table 26: Display Port (DP) Connector Pin Assignment

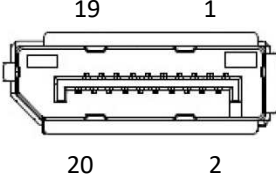
Pin	Signal Name	Pin	Signal name	DP Connector (standard)
1	Link0+	2	GND	
3	Link0-	4	Link1+	
5	GND	6	Link1-	
7	Link2+	8	GND	
9	Link2-	10	Link3+	
11	GND	12	Link3-	
13	DVI dongle detect	14	CEC (not supported)	
15	AUX+	16	GnD	
17	AUX-	18	Hotplug detect	
19	GND (Return)	20	+3.3 V (fuse protected)	

13.7. LAN 2.5 GbE/1 GbE Connector Pin Assignment

Table 27: LAN (2.5 GbE/1 GbE) Connector Pin Assignment

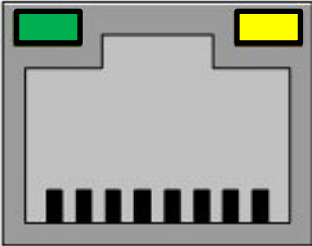
Pin	Signal Name /10/100/1000/2500Mbps)	Signal Name (10/100 Mbps)	RJ45 (female) Connector
1	MX1+	TX+	
2	MX1-	TX-	
3	MX2+	RX+	
4	MX3+		
5	MX3-		
6	MX2-	RX-	
7	MX4+		
8	MX4-		

Link/Activity LED Status (left)	Description	Speed LED Status (right)	Description
Green	Link	Green	2.5 GBE
Green Flashing	Activity	Yellow	1 GBE
		Off	100 Mbps or 10 Mbps

13.8. Audio (Line-In & Line-Out) Connector Pin Assignment

Table 28: Audio (Line-In & Line-Out) Pin Assignment

Jack	Signal Name
Blue	Line input (Line-In)
Green	Headphone output (Line-Out)

13.9. COM Port Pin Assignment (option)

Table 29: COM (RS232) Connector Pin Assignment

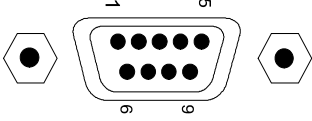
Pin	Signal Name	Pin	Signal name	9-pin D-Sub
1	DCD	6	DSR	
2	RxD	7	RTS	
3	TxD	8	CTS	
4	DTR	9	RI	
5	GND			

13.10. Antenna Wi-Fi/BT® Pin Assignment

Table 30: Antenna Wi-Fi/BT®

Antenna Connector	Description	RP-SMA
Antenna	RP-SMA (female) With center Pin and outer thread	 RP-SMA (female)
Mating Antenna		  RP-SMA (male)

RP-SMA and SMA Antenna are not Interchangeable!

NOTICE

RP-SMA and SMA antenna are not electrically compatible and not interchangeable. Ensure you have use the correct antenna type. If the RP-SMA connector is mixed with an SMA antenna the connector’s center pin may be damaged.



Kontron recommends the use of Kontron’s Wi-Fi/BT® reference antenna chosen to meet RF performance requirements and with a nominal impedance of 50 ohms, see Table 2: List of Accessories.

13.11. S/PDIF Pin Assignment (option)

The two-pole S/PDIF connector connects to a 2 pole coaxial or optical cable.

14/ Maintenance

Kontron products require only minimum servicing and maintenance for problem-free operation. Product maintenance or repair, may only be carried out by skilled personnel authorized by Kontron.

⚠ CAUTION

Handling and operation of the product is permitted only for trained personnel aware of the associated dangers, within a work place that is access controlled and fulfills all necessary technical and environmental requirements.

14.1. Cleaning the Product

NOTICE

Do not use steel wool, metallic threads or solvents like abrasives, alcohol, acetone or benzene when cleaning the product.

NOTICE

When using a damp cloth, only use a mild detergent.

To clean the product's surface, perform the following:

1. Close all applications. Shut down properly using the power button and disconnect the power cable from the DC IN power connector or the power source. Disconnect all peripherals.
2. Allow the product to cool before handling.
3. Remove dust using a clean soft brush.
4. Wipe the product with a soft dry cloth.
5. Remove stubborn dirt using a mild detergent and a soft cloth.

14.2. Replacing Lithium Battery

⚠ CAUTION

Danger of Explosion if the lithium battery is incorrectly placed!

- › Replace only with the same or equivalent type recommended by the manufacturer
- › Dispose of used batteries according to the manufacture's instructions



Do not dispose of lithium batteries in general trash collection. Dispose of the lithium battery according to the local regulations dealing with the disposal of these special materials, (e.g. to the collecting points for dispose of batteries).



The product is not designed to operate without a lithium battery. If the lithium battery is empty or disconnected, the BIOS settings will be set to the factory defaults.

The CR2032 lithium battery must be replaced with an identical three Volt lithium battery or a Kontron recommended lithium battery.

Table 31: Battery Header

Pins	Signal	2-pin BAT header
1	VBAT +	
2	GND	

Table 32: CR2032 Lithium Battery with Connector

Pins	Signal	3V CR2032
Red	+	
Black	-	

Figure 30: CR2032 Lithium Battery and BAT header

1 BAT header on motherboard

2 CR2032 battery with cable

To replace the lithium battery, perform the following:

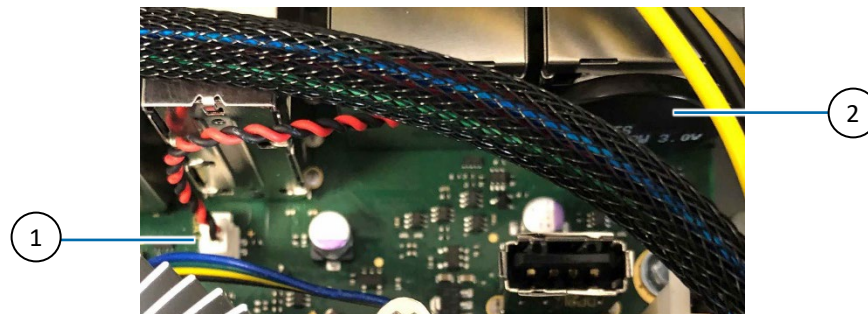
1. Close all applications. Shut down properly using the power button and disconnect the power cable from the DC IN connector or the power source. Disconnect all peripherals.
2. Open the product, see Chapter 7.2: Opening the Product, steps 1 to 6.
3. Remove the lithium battery connector from the BAT header on the motherboard.
4. Pull firmly to detach the adhesive pad on the lithium battery from the Display Port connector's rear side.
5. Insert the new lithium battery connector into the motherboard's BAT header. Ensure correct polarity, see Table 31: Battery Header and Table 32: CR2032 Lithium Battery with Connector.
6. Attach the new lithium battery to the internally Display Port connector with a new adhesive pad.
7. Close the product, see Chapter 7.2: Opening the Product, step 7.

14.3. BIOS Recovery Jumper

To recover the BIOS, refer to Chapter 10.5: Recover BIOS.



All the BIOS settings and some data is lost during the BIOS recovery process!

15/ Storage and Transportation

15.1. Storage

If the product is not in use for an extended period time, disconnect the power plug from the power supply. If it is necessary to store the product then re-pack the product as originally delivered to avoid damage. The storage facility must meet the products environmental storage requirements as stated within this user guide. Kontron recommends keeping the original packaging material for future storage or warranty shipments.

15.2. Transportation

To ship the product use the original packaging, designed to withstand impact and adequately protect the product. When packing or unpacking products always take shock and ESD protection into consideration and use an EOS/ESD safe working area.

16/ Technical Support

For technical support contact our Support Department:

- › E-mail: support@kontron.com
- › Phone: +49-821-4086-888

Make sure you have the following information available when you call:

- › Product ID Number (PN)
- › Serial Number (SN)



The serial number can be found on the Type Label, located on the product's rear panel.

Be ready to explain the nature of your problem to the service technician.

16.1. Returning Defective Merchandise

All equipment returned to Kontron must have a Return of Material Authorization (RMA) number assigned exclusively by Kontron. Kontron cannot be held responsible for any loss or damage caused to the equipment received without an RMA number. The buyer accepts responsibility for all freight charges for the return of goods to Kontron's designated facility. Kontron will pay the return freight charges back to the buyer's location in the event that the equipment is repaired or replaced within the stipulated warranty period. Follow these steps before returning any product to Kontron.

1. Visit the RMA Information website: <https://www.kontron.com/en/support/rma-information>
2. Download the RMA Request sheet for Kontron Europe GmbH and fill out the form. Take care to include a short detailed description of the observed problem or failure and to include the product identification Information (Name of product, Product number and Serial number). If a delivery includes more than one product, fill out the above information in the RMA Request form for each product. Send the completed RMA-Request form to the fax or email address given below at Kontron Europe GmbH. Kontron will provide an RMA-Number.
3. Kontron Europe GmbH
RMA Support
Phone: +49 (0) 821 4086-0
Fax: +49 (0) 821 4086 111
Email: service@kontron.com
4. The goods for repair must be packed properly for shipping, considering shock and ESD protection.



Goods returned to Kontron Europe GmbH in non-proper packaging will be considered as customer caused faults and cannot be accepted as warranty repairs

5. Include the RMA-Number with the shipping paperwork and send the product to the delivery address provided in the RMA form or received from Kontron RMA Support.

17/ Warranty

Due to their limited service life, parts that by their nature are subject to a particularly high degree of wear (wearing parts) are excluded from the warranty beyond that provided by law. This applies to the lithium battery, for example.



If there is a protection label on your product, then the warranty is lost if the product is opened.

18/ Disposal

18.1. Disposal

Disposal of the product in accordance with country, state, or local regulations and requirements as part of your disposition and decommissioning policies or recycle the product or parts of the product for re-use after performing data sanitation to erase the data stored on the product.

When disposing of the product

- › Remove any product labels from the product that could indicate ownership and provide a clue to the type of data stored on the memory device.
- › Consider your company's environmental requirements and the requirements of Waste Electrical and Electronic Equipment (WEEE) directive.
- › Before removing the product from the operating environment, consider if there is data stored on the product that can only be removed securely when the product is connected to power.
- › Use data sanitation guidelines to ensure that data sensitive to your business and/or confidential or proprietary data and software is removed from the product using a data sanitation method that stops the data from being retrieved or reconstructed after deletion or by destruction of the part, see Chapter 17.3: Data Sanitation.

18.2. WEEE Compliance

The Waste Electrical and Electronic Equipment (WEEE) Directive aims to:

- › Reduce waste arising from electrical and electronic equipment (EEE)
- › Make producers of EEE responsible for the environmental impact of their products, especially when the product becomes waste
- › Encourage separate collection and subsequent treatment, reuse, recovery, recycling and sound environmental disposal of EEE
- › Improve the environmental performance of all those involved during the lifecycle of EEE



Environmental protection is a high priority with Kontron.
Kontron follows the WEEE directive
You are encouraged to return our products for proper disposal.

18.3. Data Sanitation

Data sanitation is the process of permanently erasing or destroying sensitive data on the product's memory devices to prevent unauthorized access to data sensitive to your business and/or confidential/proprietary data stored on the memory devices.

When designing a product the user must plan for data sanitation and designing in memory devices that are easier to sanitize, memory devices from manufacturers that provide an effective data erasure tool or memory devices from manufacturers that support a return to factory default command.

When performing data sanitation the user must consider if the product's memory devices contain sensitive data and develop a data sanitation plan to erase all sensitive data in accordance with country, state, or local data sanitation regulations and requirements or as part of your disposal and decommissioning policies.



Data Sanitation

Users are responsible for erasing memory devices in accordance with country, state, or local data sanitization regulations and requirements or as part of your disposition and decommissioning policies.

Kontron recommends performing data sanitation when reusing the product in a different user environment, sending the product in for repair and disposing or decommissioning the product.

General guidelines when performing data sanitation on the product:

- › Before powering down, consider if power is required to perform data sanitation on the product's memory devices. When disconnected from the power source, dismantle all removable memory devices from the product.
- › For memory devices containing data sensitive to your business and/or confidential/proprietary data, use the data sanitation method most suitable for memory device type to be erased. Consider the memory device's volatility. Volatile memory devices only store data temporarily and their data can be erased easily by disconnecting the power/removing the battery for approximately 24 hours. However, non-volatile memory devices store data permanently and retains information when disconnected to power and must be actively erased using an accredited third party software tool or manufacture's data erasure tool or return to factor default command, or destructed.
 - › Use an accredited third party software tool on memory devices. The accredited third party software tool must provide an audit trail, be capable of performing a complete data clean including areas such as hidden data and bad blocks not accessed by general service-based utilities.
 - › Use physically destruction methods on memory devices that cannot be securely software erased. The aim of the destruction is to break the silicon die within the chips package into two or more parts to prevent reading data from the die. Fragments should be no longer than 6 mm. If this service is performed by a third party obtain destruction certificates for confirmation.
 - › Use the manufacture's data erasure tool for sanitization or return to factor default command (if provided by the manufacturer). The manufactures tools and commands have been designed to fulfil the data sanitation requirement of the manufacture's specific memory device(s).
- › Verify that all sensitive data has been effectively sanitized.



Dismantle Removable Memory

Dismantle all removable memory devices from the product. For reuse erase the data using:

- › An accredited third party software tool.
- › Manufacture's data erasure tool' or 'return to factor default command'. (if provided)

If not reused physically destruct the memory device according to data sanitation guidelines.



Erase Data

To ensures that forensic tools cannot be used to recovered data:

- › Use an accredited third party software tool, with an audit trail, capable of performing a complete data clean including areas such as hidden data and bad blocks not accessed by general service- based utilities.
- › Use the manufacture's data erasure tool or return to factor default command designed to fulfil the data sanitation requirement of the manufacture's specific memory device(s).

Physical Destruction



When physically destructing the memory:

- › Follow proper safety protocols.
- › Break the chip packaged silicon die into two or more parts, fragments ≤ 6 mm.
- › Check both sides as memory devices may be position on the rear side.
- › Use a third party destruction company providing destruction certificates for confirmation.

18.4. Statement of Memory Volatility

The product's statement of memory volatility provides the user with a detailed list of the product's memory devices and their volatility, to enable the user to develop a suitable data sanitation plan.

Table 33: Statement of Memory Volatility (Example)

Memory Type	Volatility	Location	Memory Size	Alterable in Field	Battery Backed Up	Data Type	Write Protection	Emergency Erase	Process to Clear
M.2 2280 NVMe SSD ^[1]	Non Volatile	Mainboard	256 GByte 512 GByte 1 Tbyte 3TByte 4 TByte	-	No	Storage	No	No	ATA Secure Erase and/or 3 rd party overwrite data tool
SODIM M DDR5 5600 ^[1]	Volatile	Mainboard	8 Gbyte 16 Gbyte 32 Gbyte 64 Gbyte	-	No	System memory	No	No	Remove from power.

^[1] Memory is an option and may not be included in your configuration.

^[2] in some cases special tools and/or software is necessary to access the memory

19/ Cyber Security

Cyber security is an important aspect to consider when installing, operating, maintaining and disposing the product. This chapter provides cyber security guidelines for the user.



Security White Paper

For cyber security guidelines to protect your Kontron product from potential cyber security threats, refer to Kontron's Security White paper.



Security Measures

Kontron is not aware of the final target end user environment in which the product operates. It is not possible for Kontron to provide precise instructions for your cyber security measures. Kontron strives to provide hints for considerations for your threat analysis and to point out particular security mechanisms implemented in Kontron products.

19.1. Security Defense Strategy

When developing your security defense strategy consider implementing the following guidelines to help you effectively secure the product:

- › Policies and procedures developed in association with the product's/end environment's security.
- › Instructions and recommendations for periodic security maintenance activities and reporting product security incidents.
- › Security network controls/setting such as firewall rules.
- › Third party software tools that further protect the product.
- › Authentication to access the product, limit user privileges and managing user accounts.
- › Data encryption.
- › Reduced number of potential security entry points.
- › BIOS/OS and security updates when available that do not compromise the product's operation or defense in depth strategy.
- › User accounts with length and complexity requirements.
- › Supplied default passwords are changed.
- › Limited network access (IP address range).
- › Installation of anti-virus and malware software.
- › Network access requirements such as VPN.

Appendix: List of Acronyms

AC	Alternating Current
BIOS	Basic Input Output System
BT	Bluetooth
CE	Conformité Européenne
COM	Communication port
DC	Direct Current
DP	Display Port
DPP	Display Port Plus
DVI	Digital Visual Interface
eDP	Embedded Display Port
EEE	Energy Efficient Ethernet
EMC	ElectroMagnetic compatibility
ESD	ElectroStatic Discharge
FCC	Federal Communications Commission
GbE	Giga Bit Ethernet
GND	Ground
GPIO	General Purpose Input Output
HD	High Definition
HDD	Hard Disk Drive
HDMI	High Definition Multimedia Interface
HDR	High Dynamic Range
IOT	Internet of Things
LAN	Local Area Network
LED	Light Emitting Diode
LPS	Limited Power Source
LVDS	Low Voltage Differential Signaling
MBR	Master Boot Record
MDI	Media Dependent Interface
MTBF	Mean Time Before Failure
NVMe	Non Volatile memory Express
OS	Operational System
PS	Power Source
PSU	Power Supply Unit
RAID	Redundant Array of Independent Disks
RMA	Return of Material Authorization
RoHS	Restriction of Hazardous Substances
RTC	Real Time Clock
SATA	Serial ATA
SD Card	Secure Digital Card

SDR	Standard Dynamic Range
SSD	Solid State Drive
S/PDIF	Sony/Philips Digital Interface
TPM	Trusted Platform Module
UEFI	Unified Extensible Firmware Interface
UL	Underwriters Laboratories
USB	Universal Serial Bus
VGA	Video Graphics Array
VESA	Video Electronics Standards Association
WEEE	Waste from Electrical and Electronic Equipment



About Kontron

Kontron is a global leader in IoT/Embedded Computing Technology (ECT) and offers individual solutions in the areas of Internet of Things (IoT) and Industry 4.0 through a combined portfolio of hardware, software and services. With its standard and customized products based on highly reliable state-of-the-art technologies, Kontron provides secure and innovative applications for a wide variety of industries. As a result, customers benefit from accelerated time-to-market, lower total cost of ownership, extended product lifecycles and the best fully integrated applications.

For more information, please visit: www.kontron.com

Global Headquarters

Kontron Europe GmbH

Gutenbergstraße 2
85737 Ismaning, Germany
Tel.: +49 8214 4086-0
info@kontron.com

www.kontron.de

