

## 3.5"-SBC-EKL

Doc. User Guide, Rev. 2.4

Doc. ID: [To be Determined]

This page has been intentionally left blank

 3.5"-SBC-EKL - USER GUIDE

## Disclaimer

Kontron would like to point out that the information contained in this user guide may be subject to alteration, particularly as a result of the constant upgrading of Kontron products. This document does not entail any guarantee on the part of Kontron with respect to technical processes described in the user guide or any product characteristics set out in the user guide. Kontron assumes no responsibility or liability for the use of the described product(s), conveys no license or title under any patent, copyright or mask work rights to these products and makes no representations or warranties that these products are free from patent, copyright or mask work right infringement unless otherwise specified. Applications that are described in this user guide are for illustration purposes only. Kontron makes no representation or warranty that such application will be suitable for the specified use without further testing or modification. Kontron expressly informs the user that this user guide only contains a general description of processes and instructions which may not be applicable in every individual case. In cases of doubt, please contact Kontron.

This user guide is protected by copyright. All rights are reserved by Kontron. No part of this document may be reproduced, transmitted, transcribed, stored in a retrieval system, or translated into any language or computer language, in any form or by any means (electronic, mechanical, photocopying, recording, or otherwise), without the express written permission of Kontron. Kontron points out that the information contained in this user guide is constantly being updated in line with the technical alterations and improvements made by Kontron to the products and thus this user guide only reflects the technical status of the products by Kontron at the time of publishing.

Brand and product names are trademarks or registered trademarks of their respective owners.

©2024 by Kontron Europe GmbH

Kontron Europe GmbH

Gutenbergstraße 2  
85737 Ismaning  
Germany  
[www.kontron.com](http://www.kontron.com)

## Intended Use

**THIS DEVICE AND ASSOCIATED SOFTWARE ARE NOT DESIGNED, MANUFACTURED OR INTENDED FOR USE OR RESALE FOR THE OPERATION OF NUCLEAR FACILITIES, THE NAVIGATION, CONTROL OR COMMUNICATION SYSTEMS FOR AIRCRAFT OR OTHER TRANSPORTATION, AIR TRAFFIC CONTROL, LIFE SUPPORT OR LIFE SUSTAINING APPLICATIONS, WEAPONS SYSTEMS, OR ANY OTHER APPLICATION IN A HAZARDOUS ENVIRONMENT, OR REQUIRING FAIL-SAFE PERFORMANCE, OR IN WHICH THE FAILURE OF PRODUCTS COULD LEAD DIRECTLY TO DEATH, PERSONAL INJURY, OR SEVERE PHYSICAL OR ENVIRONMENTAL DAMAGE (COLLECTIVELY, "HIGH RISK APPLICATIONS").**

You understand and agree that your use of Kontron devices as a component in High Risk Applications is entirely at your risk. To minimize the risks associated with your products and applications, you should provide adequate design and operating safeguards. You are solely responsible for compliance with all legal, regulatory, safety, and security related requirements concerning your products. You are responsible to ensure that your systems (and any Kontron hardware or software components incorporated in your systems) meet all applicable requirements. Unless otherwise stated in the product documentation, the Kontron device is not provided with error-tolerance capabilities and cannot therefore be deemed as being engineered, manufactured or setup to be compliant for implementation or for resale as device in High Risk Applications. All application and safety related information in this document (including application descriptions, suggested safety measures, suggested Kontron products, and other materials) is provided for reference only.

## Revision History

Revision	Brief Description of Changes	Date of Issue	Author/ Editor
1.0	Initial Issue	2022-Nov-18	YS
1.1	Add CAN bus mating connector info	2022-Dec-20	YS
1.2	Update LAN controller	2023-Feb-15	YS
1.3	Add CN20 & CN21 mating connector	2023-Mar-20	YS
1.4	Update BIOS	2023-Mar-24	YS
1.5	Update CN20 & CN21 mating connector	2023-Jun-27	YS
1.6	Add M.2 Key B & Key E installation configuration	2023-Oct-06	YS
2.0	Add FCC & CE standards	2024-Feb-26	YS
2.1	Add power consumption	2024-Mar-27	YS
2.2	Correct the title of Figure 26 & 27	2024-May-29	YS
2.3	Add a note "works only under Linux" to CAN Bus	2024-Jul-09	YS
2.4	Update CAN Bus pin definition	2024-Jul-29	YS

## Terms and Conditions

Kontron warrants products in accordance with defined regional warranty periods. For more information about warranty compliance and conformity, and the warranty period in your region, visit <https://www.kontron.com/terms-and-conditions>.

Kontron sells products worldwide and declares regional General Terms & Conditions of Sale, and Purchase Order Terms & Conditions. Visit <https://www.kontron.com/terms-and-conditions>.

For contact information, refer to the corporate offices contact information on the last page of this user guide or visit our website [CONTACT US](#).

## Customer Support

Find Kontron contacts by visiting: <https://www.kontron.com/support>.

## Customer Service

As a trusted technology innovator and global solutions provider, Kontron extends its embedded market strengths into a services portfolio allowing companies to break the barriers of traditional product lifecycles. Proven product expertise coupled with collaborative and highly-experienced support enables Kontron to provide exceptional peace of mind to build and maintain successful products.

For more details on Kontron's service offerings such as: enhanced repair services, extended warranty, Kontron training academy, and more visit <https://www.kontron.com/support-and-services/services>.

## Customer Comments

If you have any difficulties using this user guide, discover an error, or just want to provide some feedback, contact [Kontron support](#). Detail any errors you find. We will correct the errors or problems as soon as possible and post the revised user guide on our website.



## Symbols

The following symbols may be used in this user guide

### **⚠ DANGER**

DANGER indicates a hazardous situation which, if not avoided, will result in death or serious injury.

### **⚠ WARNING**

WARNING indicates a hazardous situation which, if not avoided, could result in death or serious injury.

### **NOTICE**

NOTICE indicates a property damage message.

### **⚠ CAUTION**

CAUTION indicates a hazardous situation which, if not avoided, may result in minor or moderate injury.



Electric Shock!

This symbol and title warn of hazards due to electrical shocks (> 60 V) when touching products or parts of products. Failure to observe the precautions indicated and/or prescribed by the law may endanger your life/health and/or result in damage to your material.



ESD Sensitive Device!

This symbol and title inform that the electronic boards and their components are sensitive to static electricity. Care must therefore be taken during all handling operations and inspections of this product in order to ensure product integrity at all times.



HOT Surface!

Do NOT touch! Allow to cool before servicing.



Laser!

This symbol informs of the risk of exposure to laser beam and light emitting devices (LEDs) from an electrical device. Eye protection per manufacturer notice shall review before servicing.



This symbol indicates general information about the product and the user guide.

This symbol also indicates detail information about the specific product configuration.



This symbol precedes helpful hints and tips for daily use.

## For Your Safety

Your new Kontron product was developed and tested carefully to provide all features necessary to ensure its compliance with electrical safety requirements. It was also designed for a long fault-free life. However, the life expectancy of your product can be drastically reduced by improper treatment during unpacking and installation. Therefore, in the interest of your own safety and of the correct operation of your new Kontron product, you are requested to conform with the following guidelines.

### High Voltage Safety Instructions

As a precaution and in case of danger, the power connector must be easily accessible. The power connector is the product's main disconnect device.

#### **CAUTION**

##### Warning

All operations on this product must be carried out by sufficiently skilled personnel only.

#### **CAUTION**



##### Electric Shock!

Before installing a non hot-swappable Kontron product into a system always ensure that your mains power is switched off. This also applies to the installation of piggybacks. Serious electrical shock hazards can exist during all installation, repair, and maintenance operations on this product. Therefore, always unplug the power cable and any other cables which provide external voltages before performing any work on this product.

Earth ground connection to vehicle's chassis or a central grounding point shall remain connected. The earth ground cable shall be the last cable to be disconnected or the first cable to be connected when performing installation or removal procedures on this product.

### Special Handling and Unpacking Instruction

#### **NOTICE**



##### ESD Sensitive Device!

Electronic boards and their components are sensitive to static electricity. Therefore, care must be taken during all handling operations and inspections of this product, in order to ensure product integrity at all times.

Do not handle this product out of its protective enclosure while it is not used for operational purposes unless it is otherwise protected.

Whenever possible, unpack or pack this product only at EOS/ESD safe work stations. Where a safe work station is not guaranteed, it is important for the user to be electrically discharged before touching the product with his/her hands or tools. This is most easily done by touching a metal part of your system housing.

It is particularly important to observe standard anti-static precautions when changing piggybacks, ROM devices, jumper settings etc. If the product contains batteries for RTC or memory backup, ensure that the product is not placed on conductive surfaces, including anti-static plastics or sponges. They can cause short circuits and damage the batteries or conductive circuits on the product.



## Lithium Battery Precautions

If your product is equipped with a lithium battery, take the following precautions when replacing the battery.

### **CAUTION**

**Danger of explosion if the battery is replaced incorrectly.**

- ▶ Replace only with same or equivalent battery type recommended by the manufacturer.
- ▶ Dispose of used batteries according to the manufacturer's instructions.

## General Instructions on Usage

In order to maintain Kontron's product warranty, this product must not be altered or modified in any way. Changes or modifications to the product, that are not explicitly approved by Kontron and described in this user guide or received from Kontron Support as a special handling instruction, will void your warranty.

This product should only be installed in or connected to systems that fulfill all necessary technical and specific environmental requirements. This also applies to the operational temperature range of the specific board version that must not be exceeded. If batteries are present, their temperature restrictions must be taken into account.

In performing all necessary installation and application operations, only follow the instructions supplied by the present user guide.

Keep all the original packaging material for future storage or warranty shipments. If it is necessary to store or ship the product then re-pack it in the same manner as it was delivered.

Special care is necessary when handling or unpacking the product. See Special Handling and Unpacking Instruction.

## Quality and Environmental Management

Kontron aims to deliver reliable high-end products designed and built for quality, and aims to complying with environmental laws, regulations, and other environmentally oriented requirements. For more information regarding Kontron's quality and environmental responsibilities, visit <https://www.kontron.com/about-kontron/corporate-responsibility/quality-management>.

## Disposal and Recycling

Kontron's products are manufactured to satisfy environmental protection requirements where possible. Many of the components used are capable of being recycled. Final disposal of this product after its service life must be accomplished in accordance with applicable country, state, or local laws or regulations.

## WEEE Compliance

The Waste Electrical and Electronic Equipment (WEEE) Directive aims to:

- ▶ Reduce waste arising from electrical and electronic equipment (EEE)
- ▶ Make producers of EEE responsible for the environmental impact of their products, especially when the product become waste
- ▶ Encourage separate collection and subsequent treatment, reuse, recovery, recycling and sound environmental disposal of EEE
- ▶ Improve the environmental performance of all those involved during the lifecycle of EEE



**Environmental protection is a high priority with Kontron.**

**Kontron follows the WEEE directive**

**You are encouraged to return our products for proper disposal.**

# Table of Contents

<b>Symbols</b> .....	<b>7</b>
<b>For Your Safety</b> .....	<b>8</b>
High Voltage Safety Instructions .....	8
Special Handling and Unpacking Instruction .....	8
Lithium Battery Precautions .....	9
<b>General Instructions on Usage</b> .....	<b>9</b>
<b>Quality and Environmental Management</b> .....	<b>9</b>
Disposal and Recycling .....	9
WEEE Compliance .....	9
<b>Table of Contents</b> .....	<b>10</b>
<b>List of Tables</b> .....	<b>11</b>
<b>List of Figures</b> .....	<b>12</b>
<b>1/ Introduction</b> .....	<b>15</b>
<b>2/ Installation Procedures</b> .....	<b>16</b>
2.1. Installing the Board .....	16
2.2. Chassis Safety Standards .....	17
2.3. Lithium Battery Replacement .....	17
<b>3/ System Specifications</b> .....	<b>18</b>
3.1. System Block Diagram .....	18
3.2. Component Main Data .....	19
3.3. Environmental Conditions .....	20
3.4. Standards and Certifications .....	20
3.5. Processor Support .....	22
3.6. System Memory Support .....	22
3.6.1. Memory Operating Frequencies .....	22
3.7. On-board Graphics Subsystem .....	23
3.8. Power Supply Voltage .....	23
3.9. Power Consumption .....	23
<b>4/ Connector Locations</b> .....	<b>25</b>
4.1. Top Side .....	25
4.2. Rear Side .....	27
4.3. Connector Panel Side .....	28
<b>5/ Connector Definitions</b> .....	<b>29</b>
<b>6/ I/O-Area Connectors</b> .....	<b>30</b>
6.1. DP Connector (CN24 & CN25) .....	30
6.2. Ethernet Connectors (CN18 & CN19) .....	31
6.3. USB Connectors (I/O Area) .....	32
6.4. Power Button (SW1) .....	34
6.5. LED Indicators (LED1 & LED2) .....	34
<b>7/ Internal Connectors</b> .....	<b>35</b>
7.1. Power Connector .....	35
7.1.1. Power Input Wafer (CN12) .....	35
7.1.2. RTC Power Input Wafer (CN16) .....	36
7.2. Fan Wafer (CN3) .....	37
7.3. SATA (Serial ATA) Connector (CN13) .....	38
7.4. SATA Power Output Wafer (CN10) .....	39

7.5. USB Connectors (Internal) (CN20 & CN21).....	40
7.6. Audio AMP Output Wafer (CN1 & CN4).....	41
7.7. Audio Input / Output Header (CN5).....	42
7.8. Front Panel Header (FP1 & FP2).....	43
7.9. Serial COM1 & COM2 Ports (CN30 & CN29).....	45
7.10. LVDS Connector (CN32).....	47
7.11. LVDS Backlight Power Wafer (CN31) .....	49
7.12. Digital Input / Output Header (CN27).....	50
7.13. CAN Bus Header (CN26 & CN28).....	51
7.14. I <sup>2</sup> C Wafer (CN7).....	52
7.15. GSPI Wafer (CN2).....	53
7.16. SPI 10-Pins Header (CN14) .....	54
7.17. M.2 Key B 2242 / 2280 Slot (M2B1).....	55
7.18. M.2 Key E 2230 Slot (M2E1) .....	58
7.19. M.2 Key M 2280 Slot (M2M1) .....	62
7.20. Micro SIM Card Holder for M.2 Key B (CN6).....	65
7.21. M.2 Key B / M.2 Key E / M.2 Key M Activity Indicator Header (CN11, CN9 & CN17) .....	66
7.22. B2B Connector (CN15).....	67
7.23. Switches and Jumpers .....	71
7.23.1. LVDS Backlight Enable Voltage Selection (JP1).....	71
7.23.2. AT / ATX Power Mode Selection (JP2).....	72
7.23.3. LVDS Backlight Enable Selection (JP3).....	72
7.23.4. LVDS Panel Power Selection (JP4) .....	73
7.23.5. LVDS Backlight Control Selection (JP5).....	73
7.23.6. Flash Descriptor Security Override Selection (JP6) .....	74
7.23.7. Clear CMOS Selection (JP7).....	74
7.23.8. USB Power Selection (JP8) .....	75
7.23.9. MFG Mode Selection (JP9) .....	75
<b>8/ BIOS.....</b>	<b>76</b>
8.1. Starting the uEFI BIOS .....	76
8.2. Starting the uEFI BIOS .....	77
8.2.1. Main Setup Menu .....	77
8.2.2. Advanced Setup Menu.....	79
8.2.3. Power Setup Menu.....	96
8.2.4. Boot Setup Menu .....	98
8.2.5. Security Setup Menu .....	99
8.2.6. Save & Exit Setup Menu .....	104
<b>Appendix A: List of Acronyms .....</b>	<b>105</b>
About Kontron .....	106

## List of Tables

Table 1: Component Main Data .....	19
Table 2: Environmental Conditions .....	20
Table 3: Standards and Certifications .....	21
Table 4: Processor Support.....	22
Table 5: Memory Operating Frequencies.....	22
Table 6: Triple-displays Configurations .....	23
Table 7: Supply Voltages .....	23
Table 8: Power Consumption.....	24

Table 9: Jumper List.....	25
Table 10: Top Side Internal Connector Pin Assignment.....	26
Table 11: Rear Side Internal Connector Pin Assignment.....	27
Table 12: Connector Panel Side Connector List.....	28
Table 13: Pin Assignment DP Connector CN24, CN25.....	30
Table 14: Pin Assignment Ethernet Connectors CN18, CN19.....	31
Table 15: Pin Assignment USB 3.2 Gen 2 Connectors CN22 - Top & Bottom.....	32
Table 16: Pin Assignment USB 2.0 Connectors CN23 - Top & Bottom.....	32
Table 17: LED Indicators LED1, LED2.....	34
Table 18: Pin Assignment CN12.....	35
Table 19: Pin Assignment CN16.....	36
Table 20: Pin Assignment CN3.....	37
Table 21: Pin Assignment CN13.....	38
Table 22: Pin Assignment CN10.....	39
Table 23: Pin Assignment CN20, CN21.....	40
Table 24: Pin Assignment CN1, CN4.....	41
Table 25: Pin Assignment CN5.....	42
Table 26: Pin Assignment FP1.....	43
Table 27: Pin Assignment FP2.....	43
Table 28: Pin Assignment CN30, CN29.....	45
Table 29: Signal Description.....	45
Table 30: Pin Assignment CN32.....	47
Table 31: Pin Assignment CN31.....	49
Table 32: Pin Assignment CN27.....	50
Table 33: Pin Assignment CN26, CN28.....	51
Table 34: Pin Assignment CN7.....	52
Table 35: Pin Assignment CN2.....	53
Table 36: Pin Assignment CN14.....	54
Table 37: Pin Assignment M2B1.....	55
Table 38: Pin Assignment M2E1.....	58
Table 39: Fixing Bolt Extensions and Fastening Screw.....	60
Table 40: Installation Configuration of M.2 Key B SSD / Expansion Card and / or M.2 Key E Expansion Card.....	61
Table 41: Pin Assignment M2M1.....	62
Table 42: Pin Assignment CN6.....	65
Table 43: Pin Assignment CN11, CN17.....	66
Table 44: Pin Assignment CN9.....	66
Table 45: Pin Assignment CN15.....	67
Table 46: Pin Assignment JP1.....	71
Table 47: Pin Assignment JP2.....	72
Table 48: Pin Assignment JP3.....	72
Table 49: Pin Assignment JP4.....	73
Table 50: Pin Assignment JP5.....	73
Table 51: Pin Assignment JP6.....	74
Table 52: Pin Assignment JP7.....	74
Table 53: Pin Assignment JP8.....	75
Table 54: Pin Assignment JP9.....	75
Table 55: Hotkeys Table.....	76
Table 56: Main Setup Menu Sub-Screens and Functions.....	77
Table 57: List of Acronyms.....	105

## List of Figures

Figure 1: System Block Diagram 3.5"-SBC-EKL.....	18
Figure 2: Top Side.....	25
Figure 3: Rear Side.....	27
Figure 4: Connector Panel Side.....	28

Figure 5: DP Connector CN24, CN25 .....	30
Figure 6: Ethernet Connector CN18, CN19 .....	31
Figure 7: USB 3.2 Gen 2 Connectors CN22 - Top & Bottom .....	32
Figure 8: USB 2.0 Connectors CN23 - Top & Bottom .....	32
Figure 9: USB 2.0 High Speed Cable.....	33
Figure 10: USB 3.2 High Speed Cable.....	33
Figure 11: Power Input Wafer CN12.....	35
Figure 12: RTC Power Input Wafer CN16.....	36
Figure 13: Fan Wafer CN3 .....	37
Figure 14: SATA Connector CN13.....	38
Figure 15: SATA Power Output Wafer CN10.....	39
Figure 16: USB 2.0 Port 4, 5 Pin Header CN20, Port 6, 7 Pin Header CN21.....	40
Figure 17: Audio AMP Output Wafer CN1 (Left Channel), CN4 (Right Channel) .....	41
Figure 18: Audio Input / Output Header CN5.....	42
Figure 19: Front Panel Header 1 FP1.....	43
Figure 20: Front Panel Header 2 FP2 .....	43
Figure 21: Serial COM CN30, CN29.....	45
Figure 22: LVDS Connector CN32.....	47
Figure 23: LVDS Backlight Power Wafer CN31.....	49
Figure 24: Digital Input / Output Header CN27 .....	50
Figure 25: CAN Bus Header CN26, CN28 .....	51
Figure 26: I <sup>2</sup> C Wafer CN7.....	52
Figure 27: GSPI Wafer CN2 .....	53
Figure 28: SPI 10-Pins Header CN14 .....	54
Figure 29: M.2 Key B 2242 / 3042 / 2280 Slot M2B1.....	55
Figure 30: M.2 Key E 2230 Slot M2E1.....	58
Figure 31: Location of M.2 Key B & M.2 Key E Sockets and Fixing Bolts .....	60
Figure 32: M.2 Key M 2280 Slot M2M1 .....	62
Figure 33: Micro SIM Card Holder CN6 .....	65
Figure 34: M.2 Key B / M.2 Key M Activity Indicator Header CN11, CN17 .....	66
Figure 35: M.2 Key E Activity Indicator Header CN9 .....	66
Figure 36: B2B Connector CN15.....	67
Figure 37: Jumper Connector .....	71
Figure 38: LVDS Backlight Enable Voltage Selection JP1.....	71
Figure 39: AT / ATX Power Mode Selection JP2.....	72
Figure 40: LVDS Backlight Enable Selection JP3.....	72
Figure 41: LVDS Panel Power Selection JP4.....	73
Figure 42: LVDS Backlight Control Selection JP5.....	73
Figure 43: Flash Descriptor Security Override Selection JP6 .....	74
Figure 44: Clear CMOS Selection JP7.....	74
Figure 45: USB Power Selection JP8.....	75
Figure 46: MFG Mode Selection JP9 .....	75
Figure 47: BIOS Main Menu Screen System Data and Time .....	78
Figure 48: BIOS Advanced Menu .....	80
Figure 49: BIOS Advanced Menu - Display Configuration.....	81
Figure 50: BIOS Advanced Menu - Super IO Configuration.....	83
Figure 51: BIOS Advanced Menu - Super IO Configuration - Serial Port 1 Configuration.....	83
Figure 52: BIOS Advanced Menu - Super IO Configuration - Serial Port 2 Configuration.....	84
Figure 53: BIOS Advanced Menu - CPU Chipset Configuration .....	86
Figure 54: BIOS Advanced Menu - NVMe Configuration.....	87
Figure 55: BIOS Advanced Menu - SATA Configuration .....	88
Figure 56: BIOS Advanced Menu - USB Configuration.....	89
Figure 57: BIOS Advanced Menu - Trusted Computing.....	90
Figure 58: BIOS Advanced Menu - PSE Configuration.....	91
Figure 59: BIOS Advanced Menu - Network Stack.....	92
Figure 60: BIOS Advanced Menu - H/W Monitor.....	93

Figure 61: BIOS Advanced Menu - H/W Monitor - Smart FAN Configuration.....	93
Figure 62: BIOS Advanced Menu - DIO Configuration.....	95
Figure 63: BIOS Power Setup Menu .....	96
Figure 64: BIOS Power Setup Menu - WatchDog Timer Configuration .....	97
Figure 65: BIOS Boot Setup Menu.....	98
Figure 66: BIOS Security Setup Menu .....	99
Figure 67: BIOS Security Setup Menu - Secure Boot .....	100
Figure 68: BIOS Security Setup Menu - Secure Boot - Key Management.....	101
Figure 69: BIOS Save & Exit Setup Menu .....	104

# 1/ Introduction

This user guide describes the 3.5"-SBC-EKL board made by Kontron. This board will also be denoted 3.5"-SBC-EKL within this user guide.

Use of this user guide implies a basic knowledge of PC-AT hardware and software. This user guide focuses on describing the 3.5"-SBC-EKL board's special features and is not intended to be a standard PC-AT textbook.

New users are recommended to study the short installation procedure stated in the following chapter before switching on the power.

All configuration and setup of the CPU board is either carried out automatically or manually by the user via the BIOS setup menus.

Latest revision of this user guide, datasheet, thermal simulations, BIOS, drivers, BSP's (Board Support Packages), mechanical drawings (2D and 3D) can be downloaded from Kontron's Web Page.

## 2/ Installation Procedures

### 2.1. Installing the Board

#### NOTICE



#### ESD Sensitive Device!

Electrostatic discharge (ESD) can damage equipment and impair electrical circuitry.

- ▶ Wear ESD-protective clothing and shoes
- ▶ Wear an ESD-preventive wrist strap attached to a good earth ground
- ▶ Check the resistance value of the wrist strap periodically (1 MΩ to 10 MΩ)
- ▶ Transport and store the board in its antistatic bag
- ▶ Handle the board at an approved ESD workstation
- ▶ Handle the board only by the edges

To get the board running follow these steps. If the board shipped from KONTRON already has components like RAM and CPU cooler mounted, then skip the relevant steps below.

#### 1. Turn off the PSU (Power Supply Unit)

#### NOTICE

Turn off PSU (Power Supply Unit) completely (no mains power connected to the PSU) or leave the Power Connectors unconnected while configuring the board. Otherwise, components (RAM, LAN cards etc.) might get damaged. Make sure to use +12 V DC single supply only with suitable cable kit and PS-ON# active.

#### NOTICE

The power supply unit shall comply with the requirements as defined in IEC 62368-1 according Clause 6.2.2 to power source category PS2 "Limited Power Source".

#### 2. Insert the DDR4 3200 module(s)

Be careful to push the memory module(s) in the slot(s) before locking the tabs.

#### 3. Connecting interfaces

Insert all external cables for hard disk, keyboard etc. A monitor must be connected in order to change BIOS settings.

#### 4. Connect and turn on PSU

Connect PSU to the board by the +12 V 3.0 mm pitch 1x4-pin wafer connector.

#### 5. BIOS setup

Enter the BIOS setup by pressing the <DEL> key during boot up.

Enter "Exit Menu" and Load Setup Defaults.



To clear all BIOS setting, including Password protection, activate "Clear CMOS Jumper" for 10 sec (without power connected).

#### 6. Mounting the board in chassis

#### NOTICE

When mounting the board to chassis etc. please note that the board contains components on both sides of the PCB that can easily be damaged if board is handled without reasonable care. A damaged component can result in malfunction or no function at all.

When fixing the board on a chassis, it is recommended to use screws with an integrated washer and a diameter of > 7 mm. Do not use washers with teeth, as they can damage the PCB and cause short circuits.



## 2.2. Chassis Safety Standards

Before installing the 3.5"-SBC-EKL in the chassis, users must evaluate the end product to ensure compliance with the requirements of the IEC60950-1 safety standard:

- ▶ The board must be installed in a suitable mechanical, electrical and fire enclosure.
- ▶ The system, in its enclosure, must be evaluated for temperature and airflow considerations.
- ▶ The board must be powered by a CSA or UL approved power supply that limits the maximum input current.
- ▶ For interfaces having a power pin such as external power or fan, ensure that the connectors and wires are suitably rated. All connections from and to the product shall be with SELV circuits only.
- ▶ Wires have suitable rating to withstand the maximum available power.
- ▶ The peripheral device enclosure fulfils the IEC60950-1 fire protecting requirements.

## 2.3. Lithium Battery Replacement

If replacing the lithium battery follow the replacement precautions stated in the notification below:

### **CAUTION**

---

**Danger of explosion if the lithium battery is incorrectly replaced.**

- ▶ Replace only with the same or equivalent type recommended by the manufacturer
- ▶ Dispose of used batteries according to the manufacturer's instructions

**VORSICHT! Explosionsgefahr bei unsachgemäßem Austausch der Batterie.**

- ▶ Ersatz nur durch denselben oder einen vom Hersteller empfohlenen gleichwertigen Typ
- ▶ Entsorgung gebrauchter Batterien nach Angaben des Herstellers

**ATTENTION! Risque d'explosion avec l'échange inadéquat de la batterie.**

- ▶ Remplacement seulement par le même ou un type équivalent recommandé par le producteur
- ▶ L'évacuation des batteries usagées conformément à des indications du fabricant

**PRECAUCION! Peligro de explosi3n si la batería se sustituye incorrectamente.**

- ▶ Sustituya solamente por el mismo o tipo equivalente recomendado por el fabricante
- ▶ Disponga las baterías usadas según las instrucciones del fabricante

**ADVARSEL! Lithiumbatteri – Eksplosjonsfare ved feilagtig håndtering.**

- ▶ Udkiftning må kun ske med batteri af samme fabrikat og type
- ▶ Levér det brugte batteri tilbage til leverandøren

**ADVARSEL! Eksplosjonsfare ved feilaktig skifte av batteri.**

- ▶ Benytt samme batteritype eller en tilsvarende type anbefalt av apparatfabrikanten
- ▶ Brukte batterier kasseres i henhold til fabrikantens instruksjoner

**WARNING! Explosionsfara vid felaktigt batteribyte.**

- ▶ Använd samma batterityp eller en ekvivalent typ som rekommenderas av apparattillverkaren
- ▶ Kassera använt batteri enligt fabrikantens instruktion

**VAROITUS! Paristo voi räjähtää, jos se on virheellisesti asennettu.**

- ▶ Vaihda paristo ainoastaan lalteil- mistajan suositteluun tyypin
  - ▶ Hävitä käytetty paristo valmistajan ohjeiden mukaisesti
-

### 3/ System Specifications

#### 3.1. System Block Diagram

Figure 1: System Block Diagram 3.5"-SBC-EKL

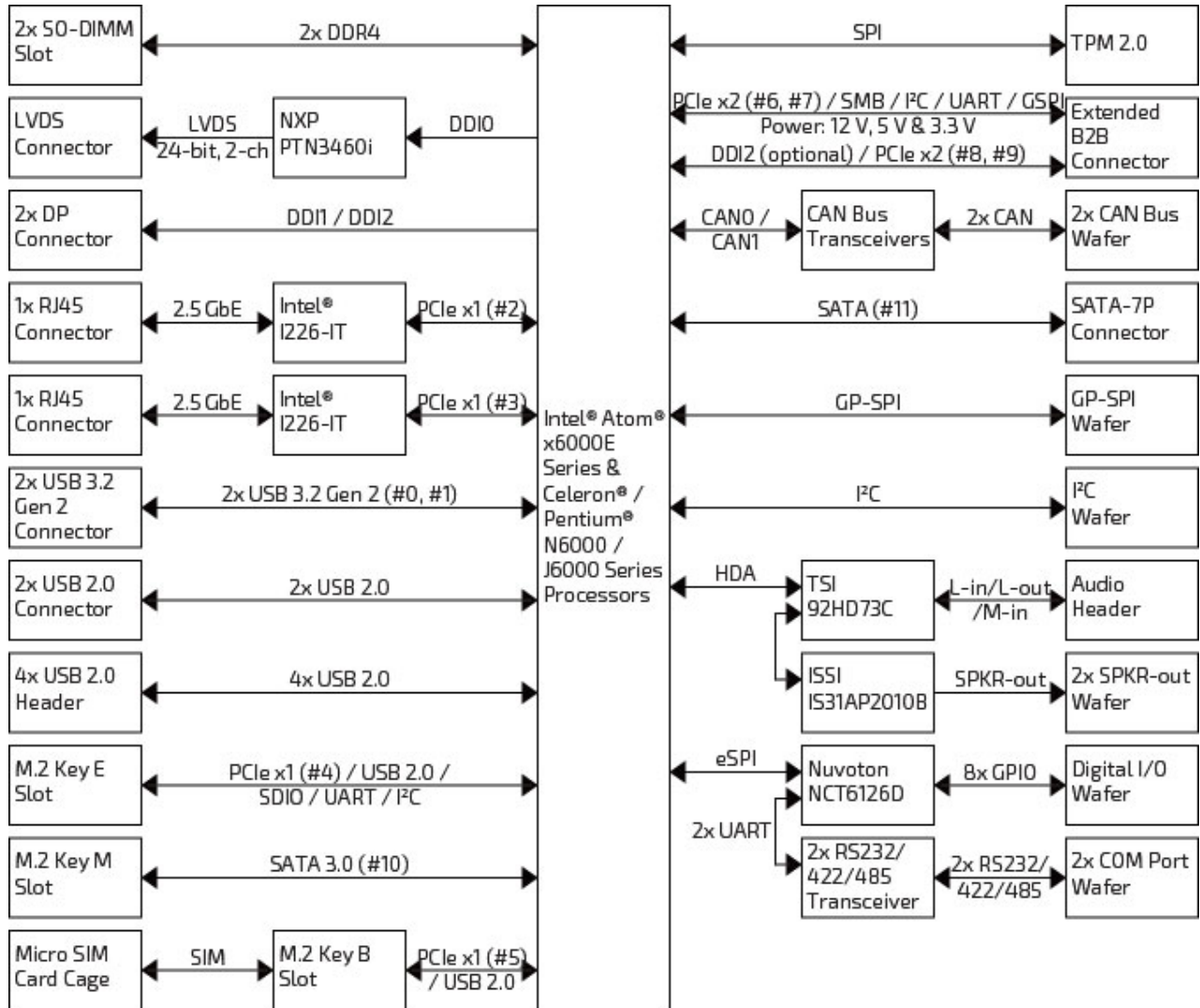

## 3.2. Component Main Data

The table below summarizes the features of the 3.5"-SBC-EKL single board computer.

**Table 1: Component Main Data**

System	
<b>Processor</b>	<ul style="list-style-type: none"> <li>▶ Intel® Atom® x6000E Series Processors</li> <li>▶ Intel® Celeron® J6000 / N6000 Series Processors</li> <li>▶ Intel® Pentium® J6000 / N6000 Series Processors</li> </ul>
<b>Memory</b>	▶ 2x DDR4 SO-DIMM
Video	
<b>Display Interface</b>	<ul style="list-style-type: none"> <li>▶ 1x LVDS</li> <li>▶ 2x DP (on rear, DD12 can support on B2B optionally)</li> </ul>
<b>Multiple Display</b>	▶ Triple
Audio	
<b>Audio Codec</b>	▶ TSI 92HD73C
<b>Audio Display</b>	<ul style="list-style-type: none"> <li>▶ 1x Speaker-out (Stereo, 3 W)</li> <li>▶ 1x Line-in (by header)</li> <li>▶ 1x Line-out (by header)</li> <li>▶ 1x Mic-in (by header)</li> </ul>
Network Connection	
<b>Ethernet</b>	▶ 2x 2.5 GbE LAN (RJ45 on rear, Intel® I226-LM/IT)
Peripheral Connection	
<b>USB</b>	<ul style="list-style-type: none"> <li>▶ 2x USB 3.2 Gen 2 (Type A on rear)</li> <li>▶ 6x USB 2.0 (2x Type A on rear, 4x by header)</li> </ul>
<b>Serial Port</b>	▶ 2x RS232/422/485 (by header)
<b>Other I/Os</b>	<ul style="list-style-type: none"> <li>▶ 8x DIO (by header)</li> <li>▶ 2x CAN Bus (by header, workable only under Linux OS)</li> <li>▶ 1x GP-SPI (by header)</li> <li>▶ 1x I<sup>2</sup>C (by header)</li> </ul>
Storage & Expansion	
<b>SATA</b>	▶ 1x SATA 3.0
<b>M.2</b>	<ul style="list-style-type: none"> <li>▶ 1x M.2 Key B (Type 2242 / 3042 / 2280, mixed w/ PCIe x1 / USB 2.0 / UIM)</li> <li>▶ 1x M.2 Key E (Type 2230, mixed w/ PCIe x1 / USB 2.0 / SDIO / UART / I<sup>2</sup>C)</li> <li>▶ 1x M.2 Key M (Type 2280, mixed w/ SATA 3.0)</li> </ul>
<b>SIM Card Holder</b>	▶ 1x SIM Card Holder (Micro type)
<b>Extended B2B Connector</b>	<ul style="list-style-type: none"> <li>▶ 2x PCIe x2</li> <li>▶ 1x SM Bus</li> <li>▶ 1x I<sup>2</sup>C</li> <li>▶ 1x UART</li> <li>▶ 1x GSPI</li> </ul>

<b>System</b>	
	▶ 1x DDI (optional)
<b>Power</b>	
<b>Input Voltage</b>	▶ DC 12 V
<b>Connector</b>	▶ 1x4-pin pitch 3.0 mm Wafer
<b>Firm ware</b>	
<b>BIOS</b>	▶ AMI uEFI BIOS w/ 256 Mb SPI Flash
<b>Watchdog</b>	▶ Programmable WDT to generate system reset event
<b>H/W Monitor</b>	▶ Voltages ▶ Temperatures
<b>Real Time Clock</b>	▶ SoC integrated RTC
<b>Security</b>	▶ TPM 2.0 (Infineon SLB 9670)
<b>System Control &amp; Monitoring</b>	
<b>Front Panel Header</b>	▶ 1x Header Reset Button, HDD LED & External Speaker ▶ 1x Header for Power Button, Power LED & SM bus
<b>Button, Switch &amp; Indicator</b>	▶ 1x Standby LED (Yellow, on rear) ▶ 1x Power LED (Green, on rear, GPIO controlled) ▶ 1x Power Button (on rear)
<b>Cooling</b>	
<b>Cooling Method</b>	▶ Passive
<b>Software</b>	
<b>OS Support</b>	▶ Windows 10 ▶ Linux
<b>Mechanical</b>	
<b>Dimension (L x W)</b>	▶ ECX (146 mm x 105 mm / 5.75" x 4.13")

### 3.3. Environmental Conditions

The 3.5"-SBC-EKL is compliant with the following environmental conditions. It is the customer's responsibility to provide sufficient airflow around each of the components to keep them within the allowed temperature range.

**Table 2: Environmental Conditions**

<b>Operating Temperature</b>	▶ 0 °C ~ 60 °C / 32 °F ~ 140 °F (Standard) ▶ -40 °C ~ 85 °C / -40 °F ~ 185 °F (Extreme)
<b>Storage Temperature</b>	▶ -20 °C ~ 80 °C / -4 °F ~ 176 °F (Standard) ▶ -55 °C ~ 85 °C / -67 °F ~ 185 °F (Extreme)
<b>Humidity</b>	▶ 0 % ~ 95 %

### 3.4. Standards and Certifications

The 3.5"-SBC-EKL meets the following standards and certification tests.

Table 3: Standards and Certifications

<b>CE Class B</b> <b>UKCA</b>	<ul style="list-style-type: none"> <li>▶ EN 55032: 2015 + A11: 2020 Class B</li> <li>▶ BS EN 55032: 2015 + A11: 2020</li> <li>▶ CISPR 32: 2015</li> <li>▶ EN 61000-3-2: 2014</li> <li>▶ EN IEC 61000-3-2: 2019 + A1: 2021</li> <li>▶ EN 61000-3-3: 2013 + A2: 2021</li> <li>▶ BS EN 61000-3-2: 2014</li> <li>▶ BS EN IEC 61000-3-2: 2019 + A1: 2021</li> <li>▶ BS EN 61000-3-3: 2013 + A2: 2021</li> <li>▶ EN 55035: 2017 + A11: 2020</li> <li>▶ BS EN 55035: 2017 + A11: 2020</li> <li>▶ IEC 61000-4-2: 2008</li> <li>▶ IEC 61000-4-3: 2020</li> <li>▶ IEC 61000-4-4: 2012</li> <li>▶ IEC 61000-4-5: 2014 + A1: 2017</li> <li>▶ IEC 61000-4-6: 2013</li> <li>▶ IEC 61000-4-8: 2009</li> <li>▶ IEC 61000-4-11: 2020</li> <li>▶ EN IEC 61000-6-2: 2019</li> <li>▶ EN IEC 61000-6-4: 2019</li> </ul>
<b>FCC Class B</b> <b>ICES Class B</b>	<ul style="list-style-type: none"> <li>▶ 47 CFR FCC Part 15, Subpart B, Class B</li> <li>▶ ICES-003: 2020 Issue 7, Class B</li> <li>▶ ANSI C63.4: 2014</li> <li>▶ ANSI C63.4a: 2017</li> </ul>
<b>UR (UL Recognized)</b> <b>CSA</b>	<ul style="list-style-type: none"> <li>▶ UL 62368-1, 3rd Ed.</li> <li>▶ CSA C22.2 No. 62368-1:19, 3rd Ed.</li> </ul>

### 3.5. Processor Support

The 3.5"-SBC-EKL is designed to support Intel® Atom® x6000E Series, Intel® Celeron® J6000 / N6000 Series and Intel® Pentium® J6000 / N6000 Series Processors. The BGA CPU is remounted from factory. Kontron has defined the board versions as listed in the following table, so far all based on Embedded CPUs. Other versions are expected at a later date.

**Table 4: Processor Support**

Name	Core #	Speed	Turbo	Embedded	Cache	Socket	TDP	Tj
Intel® Atom® x6211E	2	1.30 GHz	3.00 GHz	Yes	1.5M	FCBGA1493	6 W	105 °C
Intel® Atom® x6212RE	2	1.20 GHz	-	Yes	1.5M	FCBGA1493	6 W	110 °C
Intel® Atom® x6425RE	4	1.90 GHz	-	Yes	1.5M	FCBGA1493	12 W	110 °C
Intel® Celeron® J6413	4	1.80 GHz	3.00 GHz	Yes	1.5M	FCBGA1493	10 W	105 °C

Sufficient cooling must be applied to the CPU in order to remove the effect as listed as TDP (Thermal Design Power) in above table. The sufficient cooling is also depending on the worst case maximum ambient operating temperature and the actual worst case load of processor.

### 3.6. System Memory Support

The 3.5"-SBC-EKL has two DDR4 SO-DIMM sockets. The sockets support the following memory features:

- ▶ 2x DDR4 SO-DIMM 260-pin
- ▶ Dual-channel with 1x SO-DIMM per channel
- ▶ Up to 32 GB
- ▶ SPD timing supported
- ▶ In-band ECC supported (Celeron® excluded)

The installed DDR4 SO-DIMM should support the Serial Presence Detect (SPD) data structure. This allows the BIOS to read and configure the memory controller for optimal performance. If non-SPD memory is used, the BIOS will attempt to configure the memory settings, but performance and reliability may be impacted, or the board may not be able to boot totally.

#### 3.6.1. Memory Operating Frequencies

In all modes, the frequency of system memory is the lowest frequency of all the memory modules placed in the system. Each memory module's frequency can be determined through the SPD registers on the memory modules.

The table below lists the resulting operating memory frequencies based on the combination of SO-DIMMs and processor.

**Table 5: Memory Operating Frequencies**

SO-DIMM Type	Module Name	Memory Data Transfer (MT/s)	Processor System Bus Frequency (MHz)	Resulting Memory Clock Frequency (MHz)	Peak Transfer Rate (MB/s)
DDR4 3200	PC4-25600	3200	1600	400	25600

Memory modules have in general a much lower longevity than embedded motherboards, and therefore EOL of modules can be expected several times during lifetime of the motherboard.

As a minimum it is recommend using Kontron memory modules for prototype system(s) in order to prove stability of the system and as for reference.

For volume production you might request to test and qualify other types of RAM. In order to qualify RAM it is recommend configuring 3 systems running RAM Stress Test program in heat chamber at 60° C for a minimum of 24 hours.

### 3.7. On-board Graphics Subsystem

The 3.5"-SBC-EKL supports Intel® UHD Graphics technology for 10th Gen Intel® processors for high quality graphics capabilities. All 3.5"-SBC-EKL versions support triple displays pipes.

Triple displays can be used simultaneously and be used to implement independent or cloned display configuration.

The 3.5"-SBC-EKL itself provides one internal LVDS interface and two external DP connectors. It can optionally support a DDI (Digital Display Interface) signal via the B2B connector (CN15) by trading off an external DP connector (CN24). The DDI signal can support a DP connector on a daughter board connected to the B2B connector.

**Table 6: Triple-displays Configurations**

Display 1	Display 2	Display 3	Max. Resolution (Px) at 60 Hz		
			Display 1	Display 2	Display 3
LVDS	DP	DP	1920 x 1200	4096 x 2160	4096 x 2160

### 3.8. Power Supply Voltage

In order to ensure safe operation of the board, the input power supply must monitor the supply voltage and shut down if the supply is out of range – refer to the actual power supply specification. Please note, in order to keep the power consumption to a minimal level, boards do not implement a guaranteed minimum load. The 3.5"-SBC-EKL board must be powered through the 3.0 mm pitch 1x4-pin wafer connector from a DC 12 V power supply.

#### **NOTICE**

Hot Plugging power supply is not supported. Hot plugging might damage the board.

The requirements to the supply voltages are as follows:

**Table 7: Supply Voltages**

Supply	Min.	Max.	Note
+12 V	11.4 V	12.6 V	Should be ±5 % tolerance

### 3.9. Power Consumption

The power consumption is measured under the following software and hardware test condition.

- ▶ 3.5"-SBC-EKL with Intel® Atom® x6425RE processor (Quad Core @ 1.90 GHz)
- ▶ Memory: 2x 16 GByte DDR4

- ▶ Storage: 128 GByte Phison 2.5" SATA SSD
- ▶ Operating System: Windows 10 Enterprise LTSC 21H2

The power consumption in different modes is as follows:

**Table 8: Power Consumption**

Mode	Voltage	Power Consumption	
		Peak	Mean
Boot	+12 V	67.2 W	-
Idle (S0)	+12 V	60.96 W	7.044 W
Full Run (S0)	+12 V	20.52 W	12.564 W
Sleep (S3)	+12 V	2.928 W	1.848 W
Shutdown (S4 / S5)	+12 V	2.652 W	1.596 W
Power Saving (ErP / EuP)	+12 V	812.4 mW	86.04 mW



## 4/ Connector Locations

### 4.1. Top Side

Figure 2: Top Side

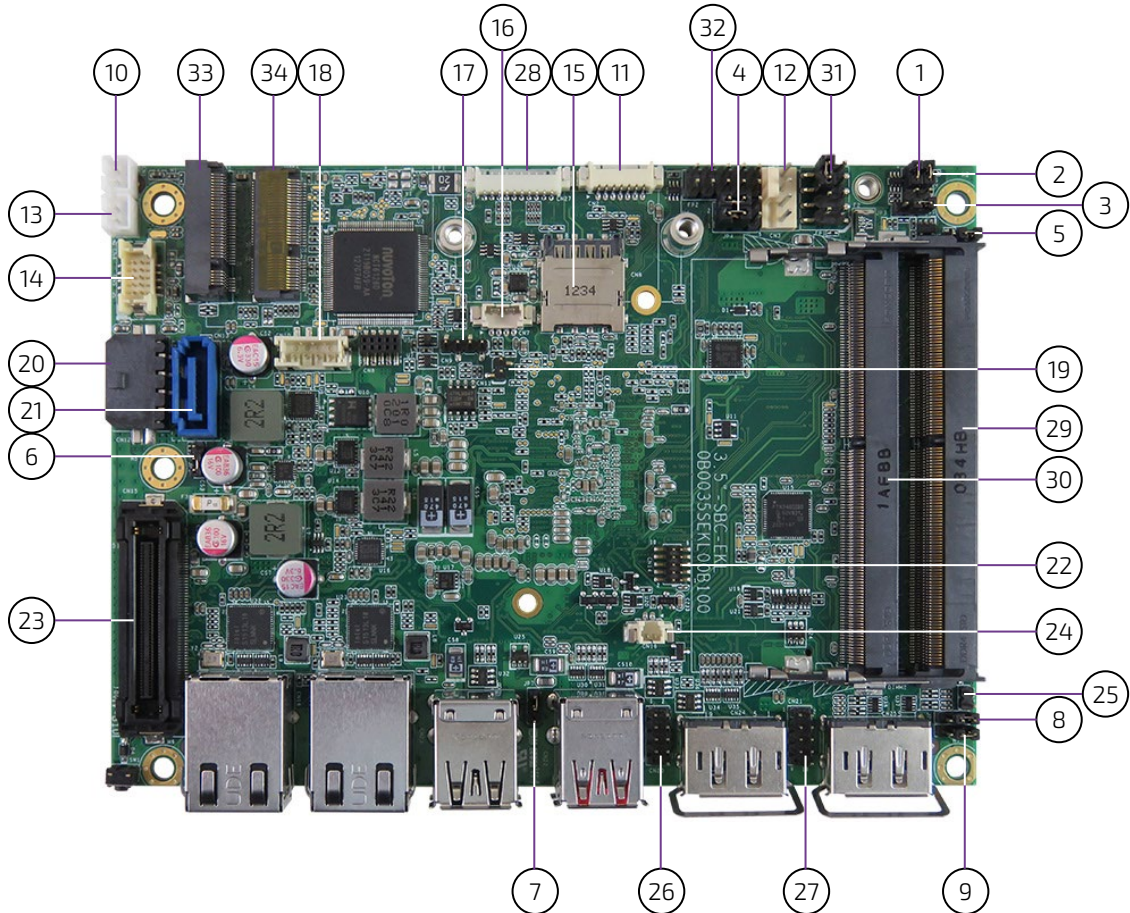

Table 9: Jumper List

Item	Designation	Description	See Chapter
1	JP1	LVDS Backlight Enable Voltage Selection	7.23.1
2	JP2	AT / ATX Power Mode Selection	7.23.2
3	JP3	LVDS Backlight Enable Selection	7.23.3
4	JP4	LVDS Panel Power Selection	7.23.4
5	JP5	LVDS Backlight Control Selection	7.23.5
6	JP6	Flash Descriptor Security Override Selection	7.23.6
7	JP7	Clear CMOS Selection	7.23.7
8	JP8	USB Power Selection	7.23.8
9	JP9	MFG Mode Selection	7.23.9

Table 10: Top Side Internal Connector Pin Assignment

Item	Designation	Description	See Chapter
10	CN1	Left Channel Audio AMP Output Wafer	7.6
11	CN2	GSPI Wafer	7.15
12	CN3	FAN Wafer	7.2
13	CN4	Right Channel Audio AMP Output Wafer	7.6
14	CN5	Audio Input / Output Header	7.7
15	CN6	Micro SIM Card Holder for M2B1	7.20
16	CN7	I <sup>2</sup> C Wafer	7.14
17	CN9	Activity Indicator Header for M2E1	7.21
18	CN10	SATA Power Output Wafer	7.4
19	CN11	Activity Indicator Header for M2B1	7.21
20	CN12	+12 V DC Power Input Wafer	7.1.1
21	CN13	SATA Connector	7.3
22	CN14	SPI 10-Pins Header	7.16
23	CN15	B2B Connector	7.22
24	CN16	RTC Power Input Wafer	7.1.2
25	CN17	Activity Indicator Header for M2M1	7.21
26	CN20	USB 2.0 Port 4 & 5 Header	7.5
27	CN21	USB 2.0 Port 6 & 7 Header	7.5
28	CN27	DIO Header	7.12
29	DIMM1	DDR4 Channel 0 SO-DIMM Slot	3.6
30	DIMM2	DDR4 Channel 1 SO-DIMM Slot	3.6
31	FP1	Front Panel Header 1	7.8
32	FP2	Front Panel Header 2	7.8
33	M2B1	M.2 Key B 2242 / 3042 / 2280 Slot (No SATA)	7.17
34	M2E1	M.2 Key E 2230 Slot	7.18

## 4.2. Rear Side

Figure 3: Rear Side

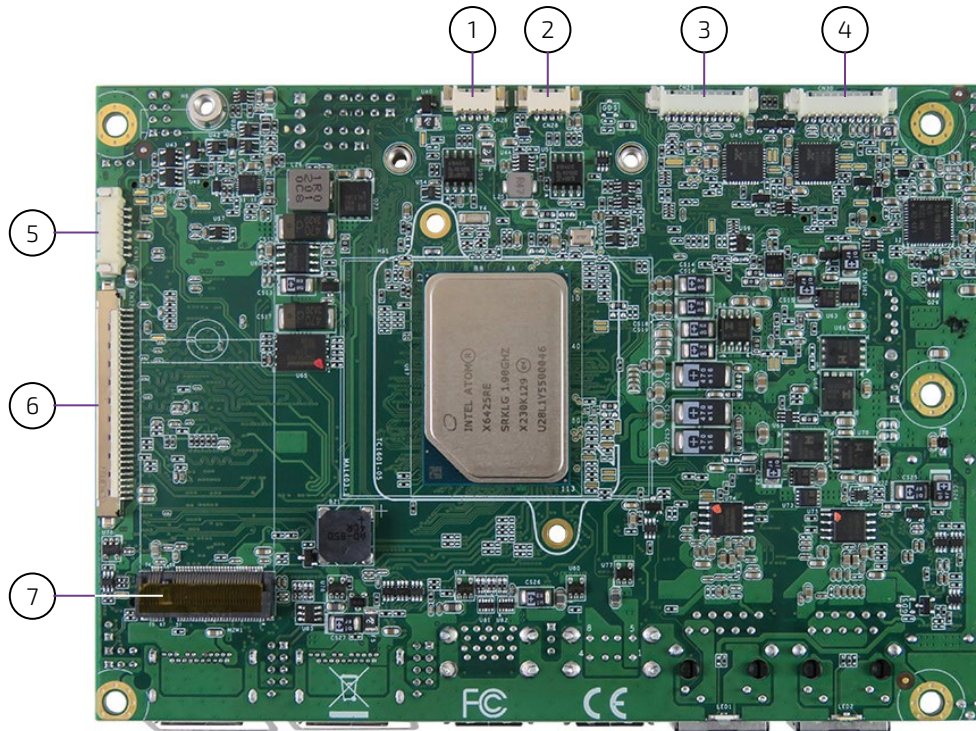

Table 11: Rear Side Internal Connector Pin Assignment

Item	Designation	Description	See Chapter
1	CN26	CAN BUS 0	7.13
2	CN28	CAN BUS 1	7.13
3	CN29	RS232/422/485 COM2 Wafer	7.9
4	CN30	RS232/422/485 COM1 Wafer	7.9
5	CN31	LVDS Backlight Power Wafer	7.11
6	CN32	24-bit / 2-ch LVDS Connector	7.10
7	M2M1	M.2 Key M 2280 Slot (SATA only)	7.19

### 4.3. Connector Panel Side

Figure 4: Connector Panel Side

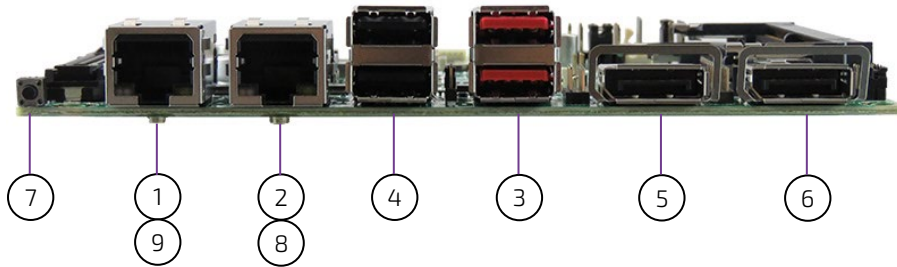

Table 12: Connector Panel Side Connector List

Item	Designation	Description	See Chapter
1	CN18	2.5 GbE LAN1 RJ45 Connector	6.2
2	CN19	2.5 GbE LAN2 RJ45 Connector	6.2
3	CN22	USB 3.2 Gen 2 Port 0, 1 Type A Connector	6.3
4	CN23	USB 2.0 Port 2, 3 Type A Connector	6.3
5	CN24	DP Port 1 Connector	6.1
6	CN25	DP Port 2 Connector	6.1
7	SW1	Power Button	6.4
8	LED1	Standby LED	6.5
9	LED2	Power LED	6.5

## 5/ Connector Definitions

The following defined terms are used within this user guide to give more information concerning the pin assignment and to describe the connector's signals.

Defined Term	Description
Pin	Shows the pin numbers in the connector
Signal	The abbreviated name of the signal at the current pin The notation "XX#" states that the signal "XX" is active low
Note	Special remarks concerning the signal
Designation	Type and number of item described
See Chapter	Number of the chapter within this user guide containing a detailed description

The abbreviation TBD is used for specifications that are not available yet or which are not sufficiently specified by the component vendors.

## 6/ I/O-Area Connectors

### 6.1. DP Connector (CN24 & CN25)

The DP (DisplayPort) connectors are based on standard DP female port.

Figure 5: DP Connector CN24, CN25

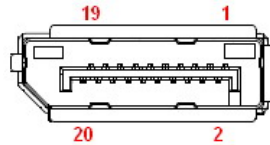

Table 13: Pin Assignment DP Connector CN24, CN25

Pin	Signal	Description	Note
1	ML_Lane0p	DisplayPort Lane 0 transmitter differential pair (+)	
2	GND	Ground	
3	ML_Lane0n	DisplayPort Lane 0 transmitter differential pair (-)	
4	ML_Lane1p	DisplayPort Lane 1 transmitter differential pair (+)	
5	GND	Ground	
6	ML_Lane1n	DisplayPort Lane 1 transmitter differential pair (-)	
7	ML_Lane2p	DisplayPort Lane 2 transmitter differential pair (+)	
8	GND	Ground	
9	ML_Lane2n	DisplayPort Lane 2 transmitter differential pair (-)	
10	ML_Lane3p	DisplayPort Lane 3 transmitter differential pair (+)	
11	GND	Ground	
12	ML_Lane3n	DisplayPort Lane 3 transmitter differential pair (-)	
13	Config1	Connected to ground, either directly or through a pulldown device	
14	Config2	Connected to ground, either directly or through a pulldown device	
15	AUX_CHp	DisplayPort Auxiliary channel differential pair (+)	
16	GND	Ground	
17	AUX_CHn	DisplayPort Auxiliary channel differential pair (-)	
18	Hot_Plug	DisplayPort hot plug detect	
19	GND	Ground	
20	DP_PWR	Power for connector	

## 6.2. Ethernet Connectors (CN18 & CN19)

The 3.5"-SBC-EKL supports two channels of 10/100/1000/2500 Mbit Ethernet, which are based Intel® I226-LM/IT controllers.

In order to achieve the specified performance of the Ethernet port, Category 5 twisted pair cables must be used with 10/100 MByte and Category 5E, 6 or 6E with 1 Gbit/2.5 Gbit LAN networks.

The signals for the Ethernet ports are as follows:

Figure 6: Ethernet Connector CN18, CN19

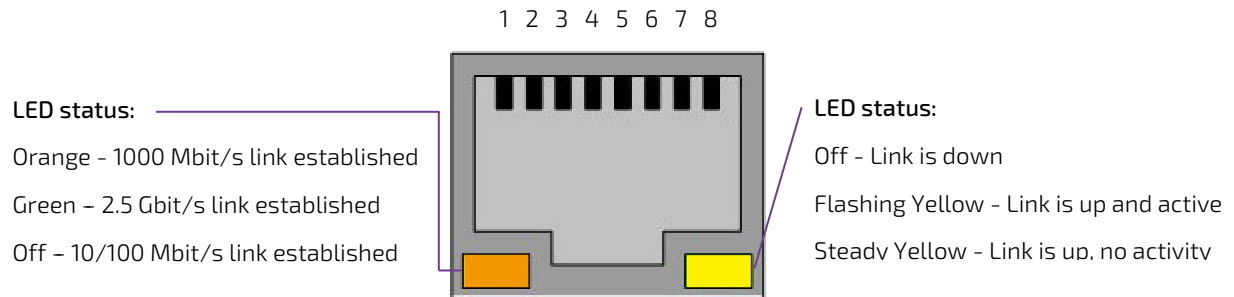

Table 14: Pin Assignment Ethernet Connectors CN18, CN19

Pin	Signal	Note
1	TX1+	
2	TX1-	
3	TX2+	
4	TX3+	
5	TX3-	
6	TX2-	
7	TX4+	
8	TX4-	

### Signal Description

Signal	Description
TX1+ / TX1-	In MDI mode, this is the first pair in 2.5GBase-T and 1000Base-T, i.e. the BI_DA+/- pair, and is the transmit pair in 10Base-T and 100Base-TX. In MDI crossover mode, this pair acts as the BI_DB+/- pair, and is the receive pair in 10Base-T and 100Base-TX.
TX2+ / TX2-	In MDI mode, this is the second pair in 2.5GBase-T and 1000Base-T, i.e. the BI_DB+/- pair, and is the receive pair in 10Base-T and 100Base-TX. In MDI crossover mode, this pair acts as the BI_DA+/- pair, and is the transmit pair in 10Base-T and 100Base-TX.
TX3+ / TX3-	In MDI mode, this is the third pair in 2.5GBase-T and 1000Base-T, i.e. the BI_DC+/- pair. In MDI crossover mode, this pair acts as the BI_DD+/- pair.
TX4+ / TX4-	In MDI mode, this is the fourth pair in 2.5GBase-T and 1000Base-T, i.e. the BI_DD+/- pair. In MDI crossover mode, this pair acts as the BI_DC+/- pair.

'MDI' – media dependent Interface

### 6.3. USB Connectors (I/O Area)

The external I/O connector panel supports one dual USB 3.2 Gen 2 connector (CN22) and one dual USB 2.0 connector (CN23).



USB 3.2 Gen 2 ports are backward compatible with USB 3.2 Gen 1 and USB 2.0.

Figure 7: USB 3.2 Gen 2 Connectors CN22 - Top & Bottom



Table 15: Pin Assignment USB 3.2 Gen 2 Connectors CN22 - Top & Bottom

Pin	Signal	Description	Note
1	+USB_VCC*	+5 V power supply for USB device	
2	USB_D-	USB 2.0 differential pair (-)	
3	USB_D+	USB 2.0 differential pair (+)	
4	GND	Ground	
5	USB_RX-	USB 3.2 receiver differential pair (-)	
6	USB_RX+	USB 3.2 receiver differential pair (+)	
7	GND	Ground	
8	USB_TX-	USB 3.2 transmitter differential pair (-)	
9	USB_TX+	USB 3.2 transmitter differential pair (+)	



\* The power source of +USB\_VCC can be selected through JP8.

Figure 8: USB 2.0 Connectors CN23 - Top & Bottom

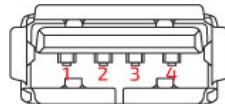

Table 16: Pin Assignment USB 2.0 Connectors CN23 - Top & Bottom

Pin	Signal	Description	Note
1	+USB_VCC*	+5 V power supply for USB device	
2	USB_D-	USB 2.0 differential pair (-)	
3	USB_D+	USB 2.0 differential pair (+)	
4	GND	Ground	





\* The power source of +USB\_VCC can be selected through JP8.

For HiSpeed rates it is required to use a USB cable, which is specified in USB 2.0 standard:

Figure 9: USB 2.0 High Speed Cable

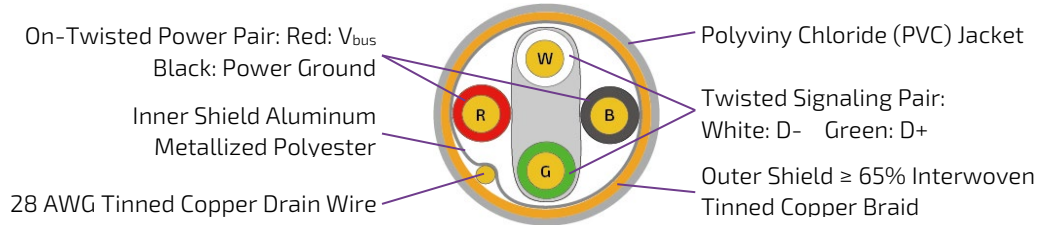

For USB 3.2 Gen 2 cabling it is required to use only HiSpeed USB cable, specified in USB 3.2 standard:

Figure 10: USB 3.2 High Speed Cable

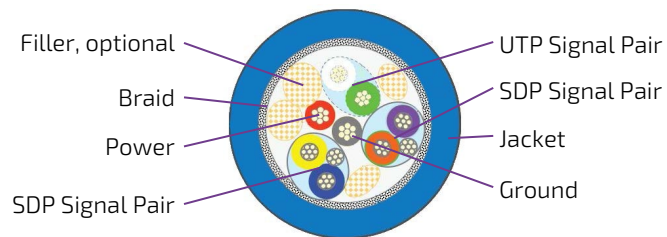

## 6.4. Power Button (SW1)

The external I/O connector panel supports a power button (SW1) for turning on and off the board.

## 6.5. LED Indicators (LED1 & LED2)

The external I/O connector panel supports one power LED indicator (LED2) and one standby LED indicator (LED1) for power and standby status indication.

**Table 17: LED Indicators LED1, LED2**

LED Status		Description
Power LED (LED2)	Standby LED (LED1)	
Green LED On	Yellow LED On	S0 (Full On)
Green LED Blink	Yellow LED On	S3 (Suspend-To-RAM)
LED Off	Yellow LED On	S4 (Suspend-To-Disk) or S5 (Soft Off)
LED Off	LED Off	EUP Mode or G3 (Mechanical Off)

## 7/ Internal Connectors

### 7.1. Power Connector

Power connector must be used to supply the board with +12 VDC ( $\pm 5\%$ ).

#### **NOTICE**

Hot plugging any of the power connector is not allowed.

Hot plugging might damage the board. In other words, turn off main supply etc. to make sure all the power lines are turned off when connecting to the motherboard.

#### 7.1.1. Power Input Wafer (CN12)

The 1x4-pin 3.0 mm pitch power input wafer CN12 provides +12 V DC to the board.

Figure 11: Power Input Wafer CN12

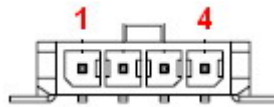

Table 18: Pin Assignment CN12

Pin	Signal	Description	Note
1	+12Vin	Power +12 V	
2	GND	Ground	
3	GND	Ground	
4	+12Vin	Power +12 V	
<b>Connector Type</b>			
B2W, 1x4-pin, 3.0 mm pitch			
<b>Mating Connector</b>			
Vendor	Pinrex		
Housing Model No.	733-75-M104B6		
Terminal Model No.	733-70-FT0006		

## 7.1.2. RTC Power Input Wafer (CN16)

The 1x2-pin 1.25 mm pitch RTC power input wafer CN16 is intended to be connected to the battery. The battery provides power to the system clock to retain the time when power is turn off.

Figure 12: RTC Power Input Wafer CN16



Table 19: Pin Assignment CN16

Pin	Signal	Description	Note
1	+VRTC	Real-time clock backup battery input	
2	GND	Ground	
<b>Connector Type</b>			
B2W, 1x2-pin, 1.25 mm pitch			
<b>Mating Connector</b>			
Vendor	Pinrex		
Housing Model No.	712-75-02W001		
Terminal Model No.	712-70-T00001		

## 7.2. Fan Wafer (CN3)

The 1x4-pin 2.54 mm pitch fan wafer CN3 is used for the connection of the fan for the processor or system.

Figure 13: Fan Wafer CN3

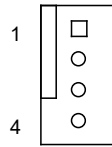

Table 20: Pin Assignment CN3

Pin	Signal	Description	Note
1	GND	Power supply ground signal	
2	+12V	+12 V power supply for fan	1 A max.
3	SENSE	Sense input signal from the fan, for rotation speed supervision RPM (Rotations Per Minute).	
4	PWM	PWM output signal for FAN speed control	
<b>Connector Type</b>			
B2W, 1x4-pin, 2.54 mm pitch			

### 7.3. SATA (Serial ATA) Connector (CN13)

The SATA connector CN13 supplies the data connection for the SATA hard disk and is SATA 3.0 compatible.

Figure 14: SATA Connector CN13

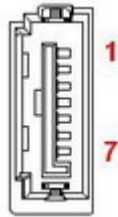

Table 21: Pin Assignment CN13

Pin	Signal	Description	Note
1	GND	Ground	
2	TX+	Host transmitter differential signal pair (+)	
3	TX-	Host transmitter differential signal pair (-)	
4	GND	Ground	
5	RX-	Host receiver differential signal pair (-)	
6	RX+	Host receiver differential signal pair (+)	
7	GND	Ground	
<b>Connector Type</b>			
B2W, 1x7-pin, 1.27 mm pitch			
<b>Mating Connector</b>			
Vendor	WINWIN		
Model No.	WATC-07DLPO2U		

## 7.4. SATA Power Output Wafer (CN10)

The 1x4-pin 2.0 mm pitch SATA power output wafer CN10 provides power to the SATA hard disk.

Figure 15: SATA Power Output Wafer CN10



Table 22: Pin Assignment CN10

Pin	Signal	Description	Note
1	+12V	+12 V power supply for HDD / SSD	1 A max.
2	GND	Ground	
3	GND	Ground	
4	+5V	+5 V power supply for HDD / SSD	1 A max.
<b>Connector Type</b>			
B2W, 1x4-pin, 2.0 mm pitch			
<b>Mating Connector</b>			
<b>Vendor</b>	Pinrex		
<b>Housing Model No.</b>	721-75-04W009		
<b>Terminal Model No.</b>	721-70-T00009		

## 7.5. USB Connectors (Internal) (CN20 & CN21)

The 10-pin 2.0 mm pitch USB port pin headers CN20 & CN21 support two USB 2.0 ports each.

Figure 16: USB 2.0 Port 4, 5 Pin Header CN20, Port 6, 7 Pin Header CN21

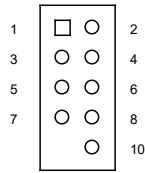

Table 23: Pin Assignment CN20, CN21

Pin	Signal	Description	Note
1	+USBVCC*	5 V supply. SB5V is supplied during power down to allow wakeup.	1 A max.
2	+USBVCC*	5 V supply. SB5V is supplied during power down to allow wakeup.	1 A max.
3	USB_DA-	USB 2.0 differential pair (-) for channel A	
4	USB_DB-	USB 2.0 differential pair (-) for channel B	
5	USB_DA+	USB 2.0 differential pair (+) for channel A	
6	USB_DB+	USB 2.0 differential pair (+) for channel B	
7	GND	Ground	
8	GND	Ground	
9	KEY		
10	GND	Ground	
<b>Connector Type</b>			
B2W, 2x5-pin, 2.0 mm pitch			
<b>Mating Connector</b>			
<b>Vendor</b>	Pinrex		
<b>Housing Model No.</b>	WL2004H-2*5P(DP2.0)		
<b>Terminal Model No.</b>	KB931-21T1A		



\* The power source of +USBVCC for CN20 and CN21 can be selected through JP8.



## 7.6. Audio AMP Output Wafer (CN1 & CN4)

The Speaker audio-out interface is available through the 2-pin 2.0 mm pitch wafers CN1 for left channel and CN4 for right channel. These outputs are shared with the audio output (Line-out) signals of the audio pin header CN5.

Figure 17: Audio AMP Output Wafer CN1 (Left Channel), CN4 (Right Channel)

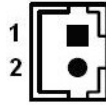

Table 24: Pin Assignment CN1, CN4

Pin	Signal	Description	Note
1	Speaker+	Speaker output (+)	
2	Speaker-	Speaker output (-)	
<b>Connector Type</b>			
B2W, 1x2-pin, 2.0 mm pitch			
<b>Mating Connector</b>			
Vendor	Pinrex		
Housing Model No.	721-75-02W009		
Terminal Model No.	721-70-T00009		

## 7.7. Audio Input / Output Header (CN5)

The 10-pin 1.25 mm pitch audio input / output header CN5 provides audio output (Line-Out), audio input (Line-In) and microphone (Mic-In) signals. The audio output signals are shared with those of the speaker connectors CN1 & CN4.

Figure 18: Audio Input / Output Header CN5

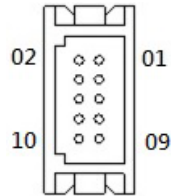

Table 25: Pin Assignment CN5

Pin	Signal	Description	Note
1	MIC-In_L	Microphone input left channel signal	
2	MIC-In_R	Microphone input right channel signal	
3	MIC-In_JD#	Microphone jack detection	
4	Line-In_JD#	Audio input jack detection	
5	Line-In_L	Audio input left channel signal	
6	Line-In_R	Audio input right channel signal	
7	Line-Out_L	Audio output left channel signal	
8	Line-Out_R	Audio output right channel signal	
9	Line-Out_JD#	Audio output jack detection	
10	GND	Ground	
<b>Connector Type</b>			
B2W, 2x5-pin, 1.25 mm pitch			
<b>Mating Connector</b>			
Vendor	HRS		
Housing Model No.	DF13-10DS-1.25C		
Terminal Model No.	WL1255-T-T-S		

## 7.8. Front Panel Header (FP1 & FP2)

The 8-pin 2.54 mm pitch front panel header FP1 supplies signals for the reset button, storage LED and system warning speaker.

The 10-pin 2.54 mm pitch front panel header FP2 supplies signals for the power button, power LED, and SM Bus.

Figure 19: Front Panel Header 1 FP1

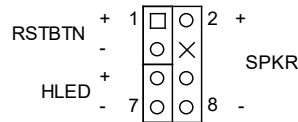

Table 26: Pin Assignment FP1

Pin	Signal	Description	Note
1	Reset Button +	System reset button (+)	
2	Speaker +	External system warning speaker (+)	
3	Reset Button -	System reset button (-)	
4	-	No connection	
5	HDD LED +	HDD activity LED (+). The LED lights up or flashes when data is ready from or written to the HDD.	
6	Internal Speaker -	Internal system warning speaker (-)	
7	HDD LED -	HDD activity LED (-).	
8	Speaker -	External system warning speaker (-)	
<b>Connector Type</b>			
B2W, 2x4-pin, 2.54 mm pitch			
<b>Mating Connector</b>			
Vendor	Pinrex		
Housing Model No.	741-75-204B01		
Terminal Model No.	741-70-FT0001		



Internal Buzzer is enabled when Pin6-8 is shorted.

Figure 20: Front Panel Header 2 FP2

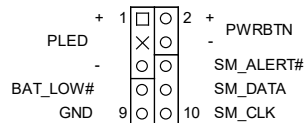

Table 27: Pin Assignment FP2

Pin	Signal	Description	Note
1	Power LED +	System Power LED (+). The LED lights up when users turn on the	

Pin	Signal	Description	Note
		system power, and blinks when the system is in sleep mode.	
2	Power Button +	System power button (+). Pressing the power button turns the system on or puts the system in sleep or soft-off mode depending on the operating system settings. Pressing the power switch for more than four seconds while the system turns from ON to OFF.	
3	-	No connection	
4	Power Button -	System power button (-).	
5	Power LED -	System Power LED (-).	
6	-	No connection	
7	-	No connection	
8	SMBus Data	System management bus bidirectional data line	
9	GND	Ground	
10	SMBus Clock	System management bus bidirectional clock line	
<b>Connector Type</b>			
B2W, 2x5-pin, 2.54 mm pitch			
<b>Mating Connector</b>			
<b>Vendor</b>	Pinrex		
<b>Housing Model No.</b>	741-75-205B01		
<b>Terminal Model No.</b>	741-70-FT0001		

## 7.9. Serial COM1 & COM2 Ports (CN30 & CN29)

The 10-pin 1.25 mm pitch serial COM wafers CN30 and CN29 provide RS232/422/485 connections.

Figure 21: Serial COM CN30, CN29

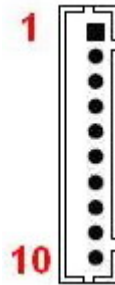

Table 28: Pin Assignment CN30, CN29

Pin	RS232 Signal	RS422 Signal	Half Duplex RS485 Signal	Full Duplex RS485 Signal	Note
1	DCD	TX-	DATA-	TX-	
2	DSR	-	-	-	
3	RXD	TX+	DATA+	TX+	
4	RTS	-	-	-	
5	TXD	RX+	-	RX+	
6	CTS	-	-	-	
7	DTR	RX-	-	RX-	
8	RI	-	-	-	
9	GND	GND	GND	GND	
10	+5V	+5V	+5V	+5V	500 mA max.
<b>Connector Type</b>					
B2W, 1x10-pin, 1.25 mm pitch					
<b>Mating Connector</b>					
<b>Vendor</b>	Pinrex				
<b>Housing Model No.</b>	712-75-10W001				
<b>Terminal Model No.</b>	712-70-T00001				

Table 29: Signal Description

Signal	Description
TXD	Transmitted Data, sends data to the communications link. The signal is set to the marking state (-12 V) on hardware reset when the transmitter is empty or when loop mode operation is initiated.
RXD	Received Data, receives data from the communications link.
DTR	Data Terminal Ready, indicates to the modem etc. that the on-board UART is ready to establish communication link.
DSR	Data Set Ready, indicates that the modem etc. is ready to establish a communications link.
RTS	Request To Send, indicates to the modem etc. that the on-board UART is ready to

Signal	Description
	exchange data.
CTS	Clear To Send, indicates that the modem or data set is ready to exchange data.
DCD	Data Carrier Detect, indicates that the modem or data set has detected the data carrier.
RI	Ring Indicator, indicates that the modem has received a ringing signal from the telephone line.
TX+/-	Transmitted Data differential pair sends data to the communications link.
RX+/-	Received Data differential pair receives data from the communications link.
GND	Power Supply GND signal

## 7.10. LVDS Connector (CN32)

The 30-pole 1.0 mm pitch connector CN32 provides 24-bit, 2-channel LVDS panel connection.

Figure 22: LVDS Connector CN32

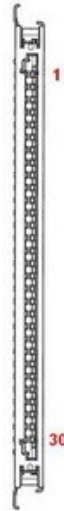

Table 30: Pin Assignment CN32

Pin	Signal	Description	Note
1	LVDSA_TX0-	LVDS Channel A Data 0 differential pair (-)	
2	LVDSA_TX0+	LVDS Channel A Data 0 differential pair (+)	
3	LVDSA_TX1-	LVDS Channel A Data 1 differential pair (-)	
4	LVDSA_TX1+	LVDS Channel A Data 1 differential pair (+)	
5	LVDSA_TX2-	LVDS Channel A Data 2 differential pair (-)	
6	LVDSA_TX2+	LVDS Channel A Data 2 differential pair (+)	
7	GND	Ground	
8	LVDSA_BCLK-	LVDS Channel A clock differential pair (-)	
9	LVDSA_BCLK+	LVDS Channel A clock differential pair (+)	
10	LVDSA_TX3-	LVDS Channel A Data 3 differential pair (-)	
11	LVDSA_TX3+	LVDS Channel A Data 3 differential pair (+)	
12	LVDSB_TX0-	LVDS Channel B Data 0 differential pair (-)	
13	LVDSB_TX0+	LVDS Channel B Data 0 differential pair (+)	
14	GND	Ground	
15	LVDSB_TX1-	LVDS Channel B Data 1 differential pair (-)	
16	LVDSB_TX1+	LVDS Channel B Data 1 differential pair (-)	
17	GND	Ground	
18	LVDSB_TX2-	LVDS Channel B Data 2 differential pair (-)	
19	LVDSB_TX2+	LVDS Channel B Data 2 differential pair (+)	
20	LVDSB_BCLK-	LVDS Channel B clock differential pair (-)	
21	LVDSB_BCLK+	LVDS Channel B clock differential pair (+)	

Pin	Signal	Description	Note
22	LVDSB_TX3-	LVDS Channel B Data 3 differential pair (-)	
23	LVDSB_TX3+	LVDS Channel B Data 3 differential pair (+)	
24	GND	Ground	
25	DDC_DATA	DDC channel Data	
26	VDDEN	Output Display Enable	
27	DDC_CLK	DDC Channel Clock	
28	+VPNL *	+3.3 V / +5 V panel power supply	500 mA max.
29	+VPNL *	+3.3 V / +5 V panel power supply	500 mA max.
30	+VPNL *	+3.3 V / +5 V panel power supply	500 mA max.
<b>Connector Type</b>			
B2W, 1x30-pin, 1.0 mm pitch			
<b>Mating Connector</b>			
Vendor	JAE		
Model No.	FI-X30HL		



---

\* Panel Power can be selected through JP4.

---



## 7.11. LVDS Backlight Power Wafer (CN31)

The 7-pin 1.25 mm pitch wafer CN31 provides power supply for flat panel and its backlight inverter.

Figure 23: LVDS Backlight Power Wafer CN31



Table 31: Pin Assignment CN31

Pin	Signal	Description	Note
1	BL_EN***	Backlight Enable signal	
2	GND	Ground	
3	+VBKLT**	+5 V / +12 V backlight power supply	750 mA max.
4	+VBKLT**	+5 V / +12 V backlight power supply	750 mA max.
5	GND	Ground	
6	BL_ADJ_VOL*	Backlight Adjustment Voltage signal	
7	BL_ADJ_PWM*	Backlight Adjustment PWM (Pulse Width Modulation) signal	
<b>Connector Type</b>			
B2W, 1x7-pin, 1.25 mm pitch			
<b>Mating Connector</b>			
Vendor	Pinrex		
Housing Model No.	712-75-07W001		
Terminal Model No.	712-70-T00001		



\* BL\_ADJ can be selected through JP5.



\*\* Backlight Power can be selected through JP1.



\*\*\* BL\_EN can be selected through JP3.

## 7.12. Digital Input / Output Header (CN27)

The 10-pin 1.25 mm pitch header CN27 supports 8-bit digital input / output signals to provide powering-on function of the connected devices.

Figure 24: Digital Input / Output Header CN27

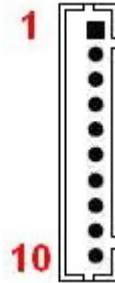

Table 32: Pin Assignment CN27

Pin	Signal	Description	Note
1	+5V	+5 V power supply	500 mA max.
2	DIO_0	Digital input / output channel 0	
3	DIO_1	Digital input / output channel 1	
4	DIO_2	Digital input / output channel 2	
5	DIO_3	Digital input / output channel 3	
6	DIO_4	Digital input / output channel 4	
7	DIO_5	Digital input / output channel 5	
8	DIO_6	Digital input / output channel 6	
9	DIO_7	Digital input / output channel 7	
10	GND	Ground	
<b>Connector Type</b>			
B2W, 1x10-pin, 1.25 mm pitch			
<b>Mating Connector</b>			
<b>Vendor</b>	Pinrex		
<b>Housing Model No.</b>	712-75-10W001		
<b>Terminal Model No.</b>	712-70-T00001		

### 7.13. CAN Bus Header (CN26 & CN28)

The 4-pin 1.25 mm pitch headers CN26 and CN28 support CAN Bus ports to connect sensors and controllers (Electronic Control Units - ECUs) within an automotive or industrial CAN communication network.

Figure 25: CAN Bus Header CN26, CN28

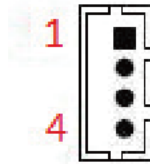

Table 33: Pin Assignment CN26, CN28

Pin	Signal	Description	Note
1	GND	Ground	
2	CAN_H	CAN high bus line	
3	CAN_L	CAN low bus line	
4	+5V	+5 V power supply	500 mA max.
<b>Connector Type</b>			
B2W, 1x4-pin, 1.25 mm pitch			
<b>Mating Connector</b>			
Vendor	Pinrex		
Housing Model No.	712-75-4W001		
Terminal Model No.	712-70-T00001		



---

The function of CAN Bus works only under Linux OS.

---

## 7.14. I<sup>2</sup>C Wafer (CN7)

The 4-pin 1.25 mm pitch wafer CN7 supports an I<sup>2</sup>C interface to connect sensors or other devices over I<sup>2</sup>C protocol.

Figure 26: I<sup>2</sup>C Wafer CN7

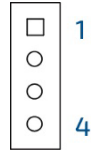

Table 34: Pin Assignment CN7

Pin	Signal	Description	Note
1	I2C2_SCL	I <sup>2</sup> C serial clock line	
2	I2C2_SDA	I <sup>2</sup> C serial data line	
3	+3.3V	+3.3 V power supply	500 mA max.
4	GND	Ground	
<b>Connector Type</b>			
B2W, 1x4-pin, 1.25 mm pitch			
<b>Mating Connector</b>			
<b>Vendor</b>			
<b>Housing Model No.</b>			
<b>Terminal Model No.</b>			

## 7.15. GSPI Wafer (CN2)

The 7-pin 1.25 mm pitch wafer CN2 supports devices that use serial protocol for transferring data.

Figure 27: GSPI Wafer CN2

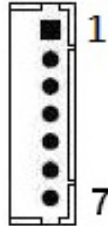

Table 35: Pin Assignment CN2

Pin	Signal	Description	Note
1	GSPI1_CLK	General SPI clock	
2	GSPI1_MOSI	General SPI master output / slave input	
3	GSPI1_MISO	General SPI master input / slave output	
4	GSPI1_CS0#	General SPI chip select bit 0	
5	GSPI1_CS1#	General SPI chip select bit 1	
6	+3.3V	+3.3 V power supply	500 mA max.
7	GND	Ground	
<b>Connector Type</b>			
B2W, 1x7-pin, 1.25 mm pitch			
<b>Mating Connector</b>			
Vendor			
Housing Model No.			
Terminal Model No.			

## 7.16. SPI 10-Pins Header (CN14)

The 10-pin 1.27 mm pitch header CN14 allows connection with a MCU (MicroController Unit) module for a particular application.

Figure 28: SPI 10-Pins Header CN14

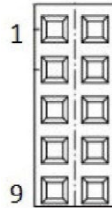

Table 36: Pin Assignment CN14

Pin	Signal	Description	Note
1	VDD	Primary supply input	
2	GND	Ground	
3	CS1#	SPI slave chip select bit 1	
4	CS0#	SPI slave chip select bit 0	
5	HOLD#	SPI HOLD	
6	SO	SPI slave serial data output	
7	SCK	SPI clock input	
8	WP#	Write-protect pin	
9	SI	SPI slave serial data input	
10	EN	Enable pin	
<b>Connector Type</b>			
B2B, 2x5-pin, 1.27 mm pitch			
<b>Mating Connector</b>			
<b>Vendor</b>			
<b>Housing Model No.</b>			
<b>Terminal Model No.</b>			

## 7.17. M.2 Key B 2242 / 2280 Slot (M2B1)

The 3.5"-SBC-EKL supports a M.2 module in format 2242 / 3042 / 2280 with Key B. The M.2 specification supports PCIe x1 and USB 2.0 signals as well as UIM signals connected to Micro SIM card holder CN6. The slot can be used to integrate WWAN communication or other possible function to the mainboard.

Figure 29: M.2 Key B 2242 / 3042 / 2280 Slot M2B1

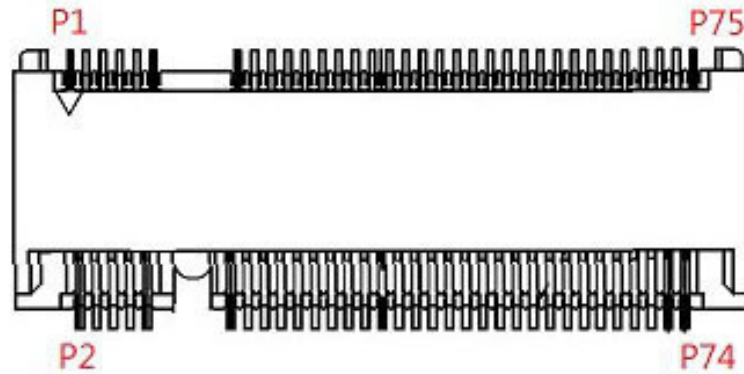

Table 37: Pin Assignment M2B1

Pin	Signal	Description	Note
1	-		
2	+3.3V	3.3 V power supply	
3	GND	Ground	
4	+3.3V	3.3 V power supply	
5	GND	Ground	
6	PWROFF#	M.2 module power enable	
7	USB_D+	USB 2.0 data differential pair (+)	
8	DISABLE#	Wireless disable	
9	USB_D-	USB 2.0 data differential pair (-)	
10	LED#	Device active signal	
11	GND	Ground	
12	KEY		
13	KEY		
14	KEY		
15	KEY		
16	KEY		
17	KEY		
18	KEY		
19	KEY		
20	-		
21	-		
22	-		
23	-		

Pin	Signal	Description	Note
24	-		
25	-		
26	-		
27	GND	Ground	
28	-		
29	-		
30	UIM_RESET*	SIM card reset	
31	-		
32	UIM_CLK*	SIM card clock	
33	GND	Ground	
34	UIM_DATA*	SIM card data	
35	-		
36	UIM_PWR*	SIM card power	
37	-		
38	-		
39	GND	Ground	
40	-		
41	PERn0	PCIe Lane 0 receiver pair (-)	
42	-		
43	PERp0	PCIe Lane 0 receiver pair (+)	
44	-		
45	GND	Ground	
46	-		
47	PETn0	PCIe Lane 0 transmitter pair (-)	
48	-		
49	PETp0	PCIe Lane 0 transmitter pair (+)	
50	PERST#	PCIe reset	
51	GND	Ground	
52	CLKREQ#	Reference clock request signal	
53	REFCLKn	PCIe reference clock pair (-)	
54	WAKE#	PCIe wake	
55	REFCLKp	PCIe reference clock pair (+)	
56	-		
57	GND	Ground	
58	-		
59	-		
60	-		
61	-		
62	-		
63	-		
64	-		
65	-		



Pin	Signal	Description	Note
66	SIM_DETECT	SIM card detect	
67	-		
68	SUSCLK	32.768 kHz clock supply input	
69	-		
70	+3.3V	3.3 V power supply	
71	GND	Ground	
72	+3.3V	3.3 V power supply	
73	GND	Ground	
74	+3.3V	3.3 V power supply	
75	-		



---

\* These pins are connected to CN6 Micro SIM card holder directly.

---

## 7.18. M.2 Key E 2230 Slot (M2E1)

The 3.5"-SBC-EKL supports a M.2 module in format 2230 with Key E. The M.2 specification supports PCIe x1, USB 2.0, SDIO, UART and I<sup>2</sup>C signals. The slot can be used to integrate WLAN and / or Bluetooth communication or other possible function to the mainboard.

Figure 30: M.2 Key E 2230 Slot M2E1

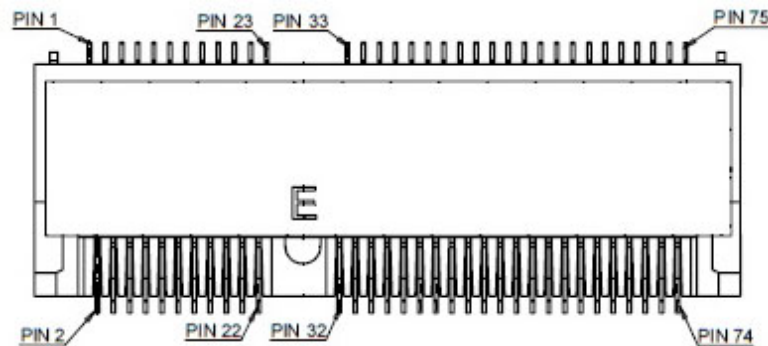

Table 38: Pin Assignment M2E1

Pin	Signal	Description	Note
1	GND	Ground	
2	+3.3V	3.3 V power supply	
3	USB_D+	USB 2.0 data diff. pair (+)	
4	+3.3V	3.3 V power supply	
5	USB_D-	USB 2.0 data diff. pair (-)	
6	LED1#	Device active signal 1	
7	GND	Ground	
8	I2S_SCK	I <sup>2</sup> S serial clock	
9	SDIO_CLK	SDIO clock	
10	I2S_WS	I <sup>2</sup> S word select	
11	SDIO_CMD	SDIO command line	
12	I2S_SD_IN	I <sup>2</sup> S serial data input	
13	SDIO_DATA0	SDIO data bit 0	
14	I2S_SD_OUT	I <sup>2</sup> S serial data output	
15	SDIO_DATA1	SDIO data bit 1	
16	LED2#	Device active signal 2	
17	SDIO_DATA2	SDIO data bit 2	
18	GND	Ground	
19	SDIO_DATA3	SDIO data bit 3	
20	UART_WAKE#	UART wake-up	
21	SDIO_CDN	SDIO card detect signal	
22	UART_RX	UART data input	
23	SDIO_WP	SDIO write protect signal	
24	Key		

Pin	Signal	Description	Note
25	Key		
26	Key		
27	Key		
28	Key		
29	Key		
30	Key		
31	Key		
32	UART_TXD	UART data output	
33	GND	Ground	
34	UART_CTS	UART clear to send	
35	PETp0	PCIe Lane 0 Tx pair (+)	
36	UART_RTS	UART request to send	
37	PETn0	PCIe Lane 0 Tx pair (-)	
38	-		
39	GND	Ground	
40	-		
41	PERp0	PCIe Lane 0 Rx pair (+)	
42			
43	PERn0	PCIe Lane 0 Rx pair (-)	
44	-		
45	GND	Ground	
46	-		
47	REFCLKp	PCIe reference clock pair (+)	
48	-		
49	REFCLKn	PCIe reference clock pair (-)	
50	SUSCLK	32.768 kHz clock supply input	
51	GND	Ground	
52	PERST0#	PCIe reset	
53	CLKREQ0#	Reference clock request signal	
54	W_DISABLE2#	Wireless disable 2	
55	PEWAKE0#	PCIe wake	
56	W_DISABLE1#	Wireless disable 1	
57	GND	Ground	
58	I2C_DATA	I <sup>2</sup> C data line	
59	-		
60	I2C_CLK	I <sup>2</sup> C clock line	
61	-		
62	ALERT#	Alert notification	
63	GND	Ground	
64	-		
65	-		
66	PERST1#	PCIe reset	

Pin	Signal	Description	Note
67	-		
68	CLKREQ1#	Reference clock request signal	
69	GND	Ground	
70	PEWAKE1#	PCIe wake	
71	-		
72	+3.3V	3.3 V power supply	
73	-		
74	+3.3V	3.3 V power supply	
75	GND	Ground	



Kontron offers 3 kinds of fixing bolt extensions and fastening screw to secure a M.2 Key B SSD / expansion card and / or a M.2 Key E expansion card. For configuration among card types, socket types, fixing bolts and fixing bolt extensions, view Table 38, Figure 31 and Table 39.

Table 39: Fixing Bolt Extensions and Fastening Screw









			
Item	A	B	C
Description	Fixing Bolt Extension	Fixing Bolt Extension	Fastening Screw
Dimensions	Nominal Size: M3 Length: 8.2 mm Head Height: 4.2 mm	Nominal Size: M3 Length: 7.2 mm Head Height: 3.2 mm	Nominal Size: M3 Length: 3.3 mm Head Height: 0.8 mm

Figure 31: Location of M.2 Key B & M.2 Key E Sockets and Fixing Bolts

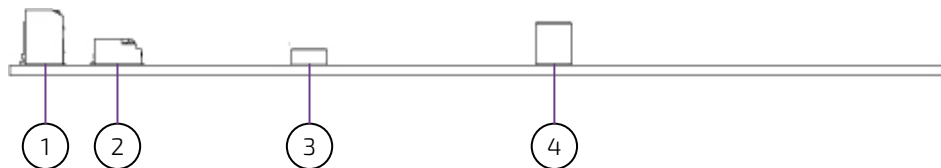

- 1 M.2 Key B Socket (see Figure 2, pos. 33)
- 2 M.2 Key E Socket (see Figure 2, pos. 34)
- 3 M.2 Fixing Bolt for Key B Type 22x42 / 30x42 and / or Key E Type 22x30 (see Figure 2)
- 4 M.2 Fixing Bolt for Key B Type 22x80 (see Figure 2)

Table 40: Installation Configuration of M.2 Key B SSD / Expansion Card and / or M.2 Key E Expansion Card

Key E Type 22x30	
Key B Type 22x42 / 30x42	
Key B Type 22x80	
Key B Type 22x42 / 30x42 + Key E Type 22x30	
Key B Type 22x80 + Key E Type 22x30	

## 7.19. M.2 Key M 2280 Slot (M2M1)

The 3.5"-SBC-EKL supports a M.2 module in format 2280 with Key M. The M.2 specification supports SATA 3.0 signal. The slot can be used to integrate an M.2 SATA SSD to the mainboard.

Figure 32: M.2 Key M 2280 Slot M2M1

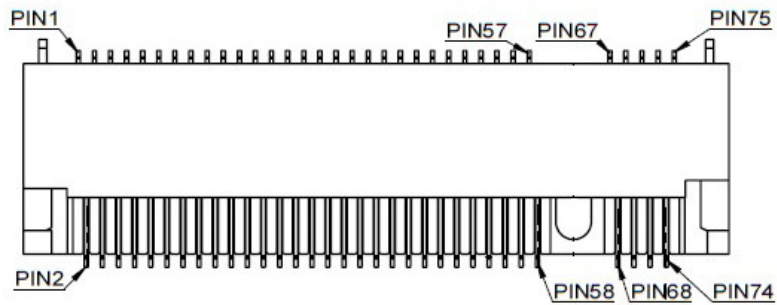

Table 41: Pin Assignment M2M1

Pin	Signal	Description	Note
1	GND	Ground	
2	+3.3V	3.3 V power supply	
3	GND	Ground	
4	+3.3V	3.3 V power supply	
5	-		
6	-		
7	-		
8	-		
9	GND	Ground	
10	DAS / DSS# / LED1#	Device active signal / disable staggered spin-up / LED	
11	-		
12	+3.3V	3.3 V power supply	
13	-		
14	+3.3V	3.3 V power supply	
15	GND	Ground	
16	+3.3V	3.3 V power supply	
17	-		
18	+3.3V	3.3 V power supply	
19	-		
20	-		
21	GND	Ground	
22	-		
23	-		
24	-		
25	-		
26	-		

Pin	Signal	Description	Note
27	GND	Ground	
28	-		
29	-		
30	-		
31	-		
32	-		
33	GND	Ground	
34	-		
35	-		
36	-		
37	-		
38	DEVSLP	Device sleep	
39	GND	Ground	
40	-		
41	SATA_B+	SATA receiver pair (+)	
42	-		
43	SATA_B-	SATA receiver pair (-)	
44	-		
45	GND	Ground	
46	-		
47	SATA_A-	SATA transmitter pair (-)	
48	-		
49	SATA_A+	SATA transmitter pair (+)	
50	-		
51	GND	Ground	
52	-		
53	-		
54	-		
55	-		
56	-		
57	GND	Ground	
58	-		
59	Key		
60	Key		
61	Key		
62	Key		
63	Key		
64	Key		
65	Key		
66	Key		
67	-		
68	SUSCLK	32.768 kHz clock supply input	

Pin	Signal	Description	Note
69	PEDET	PCIe detect	
70	+3.3V	3.3 V power supply	
71	GND	Ground	
72	+3.3V	3.3 V power supply	
73	GND	Ground	
74	+3.3V	3.3 V power supply	
75	GND	Ground	



## 7.20. Micro SIM Card Holder for M.2 Key B (CN6)

The Micro SIM card holder CN6 is intended to accommodate a Micro SIM card and connected to UIM signals on the M.2 Key B slot M2B1.

Figure 33: Micro SIM Card Holder CN6

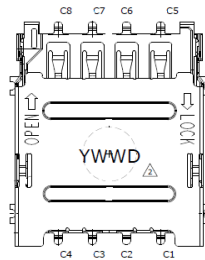

Table 42: Pin Assignment CN6

Pin	Signal	Description	Note
C1	VCC	Power +3.3 V	
C2	RST	Reset signal	
C3	CLK	Clock signal	
C4	NC	Not connected	
C5	GND	Ground	
C6	VPP	Programming voltage input	
C7	IO	Input or Output for serial data	
C8	NC	Not connected	

## 7.21. M.2 Key B / M.2 Key E / M.2 Key M Activity Indicator Header (CN11, CN9 & CN17)

The header CN11 is intended to connect M.2 Key B activity LED cable.

The header CN9 is intended to connect M.2 Key E activity LED cable.

The header CN17 is intended to connect M.2 Key M activity LED cable.

Figure 34: M.2 Key B / M.2 Key M Activity Indicator Header CN11, CN17

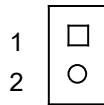

Table 43: Pin Assignment CN11, CN17

Pin	Signal	Description	Note
1	LED+	M.2 Key B / M.2 Key M activity LED (+)	
2	LED-	M.2 Key B / M.2 Key M activity LED (-)	
<b>Connector Type</b>			
B2W, 1x2-pin, 2.0 mm pitch			

Figure 35: M.2 Key E Activity Indicator Header CN9

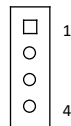

Table 44: Pin Assignment CN9

Pin	Signal	Description	Note
1	WLAN_LED1+	WLAN LED (+)	
2	WLAN_LED1-	WLAN LED (-)	
3	BR_LED2+	Breath LED (+)	
4	BR_LED2-	Breath LED (-)	
<b>Connector Type</b>			
B2W, 1x4-pin, 2.0 mm pitch			

## 7.22. B2B Connector (CN15)

The board-to-board connector CN15 provides connection to a daughter board for additional I/O port and / or feature expansion. The specification of the B2B connector supports PCIe x2, SM bus, I<sup>2</sup>C, UART and GSPI signals.

Figure 36: B2B Connector CN15

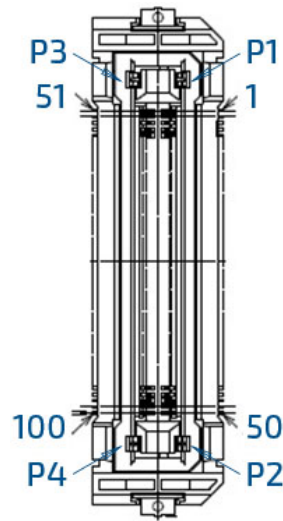

Table 45: Pin Assignment CN15

Pin	Signal	Description	Note
1	+3.3VSB_OUT	3.3 V standby power output	400 mA max.
2	+3.3VSB_OUT	3.3 V standby power output	400 mA max.
3	+3.3VSB_OUT	3.3 V standby power output	400 mA max.
4	+3.3VSB_OUT	3.3 V standby power output	400 mA max.
5	+3.3VSB_OUT	3.3 V standby power output	400 mA max.
6	GND	Ground	
7	DDI2_TXP0	eDP / DP 2 Lane 0 transmitter pair (+)	
8	DDI2_TXN0	eDP / DP 2 Lane 0 transmitter pair (-)	
9	GND	Ground	
10	DDI2_TXP1	eDP / DP 2 Lane 1 transmitter pair (+)	
11	DDI2_TXN1	eDP / DP 2 Lane 1 transmitter pair (-)	
12	GND	Ground	
13	DDI2_TXP2	eDP / DP 2 Lane 2 transmitter pair (+)	
14	DDI2_TXN2	eDP / DP 2 Lane 2 transmitter pair (-)	
15	GND	Ground	
16	DDI2_TXP3	eDP / DP 2 Lane 3 transmitter pair (+)	
17	DDI2_TXN3	eDP / DP 2 Lane 3 transmitter pair (-)	
18	GND	Ground	
19	DP2_AUX+	eDP / DP 2 Auxiliary channel pair (+)	
20	DP2_AUX-	eDP / DP 2 Auxiliary channel pair (-)	

Pin	Signal	Description	Note
21	GND	Ground	
22	PCIE1_CLK_REF+	PCIe Lane 1 clock reference pair (+)	
23	PCIE1_CLK_REF-	PCIe Lane 1 clock reference pair (-)	
24	GND	Ground	
25	PCIE4_TX+	PCIe Lane 4 transmitter pair (+)	
26	PCIE4_TX-	PCIe Lane 4 transmitter pair (-)	
27	GND	Ground	
28	PCIE4_RX+	PCIe Lane 4 receiver pair (+)	
29	PCIE4_RX-	PCIe Lane 4 receiver pair (-)	
30	GND	Ground	
31	PCIE6_TX+	PCIe Lane 6 receiver pair (+)	
32	PCIE6_TX-	PCIe Lane 6 receiver pair (-)	
33	GND	Ground	
34	PCIE6_RX+	PCIe Lane 6 receiver pair (+)	
35	PCIE6_RX-	PCIe Lane 6 receiver pair (-)	
36	GND	Ground	
37	NC	Not connected	
38	NC	Not connected	
39	GND	Ground	
40	UART_TXD	UART transmitted data	
41	UART_RXD	UART received data	
42	UART_CTS#	UART clear to send	
43	UART_RTS#	UART request to send	
44	GND	Ground	
45	eDP_PWM	eDP backlight PWM (Pulse Width Modulation) signal	
46	eDP_VDDEN	eDP panel power enable signal	
47	eDP_BKLTEN	eDP backlight enable signal	
48	DP2_HPD	eDP / DP 2 hot plug detect	
49	DP2_EN#	eDP / DP 2 enable	
50	NC	Not connected	
51	GSPI_CLK	General SPI clock	
52	GSPI_MOSI	General SPI master output / slave input	
53	GSPI_MISO	General SPI master input / slave output	
54	GSPI_CS0#	General SPI chip select bit 0	
55	GSPI_CS1#	General SPI chip select bit 1	
56	GND	Ground	
57	NC	Not connected	
58	NC	Not connected	
59	GND	Ground	
60	NC	Not connected	
61	NC	Not connected	
62	GND	Ground	

Pin	Signal	Description	Note
63	NC	Not connected	
64	NC	Not connected	
65	GND	Ground	
66	NC	Not connected	
67	NC	Not connected	
68	GND	Ground	
69	NC	Not connected	
70	NC	Not connected	
71	GND	Ground	
72	PCIE2_CLK_REF+	PCIe Lane 2 clock reference pair (+)	
73	PCIE2_CLK_REF-	PCIe Lane 2 clock reference pair (-)	
74	GND	Ground	
75	PCIE5_TX+	PCIe Lane 5 transmitter pair (+)	
76	PCIE5_TX-	PCIe Lane 5 transmitter pair (-)	
77	GND	Ground	
78	PCIE5_RX+	PCIe Lane 5 receiver pair (+)	
79	PCIE5_RX-	PCIe Lane 5 receiver pair (-)	
80	GND	Ground	
81	PCIE7_TX+	PCIe Lane 7 transmitter pair (+)	
82	PCIE7_TX-	PCIe Lane 7 transmitter pair (-)	
83	GND	Ground	
84	PCIE7_RX+	PCIe Lane 7 receiver pair (+)	
85	PCIE7_RX-	PCIe Lane 7 receiver pair (-)	
86	GND	Ground	
87	NC	Not connected	
88	NC	Not connected	
89	GND	Ground	
90	I2C_CLK	I2C clock	
91	I2C_DATA	I2C data	
92	SMB_CLK	SM bus clock	
93	SMB_DATA	SM bus data	
94	GND	Ground	
95	SMB_ALERT#	SM bus alert	
96	PCIE_WAKE#	PCIe wake	
97	PCIE_PLTRST#	PCIe platform reset	
98	NC	Not connected	
99	NC	Not connected	
100	PS_ON#	Power supply enable / disable	
P1	+5VSB_OUT	5 V standby power output	2 A max.
P2	+12V_IN / +12V_OUT	12 V power input / 12 V power output	3 A max.
P3	+12V_IN / +12V_OUT	12 V power input / 12 V power output	3 A max.
P4	+12V_IN / +12V_OUT	12 V power input / 12 V power output	3 A max.

Pin	Signal	Description	Note
<b>Connector Type</b>			
B2B, 2x50-pin, 0.5 mm pitch			
<b>Mating Connector</b>			
Vendor	HRS		
Model No.	FX23-100P-0.5SV20		

## 7.23. Switches and Jumpers

The product has several jumpers which must be properly configured to ensure correct operation.

Figure 37: Jumper Connector

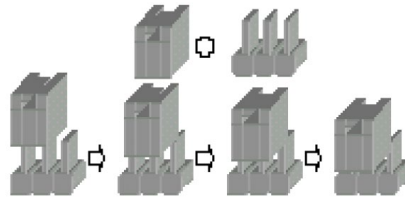

For a three-pin jumper (see Figure 36), the jumper setting is designated "1-2" when the jumper connects pins 1 and 2. The jumper setting is designated "2-3" when pins 2 and 3 are connected and so on. You will see that one of the lines surrounding a jumper pin is thick, which indicates pin No.1.

To move a jumper from one position to another, use needle-nose pliers or tweezers to pull the pin cap off the pins and move it to the desired position.

### 7.23.1. LVDS Backlight Enable Voltage Selection (JP1)

The 2.0 mm patch "LVDS Backlight Enable Voltage Selection" jumper JP1 can be used to select voltage level of backlight enable signal.

Figure 38: LVDS Backlight Enable Voltage Selection JP1

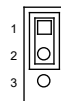

Table 46: Pin Assignment JP1

Jumper 1 Position		Description
Pin 1-2	Pin 2-3	
X	-	+3.3 V
-	X	+5 V

"X" = Jumper set (short) and "-" = jumper not set (open)

### 7.23.2. AT / ATX Power Mode Selection (JP2)

The 2.0 mm pitch jumper JP2 can be used to select AT power mode or ATX power mode.

Figure 39: AT / ATX Power Mode Selection JP2

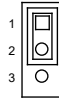

Table 47: Pin Assignment JP2

Jumper 1 Position		Description
Pin 1-2	Pin 2-3	
X	-	ATX Power Mode
-	X	AT Power Mode

"X" = Jumper set (short) and "-" = jumper not set (open)

### 7.23.3. LVDS Backlight Enable Selection (JP3)

The 2.0 mm pitch "LVDS Backlight Enable Selection" jumper JP3 can be used to select the polarity of backlight enable signal.

Figure 40: LVDS Backlight Enable Selection JP3

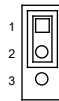

Table 48: Pin Assignment JP3

Jumper 1 Position		Description
Pin 1-2	Pin 2-3	
X	-	High Active
-	X	Low Active

"X" = Jumper set (short) and "-" = jumper not set (open)



### 7.23.4. LVDS Panel Power Selection (JP4)

The 2.54 mm pitch "LVDS Panel Power Selection" jumper JP4 can be used to select LVDS panel and backlight power voltage.

Figure 41: LVDS Panel Power Selection JP4

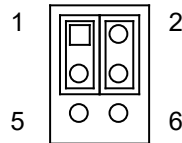

Table 49: Pin Assignment JP4

Jumper 1 Position		Description
Pin 1-3	Pin 3-5	
X	-	Backlight Power = +12 V
-	X	Backlight Power = +5 V
Jumper 2 Position		Description
Pin 2-4	Pin 4-6	
X	-	Panel Power = +3.3 V
-	X	Panel Power = +5 V

"X" = Jumper set (short) and "-" = jumper not set (open)

### 7.23.5. LVDS Backlight Control Selection (JP5)

The 2.0 mm pitch "LVDS Backlight Control Selection" jumper JP5 can be used to select by which mode the brightness level in the LCD panel is controlled.

Figure 42: LVDS Backlight Control Selection JP5



Table 50: Pin Assignment JP5

Jumper 1 Position		Description
Pin 1-2	Pin 2-3	
X	-	PWM Control Mode
-	X	Voltage Control Mode

"X" = Jumper set (short) and "-" = jumper not set (open)

### 7.23.6. Flash Descriptor Security Override Selection (JP6)

The 2.0 mm pitch "Flash Descriptor Security Override Selection" jumper JP6 can be used to specify whether to override the flash descriptor.

Figure 43: Flash Descriptor Security Override Selection JP6

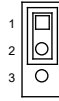

Table 51: Pin Assignment JP6

Jumper 1 Position		Description
Pin 1-2	Pin 2-3	
X	-	Normal Operation
-	X	Flash Security Override

"X" = Jumper set (short) and "-" = jumper not set (open)

### 7.23.7. Clear CMOS Selection (JP7)

The 2.0 mm pitch "Clear CMOS Selection" jumper JP7 can be used to reset the Real Time Clock (RTC) and drain RTC well.

The jumper has one position: Pin 1-2 mounted (default position) and Pin 2-3 mounted. More information on setting the "Clear CMOS Selection" jumper can be found in the following table.

Figure 44: Clear CMOS Selection JP7

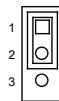

Table 52: Pin Assignment JP7

Jumper 1 Position		Description
Pin 1-2	Pin 2-3	
X	-	Normal Operation (default position)
-	X	Clear CMOS (board does not boot with the jumper in this position)

"X" = Jumper set (short) and "-" = jumper not set (open)



Do not leave the jumper in position 2-3, otherwise if the power is disconnected, the battery will fully deplete within a few weeks.

### 7.23.8. USB Power Selection (JP8)

The 2.0 mm pitch "USB Power Selection" jumper JP8 can be used to determine whether the USB ports are powered in the S4 / S5 state.

Figure 45: USB Power Selection JP8

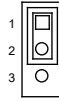

Table 53: Pin Assignment JP8

Jumper 1 Position		Description
Pin 1-2	Pin 2-3	
X	-	+5 V
-	X	+5 VSB

"X" = Jumper set (short) and "-" = jumper not set (open)

### 7.23.9. MFG Mode Selection (JP9)

The 2.0 mm pitch "MFG Mode Selection" jumper JP9 can be used to rewrite Intel ME firmware onto another version.

Figure 46: MFG Mode Selection JP9

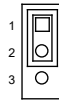

Table 54: Pin Assignment JP9

Jumper 1 Position		Description
Pin 1-2	Pin 2-3	
X	-	Normal Operation
-	X	Enable MFG Mode

"X" = Jumper set (short) and "-" = jumper not set (open)

## 8/ BIOS

### 8.1. Starting the uEFI BIOS

The 3.5"-SBC-EKL is provided with a Kontron-customized, pre-installed and configured version of AMI Aptio® V uEFI BIOS. AMI BIOS firmware is based on the Unified Extensible Firmware Interface (UEFI) specification and the Intel® Platform Innovation Framework for EFI. This uEFI BIOS provides a variety of new and enhanced functions specifically tailored to the hardware features of the 3.5"-SBC-EKL.

The uEFI BIOS comes with a setup program that provides quick and easy access to the individual function settings for control or modification of the uEFI BIOS configuration. The setup program allows the accessing of various menus that provide functions or access to sub-menus with more specific functions of their own.

To start the uEFI BIOS setup program, follow the steps below:

1. Power on the board.
2. Wait until the first characters appear on the screen (POST messages or splash screen).
3. Press the <DEL> key.
4. If the uEFI BIOS is password-protected, a request for password will appear. Enter either the User Password or the Supervisor Password (see Security menu), press <RETURN>, and proceed with step 5.
5. A setup menu will appear.

The 3.5"-SBC-EKL uEFI BIOS setup program uses a hot key-based navigation system. A hot key legend bar is located on the bottom of the setup screens.

The following table provides information concerning the usage of these hot keys.

**Table 55: Hotkeys Table**

Signal	Description
<F1>	The <F1> key invokes the General Help window.
<->	The <Minus> key selects the next lower value within a field.
<+>	The <Plus> key selects the next higher value within a field.
<F2>	The <F2> key loads the previous values.
<F3>	The <F3> key loads the standard default values.
<F4>	The <F4> key saves the current settings and exit the uEFI BIOS setup.
<→> or <←>	The <Left/Right> arrows select major setup menus on the menu bar. For example: Main, Advanced, Security, etc.
<↑> or <↓>	The <Up/Down> arrows select fields in the current menu. For example: A setup function or a sub-screen.
<ESC>	The <ESC> key exits a major setup menu and enter the Exit setup menu. Pressing the <ESC> key in a sub-menu displays the next higher menu level.
<RERURN>	The <RETURN> key executes a command or select a submenu.

## 8.2. Starting the uEFI BIOS

The Setup utility features shows six menus in the selection bar at the top of the screen:

- ▶ Main
- ▶ Advanced
- ▶ Power
- ▶ Boot
- ▶ Security
- ▶ Save & Exit

The Setup menus are selected via the left and right arrow keys. The currently active menu and the currently active uEFI BIOS Setup item are highlighted in white. Each Setup menu provides two main frames. The left frame displays all available functions. Functions that can be configured are displayed in blue. Functions displayed in gray provide information about the status or the operational configuration. The right frame displays an Item Specific Help window providing an explanation of the respective function.

### 8.2.1. Main Setup Menu

Upon entering the uEFI BIOS Setup program, the Main Setup menu is displayed. This screen lists the Main Setup menu sub-screens and provides basic system information. Additionally functions for setting the system time and date are offered.

**Table 56: Main Setup Menu Sub-Screens and Functions**

Function	Description
Product Information	Read only field. Displays information about the product, system BIOS and Intel Management Engine (ME) firmware
CPU Information	Read only field Display information about the processor
Memory Information	Read only field. Displays information about total memory
System Date	Set System Date
System Time	Set System Time

Figure 47: BIOS Main Menu Screen System Data and Time

Aptio Setup – AMI					
Main	Advanced	Power	Boot	Security	Save & Exit
Product Information					
Product Name	3.5-SBC-EKL				
BIOS Version	0.0H (x64)				
BIOS Build Date	03/08/2023				
ME Firmware SKU	Consumer SKU				
ME Firmware Version	15.40.27.2735				
CPU Information					
Intel® Atom® x6212RE Processor @ 1.20 GHz					
Microcode Revision	17				
Processor Cores	2 Core(s) / 2 Thread(s)				
Memory Information				→ ←: Select Screen	
Total Size	4096 MB (DDR4)				
Frequency	2667 MTPS				
System Date				↑ ↓: Select Item	
System Time				Enter: Select	
Access Level				+/-: Change Opt.	
				F1: General Help	
				F2: Previous Values	
				F3: Optimized Defaults	
				F4: Save & Exit	
				ESC: Exit	
Version 2.22.1282 Copyright (C) 2023 AMI					

Feature	Option	Description
System Date	[dd/mm/yyyy]	Set the Date. Use Tab to switch between Data elements.
System Time	[hh:mm:ss]	Set the Time. Use Tab to switch between Time elements.

## 8.2.2. Advanced Setup Menu

The Advanced setup menu provides sub-screens and functions for advanced configurations. The following sub-screen functions are included in the menu:

- ▶ Audio & LAN Configuration
- ▶ Display Configuration
- ▶ Super IO Configuration
- ▶ CPU Chipset Configuration
- ▶ NVMe Configuration
- ▶ SATA Configuration
- ▶ USB Configuration
- ▶ Trusted Computing
- ▶ PSE Configuration
- ▶ Network Stack
- ▶ H/W Monitor
- ▶ DIO Configuration

---

**NOTICE**

Setting items on this screen to incorrect values may cause the system to malfunction.

---

Figure 48: BIOS Advanced Menu

Aptio Setup – AMI					
Main	Advanced	Power	Boot	Security	Save & Exit
Onboard LAN1 Controller		[Enabled]			
Onboard LAN2 Controller		[Enabled]			
Load Intel I226 UNDI Driver*		[Disabled]			
Load Intel I226 UNDI Driver**		[Disabled]			
Audio Controller		[Enabled]			
> Display Configuration					
> Super IO Configuration					
> CPU Chipset Configuration					
> NVMe Configuration					
> SATA Configuration					
> USB Configuration					
> Trusted Computing					
> PSE Configuration					
> Network Stack					
> H/W Monitor					
> DIO Configuration					
				→ ←: Select Screen	
				↑ ↓: Select Item	
				Enter: Select	
				+/-: Change Opt.	
				F1: General Help	
				F2: Previous Values	
				F3: Optimized Defaults	
				F4: Save & Exit	
				ESC: Exit	
Version 2.22.1282 Copyright (C) 2023 AMI					

\* This item appears only when enabling Onboard LAN1 Controller.

\*\* This item appears only when enabling Onboard LAN2 Controller.

Feature	Option	Description
Onboard LAN1 Controller	[Disabled], [Enabled]	Select whether to enable or disable Onboard LAN1 Controller.
Onboard LAN2 Controller	[Disabled], [Enabled]	Select whether to enable or disable Onboard LAN2 Controller.
Load Intel I226 UNDI Driver	[Disabled], [Enabled]	Select whether to load onboard UNDI Driver.
Audio Controller	[Disabled], [Enabled]	Select whether to enable or disable Audio Controller.



Figure 49: BIOS Advanced Menu - Display Configuration

Aptio Setup – AMI					
Main	Advanced	Power	Boot	Security	Save & Exit
Display Configuration					
Aperture Size		[256MB]			
DVMT Pre-Allocated		[32M]			
DVMT Total Gfx Mem		[256MB]			
Primary IGFX Boot Display				→ ←: Select Screen	
Active LVDS		[VBIOS Default]		↑ ↓: Select Item	
LVDS Panel Type*		[Disabled]		Enter: Select	
LVDS Panel Color Depth*		[1366x768 1CH]		+/-: Change Opt.	
LVDS Panel Color Depth*		[18Bit]		F1: General Help	
PWM Backlight Control*		[By External]		F2: Previous Values	
LVDS Backlight Control Mode <sup>(1)</sup>		[Voltage]		F3: Optimized Defaults	
LVDS Backlight Control - PWM <sup>(1)(2)</sup>		127		F4: Save & Exit	
LVDS Backlight Control - Voltage <sup>(1)(3)</sup>		[2.5 V]		ESC: Exit	
Version 2.22.1282 Copyright (C) 2023 AMI					

\* These items appear only when enabling Active LVDS.

<sup>(1)</sup> These items appear only when selecting By External for PWM Backlight Control.

<sup>(2)</sup> This item appears only when selecting PWM for the LVDS Backlight Control Mode.

<sup>(3)</sup> This item appears only when selecting Voltage for the LVDS Backlight Control Mode.

Feature	Option	Description
Aperture Size	[128MB], [256MB], [512MB], [1024MB]	Select the Aperture Size. Note: Above 4GB MMIO BIOS assignment is automatically enabled when selecting 2048MB aperture. To use this feature, please disable CSM Support.
DVMT Pre-Allocated	[32M], [64M], [96M], [128M], [160M]	Select DVMT 5.0 Pre-Allocated (Fixed) Graphics Memory size used by the Internal Graphics Device.
DVMT Total Gfx Mem	[128M], [256M], [MAX]	Select DVMT 5.0 Total Graphic Memory size used by the Internal Graphics Device.
Primary IGFX Boot Display	[VBIOS Default]	Read only item.
Active LVDS	[Disabled], [Enabled]	Select the Active LVDS Configuration. [Disabled]: don't enable LVDS. [Enabled]: enable LVDS.
LVDS Panel Type	[800x600 1CH], [1024x768 1CH], [1280x1024 2CH],	LVDS panel by selecting the appropriate setup item.

Feature	Option	Description
	[1366x768 1CH], [1366x768 2CH], [1600x1200 2CH], [1920x1080 2CH]	
LVDS Panel Color Depth	[18Bit], [24Bit]	LVDS panel color depth by appropriate setup item.
PWM Backlight Control	[By External], [By Internal]	[By External]: Control by external HW circuit. [By Internal]: Control by LBKL_CTL on the Intel Chipset.
LVDS Backlight Control Mode	[Voltage], [PWM]	LVDS Backlight Power Wafer output control
LVDS Backlight Control - PWM	Value input	0 – 255 PWM Duty
LVDS Backlight Control - Voltage	[0.0 V], [0.5 V], [1.0 V], [1.5 V], [2.0 V], [2.5 V], [3.0 V], [3.5 V], [4.0 V], [4.5 V], [5.0 V]	Min: 0.0 V Max: 5.0 V

Figure 50: BIOS Advanced Menu - Super IO Configuration

Aptio Setup – AMI					
Main	Advanced	Power	Boot	Security	Save & Exit
Super IO Configuration					
> Serial Port 1 Configuration > Serial Port 2 Configuration				→ ←: Select Screen ↑ ↓: Select Item Enter: Select +/-: Change Opt. F1: General Help F2: Previous Values F3: Optimized Defaults F4: Save & Exit ESC: Exit	
Version 2.22.1282 Copyright (C) 2023 AMI					

Figure 51: BIOS Advanced Menu - Super IO Configuration - Serial Port 1 Configuration

Aptio Setup – AMI					
Main	Advanced	Power	Boot	Security	Save & Exit
Super Port 1 Configuration					
Serial Port		[Enabled]		→ ←: Select Screen ↑ ↓: Select Item Enter: Select +/-: Change Opt. F1: General Help F2: Previous Values F3: Optimized Defaults F4: Save & Exit ESC: Exit	
Device Settings*		IO=3E8h; IRQ=3;			
Change Setting*		[IO=3E8h; IRQ=3, 4, 5, 6, ..., 12;]			
Serial Port 1 Type*		[RS232]			
RS485 Deplx Mode*(1)		[Half Duplex]			
RS485 Auto Flow Control*(1)(3)		[Disabled]			
RS485/422 Receiver Termination*(2)		[Enabled]			
Version 2.22.1282 Copyright (C) 2023 AMI					

\* These items appear only when enabling Serial Port.

(1) These items appear only when selecting RS485 for the Serial Port 1 Type.

(2) This item appears only when selecting RS485 or RS422 for the Serial Port 1 Type.

(3) This item appear only when selecting Half Duplex for RS485 Duplex Mode.

Feature	Option	Description
Serial Port	[Disabled], [Enabled]	Enable or Disable Serial Port (COM).
Change Settings	[Auto], [IO=3F8h; IRQ=4;], [IO=3F8h; IRQ=3, 4, 5, 6, 7, 9, 10, 11, 12;],	Select an optimal setting for Super IO device.

Feature	Option	Description
	[IO=2F8h; IRQ=3, 4, 5, 6, 7, 9, 10, 11, 12;], [IO=3E8h; IRQ=3, 4, 5, 6, 7, 9, 10, 11, 12;], [IO=2E8h; IRQ=3, 4, 5, 6, 7, 9, 10, 11, 12;]	
Serial Port 1 Type	[RS232], [RS422], [RS485]	Select an appropriate type for Serial Port 1.
RS485 Duplex Mode	[Half Duplex], [Full Duplex]	Select an appropriate RS485 Duplex Mode.
RS485 Auto Flow Control	[Disabled], [Enabled]	Select whether to enable or disable RS485 Auto Flow Control.
RS485/422 Receiver Termination	[Disabled], [Enabled]	Select whether to enable or disable RS485/422 Receiver Termination.

Figure 52: BIOS Advanced Menu - Super IO Configuration - Serial Port 2 Configuration

Aptio Setup – AMI					
Main	Advanced	Power	Boot	Security	Save & Exit
Super Port 2 Configuration					
Serial Port		[Enabled]		→ ←: Select Screen	
Device Settings*		IO=2F8h; IRQ=4;		↑ ↓: Select Item	
Change Setting*		[IO=2F8h; IRQ=3, 4, 5, 6, ..., 12;]		Enter: Select	
Serial Port 2 Type*		[RS232]		+/-: Change Opt.	
RS485 Duplex Mode*(1)		[Half Duplex]		F1: General Help	
RS485 Auto Flow Control*(1)(3)		[Disabled]		F2: Previous Values	
RS485/422 Receiver Termination*(2)		[Enabled]		F3: Optimized Defaults	
				F4: Save & Exit	
				ESC: Exit	
Version 2.22.1282 Copyright (C) 2023 AMI					

\* These items appear only when enabling Serial Port.

(1) These items appear only when selecting RS485 for the Serial Port 2 Type.

(2) This item appears only when selecting RS485 or RS422 for the Serial Port 2 Type.

(3) This item appear only when selecting Half Duplex for RS485 Duplex Mode.

Feature	Option	Description
Serial Port	[Disabled], [Enabled]	Enable or Disable Serial Port (COM).
Change Settings	[Auto], [IO=2F8h; IRQ=3;], [IO=3F8h; IRQ=3, 4, 5, 6, 7, 9, 10, 11, 12;], [IO=2F8h; IRQ=3, 4, 5, 6, 7, 9, 10, 11, 12;], [IO=3E8h; IRQ=3, 4, 5, 6, 7, 9, 10, 11, 12;], [IO=2E8h; IRQ=3, 4, 5, 6, 7, 9, 10, 11, 12;]	Select an optimal setting for Super IO device.
Serial Port 2 Type	[RS232],	Select an appropriate type for Serial Port 2.

Feature	Option	Description
	[RS422], [RS485]	
RS485 Duplex Mode	[Half Duplex], [Full Duplex]	Select an appropriate RS485 Duplex Mode.
RS485 Auto Flow Control	[Disabled], [Enabled]	Select whether to enable or disable RS485 Auto Flow Control.
RS485/422 Receiver Termination	[Disabled], [Enabled]	Select whether to enable or disable RS485/422 Receiver Termination.

Figure 53: BIOS Advanced Menu - CPU Chipset Configuration

Aptio Setup – AMI					
Main	Advanced	Power	Boot	Security	Save & Exit
CPU Chipset Configuration					
EIST		[Enabled]		→ ←: Select Screen	
VT-d		[Enabled]		↑ ↓: Select Item	
Active Processor Cores		[All]		Enter: Select	
Intel (VMX) Virtualization Technology		[Enabled]		+/-: Change Opt.	
				F1: General Help	
				F2: Previous Values	
				F3: Optimized Defaults	
				F4: Save & Exit	
				ESC: Exit	
Version 2.22.1282 Copyright (C) 2023 AMI					

Feature	Option	Description
EIST	[Disabled], [Enabled]	Select whether to enable or disable Enhanced Intel SpeedStep Technology
VT-d	[Disabled], [Enabled]	Select whether to enable or disable VT-d capability.
Active Processor Cores	[All], [1]	Number of cores to enable in each processor package.
Intel (VMX) Virtualization Technology	[Disabled], [Enabled]	When enabled, a VMM can utilize the additional hardware capabilities provided by Vanderpool Technology.

Figure 54: BIOS Advanced Menu - NVMe Configuration

Aptio Setup – AMI					
Main	Advanced	Power	Boot	Security	Save & Exit
NVMe Configuration					
No NVMe Device Found				→ ←: Select Screen ↑ ↓: Select Item Enter: Select +/-: Change Opt. F1: General Help F2: Previous Values F3: Optimized Defaults F4: Save & Exit ESC: Exit	
Version 2.22.1282 Copyright (C) 2023 AMI					

Figure 55: BIOS Advanced Menu - SATA Configuration

Aptio Setup – AMI					
Main	Advanced	Power	Boot	Security	Save & Exit
SATA Configuration					
SATA Controller(s)		[Enabled]		→ ←: Select Screen ↑ ↓: Select Item Enter: Select +/-: Change Opt. F1: General Help F2: Previous Values F3: Optimized Defaults F4: Save & Exit ESC: Exit	
SATA Mode Selection*		[AHCI]			
Serial ATA Port 1		Empty			
Port 1		[Enabled]			
M.2 Port 1		Empty			
Port 1		[Enabled]			
Version 2.22.1282 Copyright (C) 2023 AMI					

\* This item appears only when enabling SATA Controller(s).

Feature	Option	Description
SATA Controller(s)	[Enabled], [Disabled]	Select whether to enable or disable SATA controller.
SATA Mode Selection	[AHCI]	Determines how SATA controller(s) operate.
Port 1	[Disabled], [Enabled]	Select whether to enable or disable SATA port 1.



Figure 56: BIOS Advanced Menu - USB Configuration

Aptio Setup – AMI					
Main	Advanced	Power	Boot	Security	Save & Exit
USB Configuration					
USB Devices: 1 Keyboard				→ ←: Select Screen ↑ ↓: Select Item Enter: Select +/-: Change Opt. F1: General Help F2: Previous Values F3: Optimized Defaults F4: Save & Exit ESC: Exit	
Legacy USB Support		[Enabled]			
XHCI Hand-off		[Disabled]			
USB Mass Storage Driver Support		[Enabled]			
Version 2.22.1282 Copyright (C) 2023 AMI					

Feature	Option	Description
Legacy USB Support	[Enabled], [Disabled], [Auto]	Enables Legacy USB support. AUTO option disables legacy support if no USB devices are connected.
XHCI Hand-off	[Enabled], [Disabled]	This is a workaround for OSES without XHCI hand-off support. The XHCI ownership change should be claimed by XHCI driver.
USB Mass Storage Driver Support	[Disabled], [Enabled]	Enable / Disable USB Mass Storage Driver Support.

Figure 57: BIOS Advanced Menu - Trusted Computing

Aptio Setup – AMI					
Main	Advanced	Power	Boot	Security	Save & Exit
Configuration					
Security Device Support		[Disabled]			
No Security Device Found				→ ←: Select Screen ↑ ↓: Select Item Enter: Select +/-: Change Opt. F1: General Help F2: Previous Values F3: Optimized Defaults F4: Save & Exit ESC: Exit	
Version 2.22.1282 Copyright (C) 2023 AMI					

Feature	Option	Description
Security Device Support	[Disabled], [Enabled]	Enable or Disable BIOS support for security device. O.S. will not show Security Device. TCG EFI protocol and INT1A interface will not be available.

Figure 58: BIOS Advanced Menu – PSE Configuration

Aptio Setup – AMI					
Main	Advanced	Power	Boot	Security	Save & Exit
PSE Configuration					
Note: The Intel® PSE only supports the linux					
PSE Controller				[Disabled]	
CAN0*				[Disabled]	
CAN1*				[Disabled]	
SPI1*				[Disabled]	
				→ ←: Select Screen ↑ ↓: Select Item Enter: Select +/-: Change Opt. F1: General Help F2: Previous Values F3: Optimized Defaults F4: Save & Exit ESC: Exit	
Version 2.22.1282 Copyright (C) 2023 AMI					

\* These items appear only when enabling PSE Controller.

Feature	Option	Description
PSE Controller	[Disabled], [Enabled]	Enables / Disables Programmable Service Engine (PSE) Device
CAN0	[Disabled], [Enabled]	To assign this device to Enable or Disable.
CAN1	[Disabled], [Enabled]	To assign this device to Enable or Disable.
SPI1	[Disabled], [Enabled]	To assign this device to Enable or Disable.

Figure 59: BIOS Advanced Menu - Network Stack

Aptio Setup – AMI					
Main	Advanced	Power	Boot	Security	Save & Exit
Network Stack		[Disabled]			
IPv4 PXE Support*		[Enabled]			
IPv6 PXE Support*		[Disabled]			
				→ ←: Select Screen ↑ ↓: Select Item Enter: Select +/-: Change Opt. F1: General Help F2: Previous Values F3: Optimized Defaults F4: Save & Exit ESC: Exit	
Version 2.22.1282 Copyright (C) 2023 AMI					

\* These items appear only when enabling Network Stack.

Feature	Option	Description
Network Stack	[Disabled], [Enabled]	Enable / Disable UEFI Network Stack.
IPv4 PXE Support	[Disabled], [Enabled]	Enable / Disable IPv4 PXE boot support. If disabled, IPv4 PXE boot support will not be available.
IPv6 PXE Support	[Disabled], [Enabled]	Enable / Disable IPv6 PXE boot support. If disabled, IPv6 PXE boot support will not be available.

Figure 60: BIOS Advanced Menu - H/W Monitor

Aptio Setup – AMI					
Main	Advanced	Power	Boot	Security	Save & Exit
PC Health Status					
> Smart FAN Configuration					
System Temperature		: +41 C			
CPU Temperature		: +47 C			
CPU Fan Speed		: N/A		→ ←: Select Screen	
+V CORE		: +1.616 V		↑ ↓: Select Item	
+12V		: +11.956 V		Enter: Select	
+3.3V		: +3.424 V		+/-: Change Opt.	
+5V		: +5.146 V		F1: General Help	
+VMEM		: +1.245 V		F2: Previous Values	
+VRTC		: +3.172 V		F3: Optimized Defaults	
				F4: Save & Exit	
				ESC: Exit	
Version 2.22.1282 Copyright (C) 2023 AMI					

Figure 61: BIOS Advanced Menu - H/W Monitor - Smart FAN Configuration

Aptio Setup – AMI					
Main	Advanced	Power	Boot	Security	Save & Exit
Smart FAN Configuration					
CPU FAN Setting		[Manual]			
Manual Duty*		255		→ ←: Select Screen	
1st Boundary Temperature**		30		↑ ↓: Select Item	
1st FAN Speed**		50		Enter: Select	
2nd Boundary Temperature**		40		+/-: Change Opt.	
2nd FAN Speed**		100		F1: General Help	
3rd Boundary Temperature**		50		F2: Previous Values	
3rd FAN Speed**		150		F3: Optimized Defaults	
4th Boundary Temperature**		60		F4: Save & Exit	
4th FAN Speed**		200		ESC: Exit	
Version 2.22.1282 Copyright (C) 2023 AMI					

\* This item appears only when selecting Manual for CPU FAN Setting.

\*\* These items appear only when selecting Smart for CPU FAN Setting.

Feature	Option	Description
CPU FAN Setting	[Manual], [Smart]	Switch the CPU FAN control mode.

Feature	Option	Description
Manual Duty	Value Input	0 – 255 PWM Duty
1st / 2nd / 3rd / 4th Boundary Temperature	Value Input	1 – 100 C
1st / 2nd / 3rd / 4th FAN Speed	Value Input	0 – 255 PWM Duty

Figure 62: BIOS Advanced Menu - DIO Configuration

Aptio Setup – AMI					
Main	Advanced	Power	Boot	Security	Save & Exit
DIO Configuration					
User Configuration		[Disabled]			
DIO_0*		[Output High]			
DIO_1*		[Output High]			
DIO_2*		[Output High]			
DIO_3*		[Output High]			
DIO_4*		[Output High]			
DIO_5*		[Output High]			
DIO_6*		[Output High]			
DIO_7*		[Output High]			
→ ←: Select Screen					
↑ ↓: Select Item					
Enter: Select					
+/-: Change Opt.					
F1: General Help					
F2: Previous Values					
F3: Optimized Defaults					
F4: Save & Exit					
ESC: Exit					
Version 2.22.1282 Copyright (C) 2023 AMI					

\* These items appear only when enabling User Configuration.

Feature	Option	Description
User Configuration	[Enabled], [Disabled]	User can set the DO pin output value.
DIO_0..7	[Output Low], [Output High], [Input]	Setting the DO pin output value.

### 8.2.3. Power Setup Menu

The Power setup menu provides functions and a sub-screen for power configurations. The following sub-screen function is included in the menu:

- ▶ WatchDog Timer Configuration

Figure 63: BIOS Power Setup Menu

Aptio Setup – AMI					
Main	Advanced	Power	Boot	Security	Save & Exit
Power Configuration					
ACPI Sleep State		[S3 (Suspend to RAM)]			
Restore AC Power Loss		[Power Off]			
Power Saving Mode		[Disabled]			
Resume Event Control				→ ←: Select Screen	
Resume By LAN Device		[Disabled]		↑ ↓: Select Item	
Resume By Ring Device		[Disabled]		Enter: Select	
Resume By RTC Alarm		[Disabled]		+/-: Change Opt.	
Date(Days)Alarm*		0		F1: General Help	
Time(hh)Alarm*		0		F2: Previous Values	
Time(mm)Alarm*		1		F3: Optimized Defaults	
Time(ss)Alarm*		0		F4: Save & Exit	
> WatchDog Timer Configuration				ESC: Exit	
Version 2.22.1282 Copyright (C) 2023 AMI					

\* These items appear only when enabling Resume By RTC Alarm.

Feature	Option	Description
ACPI Sleep State	[S3 (Suspend to RAM)]	Read only item.
Restore AC Power Loss	[Power Off], [Power On], [Last State]	Select AC power state when power is re-applied after a power failure.
Power Saving Mode	[Disabled], [EUP Enabled]	Configure the Power Saving Mode configuration.
Resume By LAN Device	[Disabled], [Enabled]	Select whether to enable Wake from LAN Device.
Resume By Ring Device	[Disabled], [Enabled]	Select whether to enable Wake from Ring Device.
Resume By RTC Alarm	[Disabled], [Enabled]	Select whether to enable Wake Up on Alarm, to turn on your system on a special day of the month.
Date(Days)Alarm	Value Input	0 – 31, 0 stands for every day.
Time(hh)Alarm	Value Input	0 – 23
Time(mm)Alarm	Value Input	0 – 59
Time(ss)Alarm	Value Input	0 – 59



Figure 64: BIOS Power Setup Menu - WatchDog Timer Configuration

Aptio Setup – AMI					
Main	Advanced	Power	Boot	Security	Save & Exit
WatchDog Timer Configuration					
WDT Function		[Disabled]		→ ←: Select Screen	
WDT Count Mode*		[Second]		↑ ↓: Select Item	
WDT Timer*		30		Enter: Select	
				+/-: Change Opt.	
				F1: General Help	
				F2: Previous Values	
				F3: Optimized Defaults	
				F4: Save & Exit	
				ESC: Exit	
Version 2.22.1282 Copyright (C) 2023 AMI					

\* These items appear only when enabling WDT Function.

Feature	Option	Description
WDT Function	[Disabled], [Enabled]	Select whether to enable or disable WatchDog Timer function.
WDT Count Mode	[Second], [Minute]	Select WatchDog Count Mode: Second or Minute.
WDT Timer	Value Input	Count 0 – 255

## 8.2.4. Boot Setup Menu

The boot setup menu lists the for boot device priority order, that is generated dynamically.

Figure 65: BIOS Boot Setup Menu

Aptio Setup – AMI					
Main	Advanced	Power	Boot	Security	Save & Exit
Boot Configuration					
Full Screen LOGO Display		[Disabled]			
Setup Prompt Timeout		1		→ ←: Select Screen	
Bootup NumLock State		[On]		↑ ↓: Select Item	
Boot Option Priorities				Enter: Select	
				+/-: Change Opt.	
				F1: General Help	
				F2: Previous Values	
				F3: Optimized Defaults	
				F4: Save & Exit	
				ESC: Exit	
Version 2.22.1282 Copyright (C) 2023 AMI					

Feature	Option	Description
Full Screen LOGO Display	[Disabled], [Enabled]	Select whether to enable or disable to display logo screen.
Setup Prompt Timeout	Value Input	Number of seconds to wait for setup activation key. 65535(0xFFFF) means indefinite waiting.
Bootup NumLock State	[On], [Off]	This field indicates the state of the NumLock feature of the keyboard after Startup. [On]: The keys on the keypad will act as numeric keys. [Off]: The keys on the keypad will act as cursor keys.

## 8.2.5. Security Setup Menu

The Security setup menu provides information about the passwords and functions for specifying the security settings. The passwords are case-sensitive. The 3.5"-SBC-EKL provides no factory-set passwords.

### NOTICE

If there is already a password installed, the system asks for this first. To clear a password, simply enter nothing and acknowledge by pressing <RETURN>. To set a password, enter it twice and acknowledge by pressing <RETURN>.

Figure 66: BIOS Security Setup Menu

Aptio Setup – AMI					
Main	Advanced	Power	Boot	Security	Save & Exit
Password Description					
If ONLY the Administrator's password is set, then this only limits access to Setup and is only asked for when entering Setup					
If ONLY the User's password is set, then this is a power on password and must be entered to boot or enter Setup. In Setup the User will have Administrator rights					
The password length must be in the following range:					
Minimum Length		3		→ ←: Select Screen	
Maximum length		20		↑ ↓: Select Item	
Administrator Password				Enter: Select	
User Password				+/-: Change Opt.	
> Secure Boot				F1: General Help	
				F2: Previous Values	
				F3: Optimized Defaults	
				F4: Save & Exit	
				ESC: Exit	
Version 2.22.1282 Copyright (C) 2023 AMI					

Feature	Description
Administrator Password	Set administrator password
User Password	Set user password



If only the administrator's password is set, then only access to setup is limited. The password is only entered when entering setup.

If only the user's password is set, then the password is a power on password and must be entered to boot or enter setup. Within the setup menu the user has administrator rights.

Password length requirements are maximum 20 characters and minimum 3 characters.

Figure 67: BIOS Security Setup Menu – Secure Boot

Aptio Setup – AMI					
Main	Advanced	Power	Boot	Security	Save & Exit
System Mode		Setup			
Secure Boot		[Disabled]		→ ←: Select Screen	
		Not Active		↑ ↓: Select Item	
Secure Boot Mode		[Standard]		Enter: Select	
> Restore Factory Keys*				+/-: Change Opt.	
> Reset To Setup Mode*				F1: General Help	
				F2: Previous Values	
> Key Management*				F3: Optimized Defaults	
				F4: Save & Exit	
				ESC: Exit	
Version 2.22.1282 Copyright (C) 2023 AMI					

\*These items are selectable only when selecting Custom for Secure Boot Mode.

Feature	Option	Description
Secure Boot	[Disabled], [Enabled]	Secure Boot feature is Active if Secure Boot is Enabled, Platform Key (PK) is enrolled and the System is in User mode. The mode change requires platform reset.
Secure Boot Mode	[Standard], [Custom]	Secure Boot mode options: Standard or Custom. In Custom mode, Secure Boot Policy variables can be configured by a physically present user without full authentication.
Restore Factory Keys	[Yes], [No]	Force System to User Mode. Install factory default Secure Boot key databases.
Reset to Setup Mode	[Yes], [No]	Delete all Secure Boot key databases from NVRAM.

Figure 68: BIOS Security Setup Menu – Secure Boot – Key Management

Aptio Setup – AMI						
Main	Advanced	Power	Boot	Security	Save & Exit	
Vendor Keys		Valid				
Factory Key Provision		[Disabled]				
> Restore Factory Keys						
> Reset To Setup Mode						
> Export Secure Boot variables						
> Enroll Efi Image						
Device Guard Ready						
> Remove 'UEFI CA' from DB						
> Restore DB defaults						→ ←: Select Screen ↑ ↓: Select Item
Secure Boot variable		Size	Keys	Key Source	Enter: Select	
> Platform Key (PK)		0	0	No Keys	+/-: Change Opt.	
> Key Exchange Keys		0	0	No Keys	F1: General Help	
> Authorized Signatures		0	0	No Keys	F2: Previous Values	
> Forbidden Signatures		0	0	No Keys	F3: Optimized Defaults	
> Authorized TimeStamps		0	0	No Keys	F4: Save & Exit	
> OsRecovery Signatures		0	0	No Keys	ESC: Exit	
Version 2.22.1282 Copyright (C) 2023 AMI						

Feature	Option	Description
Factory Key Provision	[Disabled], [Enabled]	Install factory default Secure Boot keys after the platform reset and while the System is in Setup mode.
Reset Factory Keys	[Yes], [No]	Force System to User Mode. Install factory default Secure Boot key databases.
Reset to Setup Mode	[Yes], [No]	Delete all Secure Boot key databases from NVRAM.
Export Secure Boot variables	Select a File system	Copy NVRAM content of Secure Boot variables to files in a root folder on a file system device.
Enroll Efi Image	Select a File system	Allow the image to run in Secure Boot mode. Enroll SHA256 Hash certificate of a PE image into Authorized Signature Database (db).
Remove 'UEFI CA' from DB	[Yes], [No]	Device Guard ready system must not list 'Microsoft UEFI CA' Certificate in Authorized Signature database (db).
Restore DB defaults	[Yes], [No]	Restore DB variable to factory defaults.
Platform Key (PK)	[Details], [Export], [Update], [Delete]	Enroll Factory Defaults or load certificates from a file: 1. Public Key Certificate: (a) EFI_SIGNATURE_LIST (b) EFI_CERT_X509 (DER)

Feature	Option	Description
Key Exchange Keys	[Details], [Export], [Update], [Append], [Delete]	(c) EFI_CERT_RSA2048 (bin) (d) EFI_CERT_SHAXXX 2. Authenticated UEFI Variable 3. EFI PE / COFF Image (SHA256) Key Source: Factory, External, Mixed
Authorized Signatures	[Details], [Export], [Update], [Append], [Delete]	
Forbidden Signatures	[Details], [Export], [Update], [Append], [Delete]	
Authorized TimeStamps	[Update], [Append]	
OsRecovery Signatures	[Update], [Append]	

### 8.2.5.1. Remember the password

It is highly recommended to keep a record of all passwords in a safe place. Forgotten passwords results in being locked out of the system.

If the system cannot be booted because the User Password or the Supervisor Password are not known, contact Kontron Support for further assistance.



---

**HDD security passwords cannot be cleared using the above method.**

---

## 8.2.6. Save & Exit Setup Menu

The exit setup menu provides functions for handling changes made to the UEFI BIOS settings and the exiting of the setup program.

Figure 69: BIOS Save & Exit Setup Menu

Aptio Setup – AMI					
Main	Advanced	Power	Boot	Security	Save & Exit
Save Changes and Reset					
Discard Changes and Reset					
Save Options				→ ←: Select Screen	
Save Changes				↑ ↓: Select Item	
Discard Changes				Enter: Select	
Restore Defaults				+/-: Change Opt.	
				F1: General Help	
				F2: Previous Values	
				F3: Optimized Defaults	
				F4: Save & Exit	
				ESC: Exit	
Version 2.22.1282 Copyright (C) 2023 AMI					

Feature	Description
Save Changes and Reset	Reset the system after saving the changes.
Discard Changes and Reset	Reset system setup without saving any changes.
Save Changes	Save Changes done so far to any of the setup options.
Discard Changes	Discard Changes done so far to any of the setup options.
Restore Defaults	Restore / Load Default values for all the setup options.



## Appendix A: List of Acronyms



The following table does not contain the complete acronyms used in signal names, signal type definitions or similar. A description of the signals is included in the I/O Connector and Internal connector chapters within this user guide.

Table 57: List of Acronyms

2D	Two-Dimensional
3D	Three-Dimensional
AT	Advanced Technology
ATX	Advanced Technology eXtended
BGA	Ball Grid Array
BIOS	Basic Input / Output System
BSP	Board Support Package
CMOS	Complementary Metal Oxide Semiconductor
CPU	Central Processing Unit
DC	Direct Current
DDC	Display Data Channel
DIO	Digital Input / Output
DP	DisplayPort
ECC	Error-Correcting Code
EEE	Electrical and Electronic Equipment
EOS	Electrical OverStress
ESD	ElectroStatic Discharge
GbE	Gigabit Ethernet
HDD	Hard Disk Drive
HDMI	High Definition Multimedia Interface
LAN	Local Area Network
LED	Light Emitting Device
LVDS	Low-Voltage Differential Signaling
ME F/W	Management Engine Firmware
mPCIe	mini Peripheral Component Interconnect express
NGFF	Next Generation Form Factor
PC-AT	Personal Computer - Advanced Technology
PCB	Printed Circuit Board
PSU	Power Supply Unit
PVC	PolyViny Chloride
PWM	Pulse Width Modulation
RAM	Random Access Memory
ROM	Read-Only Memory

RTC	Real-Time Clock
SATA	Serial Advanced Technology Attachment
SD	Secure Digital memory card
SDP	Serial Download Protocol
SELV	Safety Extra-Low Voltage
SIM	Subscriber Identity Module
SMBus	System Management Bus
SoC	System on Chip
SO-DIMM	Small Outline Dual In-line Memory Module
SPD	Serial Presence Detect
SPI	Serial Peripheral Interface
TDP	Thermal Design Power
TPM	Trusted Platform Module
UEFI	Unified Extensible Firmware Interface
USB	Universal Serial Bus
UTP	Update Transfer Protocol
VGA	Video Graphics Array
WDT	WatchDog Timer
WEEE	Waste Electrical and Electronic Equipment



## About Kontron

Kontron is a global leader in IoT / Embedded Computing Technology (ECT) and offers individual solutions in the areas of Internet of Things (IoT) and Industry 4.0 through a combined portfolio of hardware, software and services. With its standard and customized products based on highly reliable state-of-the-art technologies, Kontron provides secure and innovative applications for a wide variety of industries. As a result, customers benefit from accelerated time-to-market, lower total cost of ownership, extended product lifecycles and the best fully integrated applications.

For more information, please visit: [www.kontron.com](http://www.kontron.com)



## Global Headquarters

### Kontron Europe GmbH

Gutenbergstraße 2  
85737 Ismaning  
Germany  
Tel.: +49 821 4086-0  
Fax: +49 821 4086-111  
[info@kontron.com](mailto:info@kontron.com)